

# H709



# Hawkeye® 709

## Adjustable Solid-Core Current Switch with 120VAC/DC Output

### Installer's Specifications

Amperage Range	1 to 135A Continuous*
Sensor Supply Voltage	Induced from monitored conductor
Isolation	600VAC rms.
Temperature Range	-15° to 60° C
Humidity Range	10-90% RH non-condensing
Status Output	N.O. 200mA@120VAC/DC
On-State Resistance (max)	20 ohms
Off-State Resistance (min)	1 megohm

\*When operating at 50Hz, low threshold may be 1.2A

### QUICK INSTALL

1. Plan the installation:  
Locate a mounting surface for the removable mounting bracket that will allow the monitored conductor to pass through the iris, or "window" when it is installed. Determine cable routing for the controller connection, allowing wiring to reach the mounting location.
2. Install mounting bracket  
Drill holes to mount the bracket to the chosen surface using the included screws.
3. Wire the output connections between the sensor and the controller (solid-state contact) or external power supply.
4. Route the wire to be monitored through the product iris and slip the assembly into the mounting bracket.
5. Calibrate the sensor (see page 2) with the load running normally.
6. Close up and power up!

### DIMENSIONS

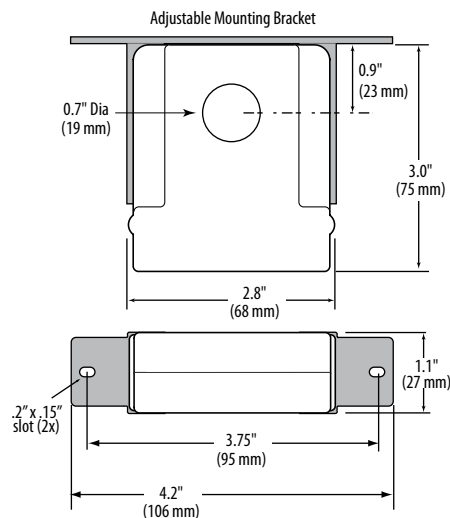

## ⚠ DANGER ⚡

### HAZARD OF ELECTRIC SHOCK, EXPLOSION, OR ARC FLASH

- Follow safe electrical work practices. See NFPA 70E in the USA, or applicable local codes.
- This equipment must only be installed and serviced by qualified electrical personnel.
- Read, understand and follow the instructions before installing this product.
- Turn off all power supplying equipment before working on or inside the equipment.
- Use a properly rated voltage sensing device to confirm power is off. DO NOT DEPEND ON THIS PRODUCT FOR VOLTAGE INDICATION
- Only install this product on insulated conductors.

Failure to follow these instructions will result in death or serious injury.

## NOTICE

- This product is not intended for life or safety applications.
- Do not install this product in hazardous or classified locations.
- The installer is responsible for conformance to all applicable codes.
- Mount this product inside a suitable fire and electrical enclosure.

### Wiring Example

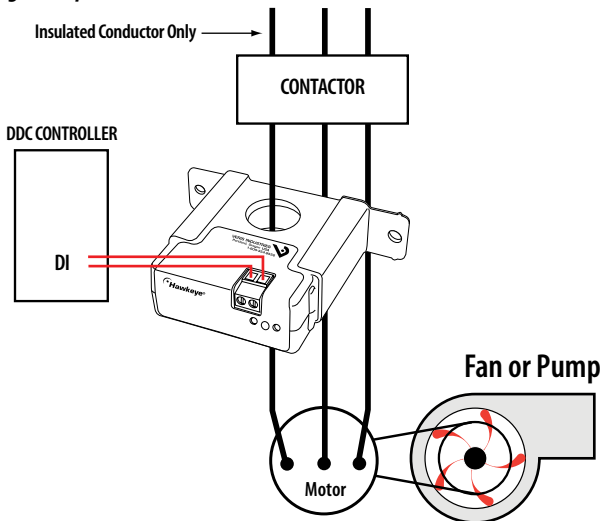

**OPERATION**

The H709 is a current-sensitive switching device which monitors current (amperage) in the conductor passing through it. A change in amperage in the monitored conductor which crosses the switch (setpoint) threshold plus the hysteresis value will cause the resistance of the status output to change state, similar to the action of a mechanical switch. In this model, the setpoint is adjustable through the action of a twenty (20) turn potentiometer (see the CALIBRATION section). The status output is suitable for connection to building controllers, or other appropriate data acquisition equipment operating at up to 120 volts. The H709 requires no external power supply to generate its output.

**NOTES**

**For load currents greater than sensor maximum rating:**

Use a 5 Amp (H681x series) Current Transformer (CT) as shown. External power supply not shown.

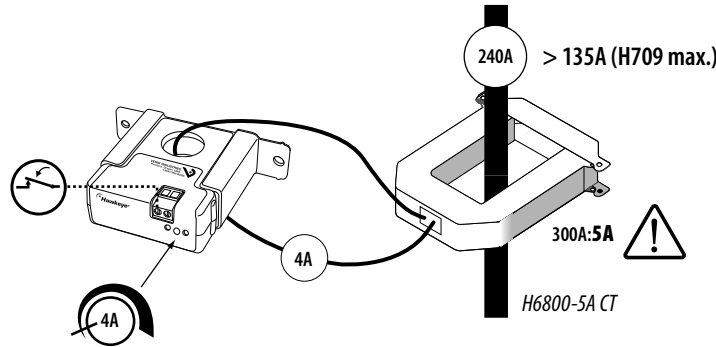

**DANGER:** 5A CTS CAN PRESENT HAZARDOUS VOLTAGES. INSTALL CTS IN ACCORDANCE WITH MANUFACTURER'S INSTRUCTIONS. TERMINATE THE CT SECONDARY BEFORE APPLYING CURRENT.

**CAUTION**

**RISK OF EQUIPMENT DAMAGE**

- Derate the product's maximum current for the number of turns through the sensing window using the following formula.  

$$\text{Rated Max. Amps} \div \text{Number of Turns} = \text{Max. monitored Amps}$$
 e.g. :  $100A \div 4 \text{ Turns} = 25 \text{ Amps max. in monitored conductor}$
- Failure to follow these instructions can result in overheating and permanent equipment damage.

**For load currents less than sensor minimum rating:**

Wrap the monitored conductor through the center hole and around the sensor body to produce multiple turns through the "window." This increases the current measured by the sensor.

- Controller must be programmed to account for the extra turns. e.g., if four turns pass through the sensor (as shown) the normal reading must be divided by 4.

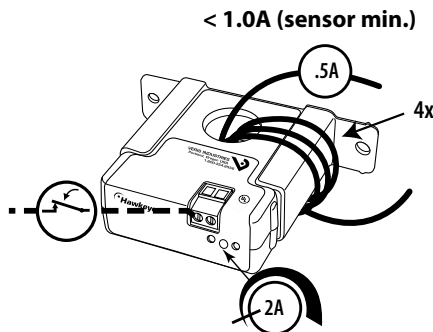

**CALIBRATION**

Establish normal load conditions.

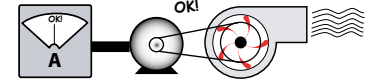

**A. To monitor under-current (belt loss, coupling shear, status)**

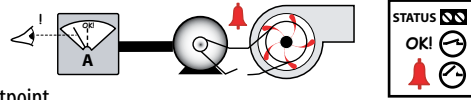

Find Setpoint adjustment screw

1. Turn setpoint screw clockwise until Status OPEN LED turns ON.



2. S-l-o-w-l-y turn the screw counter-clockwise until the Status CLOSED LED just turns ON.

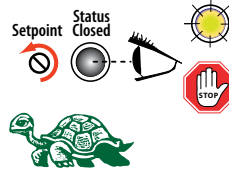

3. Setpoint Turn the screw an additional 1/4 turn counter-clockwise for operational margin.

**B. To monitor over-current (mechanical problems, seized impeller)**

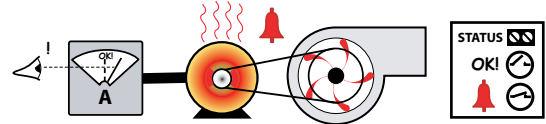

Find Setpoint adjustment screw

1. Turn setpoint screw counter-clockwise until Status CLOSED LED turns ON.



2. S-l-o-w-l-y turn the setpoint screw clockwise until the Status OPEN LED just turns ON.

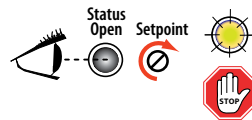

3. Turn the setpoint screw an additional 1/4 turn clockwise for operational margin.

**TROUBLESHOOTING**

Problem	Solution
No Reading at Controller	<ul style="list-style-type: none"> <li>• Check sensor calibration (see above)</li> <li>• Check that power at the contact has not exceeded 120VAC/DC and 0.2A</li> <li>• Check for amperage in monitored conductor (&gt; 1.0A)</li> </ul>
Setpoint screw has no stops	<ul style="list-style-type: none"> <li>• The setpoint screw has a slip-clutch at both ends of its travel to avoid damage. Twenty turns CCW will reset the sensor to be most sensitive. Repeat calibration above.</li> </ul>
Both LEDs are lit	Unit is out of calibration. Turn screw 20 turns CCW and recalibrate.