



Features & Options

- Wall and Ceiling Ports That Are Economical & Easy to Install
- Includes 80 Micron Sintered SS Filter To Prevent Insects or Debris from Entering or Plugging the Tubing
- Accommodates 1/8" I.D. to 5/32" I.D. Tubing



- Modern BAPI-Stat "Quantum" Enclosure Style on Room Ports
- Low Profile "Button" Pickup Port That Is Smaller Than a Quarter in Size and Blends In With Its Surroundings



Wall Plate

Low Profile Port

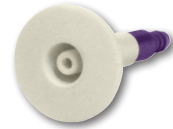

Ceiling Mount Square Cover



BAPI-Stat "Quantum"
(Right unit shown with 60mm mounting base for European wall boxes. Unit is also available with a temp sensor.)

Specifications

Environmental Operating Range:

Wall & Ceiling Plates: 32 to 122°F (0 to 50°C) • 0% to 95% RH, non-condensing

Low Profile Port: -40 to 185°F (-40 to 85°C) • 0% to 100% RH, non-condensing

Material:

Quantum, Delta Style & Low Profile:
ABS Plastic, UL 94, V-0

Wall Plate:
Stainless Steel

Ceiling Plate:
Galvanized Steel

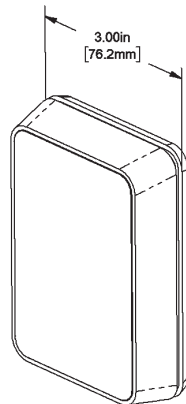

BAPI-Stat "Quantum" Enclosure
(with standard mounting base)

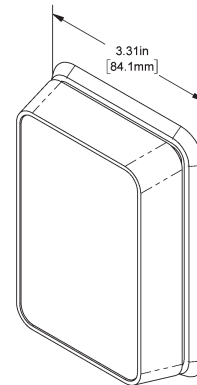

BAPI-Stat "Quantum" Enclosure
(with optional 60mm mounting base for European wall boxes)

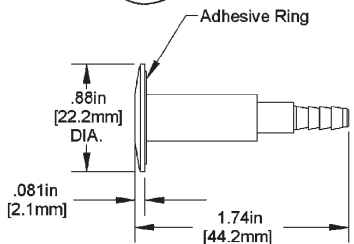
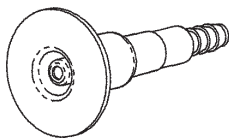

Low Profile Port

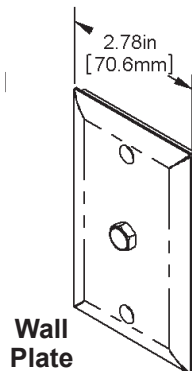

Wall Plate

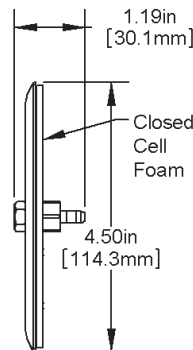

Ceiling Mount Cover

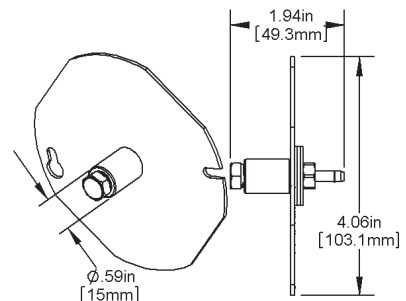



Submittal sheets without List Prices are available on our website at www.bapihvac.com

Use the Option Selection Guide below to create your custom part number. Replace the number and brackets with the designator for each selection. Skip the designator and dashes for optional selections that are not required in your configuration.

Pressure Pickup Ports Option Selection Guide

ZPS-ACC (#1) - (#2)

#1: Pickup Port (required)

01.....	2" X 4" Stainless Steel Wall Plate with Static Pickup	\$18
04.....	BAPI-Stat "Quantum" with Static Pickup, standard mounting base	\$15
04-60	BAPI-Stat "Quantum" with Static Pickup, 60mm mounting base	\$15
05.....	Ceiling Mount Square Cover with Static Pickup.....	\$15
20.....	Low Profile Pressure Pickup Port.....	\$30

#2: Temperature Sensor (optional, not available for 05 and 20 above)

18.....	1.8K Thermistor	\$18
3.....	3K Thermistor	\$18
102.....	10K-2 Thermistor.....	\$18
103.....	10K-3 Thermistor.....	\$18
10311.....	10K-3[11K] Thermistor.....	\$18
20.....	20K Thermistor	\$18
1375.....	1K Platinum RTD (375 curve).....	\$25
1.....	1K Platinum RTD (385 curve).....	\$25

Additional temperature sensors are available for these units but not shown in this Selection Guide. Contact your BAPI representative for the complete list of options. Submittal sheets without List Prices can be downloaded from our website at www.bapihvac.com

Example Number: ZPS-ACC(04) - (102)

Actual Number (with parenthesis removed): ZPS-ACC04-102

Description: BAPI-Stat "Quantum" Style Enclosure with Static Pickup, 10K-2 Thermistor Temperature Sensor.

List Price: \$15 (BAPI-Stat "Quantum" Style Enclosure) + \$18 (Thermistor) = \$33 List Price

Your Number: ZPS/ACC

