

Thermowells

for Industrial Thermometers

All dimensions are nominal. Dimensions in [] are in millimeters.

THERMOWELLS

- SX9 Solar
- AX9, BX9, CX9 Adjustable Angle
- AX, BX, CX Rigid Stem
- BX Plus

Lengths

(A) Stem Length	Standard	with Lagging Extension	
	U Length	(T)	U Length
3 1/2"	2.50 [64]	1.00 [25]	1.75 [44]
6"	5.00 [127]	3.00 [76]	2.50 [64]
8"	7.00 [178]	3.00 [76]	4.50 [114]
12"	11.00 [279]	3.00 [76]	8.50 [216]

Pressure Rating (psi)

Material	Operating Temperature			
	70°F	200°F	400°F	600°F
304 Stainless Steel	630	570	460	380
316 Stainless Steel	650	600	570	500
Monel	540	480	440	400
Brass/PBF Brass	300 psi @ 150°F, 250 psi @ 350°F			

Standard

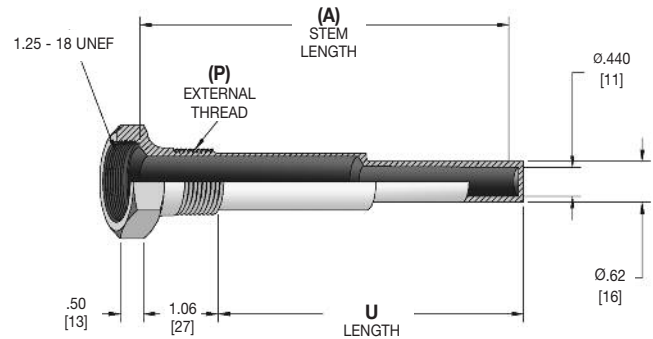

with Lagging Extension

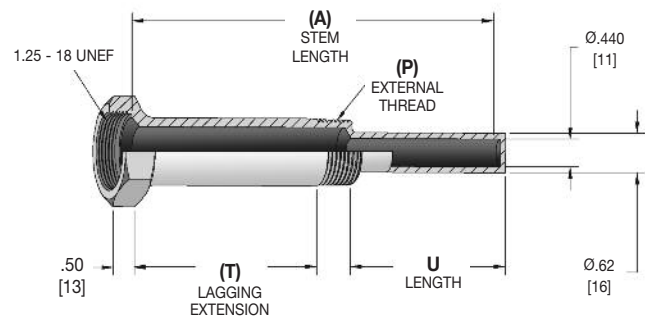

Alternative materials and accessories are also available. Please consult the Options and Accessories Section for details.

Selection of the proper thermowell is the sole responsibility of the user. Temperature and pressure limitations must be considered. Improper application may cause failure of the thermowell, resulting in possible personal injury or property damage.

HOW TO ORDER

Sample Order Number: **3-4 F 2**

Thermowell Style	(P) External Thread	(A) Stem Length	(T) Lagging Extension	Material
3 - Industrial	3 1/2 NPT*	F 3 1/2" Stem**	A 1" Extension (3 1/2" Stem only)	2 Brass††
	4 3/4 NPT	J 6" Stem	D 2 1/2" Extension (6" and longer Stem only)	4 Monel
	5 1 NPT	L 8" Stem	Omit if None	5 304SS
		R 12" Stem†		6 316SS

* Only available with 3 1/2" stem and 1" extension.

** 3 1/2" stem Straight Shank.

† 12" stem requires 1 NPT external thread.

†† Add (PBF) to end of part number to specify Lead-Free brass