

T7350 Commercial Programmable Thermostat

FOR SINGLE- OR MULTI-STAGE CONVENTIONAL/
HEAT PUMP SYSTEMS

INSTALLATION INSTRUCTIONS

APPLICATION

The T7350 Commercial Programmable Thermostat controls 24 Vac commercial single zone heating, ventilating and air conditioning (HVAC) equipment. The T7350 consists of a thermostat and subbase. The thermostat includes the display and keypad for 7-day programming. The subbase includes equipment control connections. The subbase mounts on the wall and the thermostat mounts to the subbase.



MERCURY NOTICE

If this control is replacing a control that contains mercury in a sealed tube, do not place your old control in the trash. Dispose of properly.

Contact your local waste management authority for instructions regarding recycling and the proper disposal of an old control. If you have questions, call Honeywell Customer Care Center at 1-800-468-1502.

INSTALLATION

When Installing this Product...

1. Read these instructions carefully. Failure to follow them could damage the product or cause a hazardous condition.
2. Check ratings given in instructions and on the product to ensure the product is suitable for your application.
3. Installer must be a trained, experienced service technician.
4. After installation is complete, check out product operation as provided in these instructions.



CAUTION

Electrical Shock or Equipment Damage Hazard.
Can shock individuals or short equipment circuitry.
Disconnect power supply before installation.

Location

Do not install the thermostat where it can be affected by:

- drafts or dead spots behind doors and in corners.
- hot or cold air from ducts.
- radiant heat from sun or appliances.
- concealed pipes and chimneys.
- unheated (uncooled) areas such as an outside wall behind the thermostat.

IMPORTANT

To avoid electrical interference, which can cause erratic performances, keep wiring runs as short as possible and do not run thermostat wires adjacent to the line voltage electrical distribution systems. Use shielded cable. The cable shield must be grounded only at the controlled equipment case.

Subbase

WHEN USED TO SENSE ROOM TEMPERATURE

Install the thermostat about 5 ft. (1.5m) above the floor in an area with good air circulation at average temperature. (See Fig. 1.)

WHEN NOT USED TO SENSE ROOM TEMPERATURE

When using the remote-mounted temperature (and humidity) sensor(s) to sense ambient conditions, install the thermostat in an area that is accessible for setting and adjusting the temperature and settings.



CAUTION

Equipment Damage Hazard.
Can damage the TIM connection beyond repair.
Disconnect the TIM cable prior to opening or closing the thermostat cover.

NOTE: Allow sufficient clearance below the thermostat to plug in the TIM cable.

Install the remote-mounted sensor(s) about 5 ft. (1.5m) above the floor in an area with good air circulation at average temperature. (See Fig. 1.)

If multiple remote sensors are required, they must be arranged in a temperature averaging network consisting of four sensors. (See Fig. 2.)



NOTE: Only TR21 models with no setpoint adjustment can be used for temperature averaging.

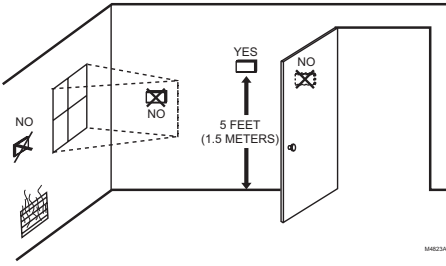

Fig. 1. Typical location of thermostat or remote-mounted sensor.

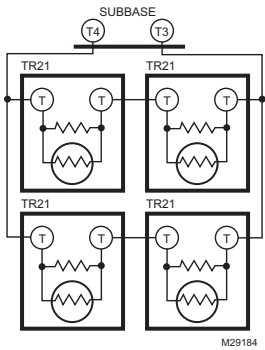

Fig. 2. Four TR21 sensors providing temperature averaging network for T7350 Thermostat.

Mounting Subbase

The subbase mounts horizontally.

IMPORTANT

- When using the internal temperature or humidity sensor, the device must be mounted horizontally (with the LCD facing upwards). Precise leveling is not needed.
- When using remote room temperature and humidity sensors, thermostat mounting orientation does not matter.

Wall mounting (using standard drywall screws) is standard. Mounting to a 2 in. by 4 in. (50.8 mm by 101.6 mm) wiring box can be accomplished:

- for a horizontal box, no extra hardware is required.
- for a vertical box, part 209651A is required.
- Mount to European standard wall box (having 2.4 in. (60.3 mm) between mounting screws in a horizontal line) with or without adaptive hardware.

1. Position and level the subbase.

NOTE: A level wallplate is only for appearance. The thermostat functions properly even when not level.

2. Use a pencil to mark the mounting holes. (See Fig. 3.)
3. Remove the subbase from the wall and drill two 3/16 in. (4.8 mm) holes in the wall (if drywall) as marked. For firmer material such as plaster or wood, drill two 7/32 in. (5.6 mm) holes.
4. Gently tap anchors (provided) into the drilled holes until flush with the wall.
5. Position the subbase over the holes, pulling wires through the wiring opening.
6. Loosely insert the mounting screws into the holes.
7. Tighten mounting screws.

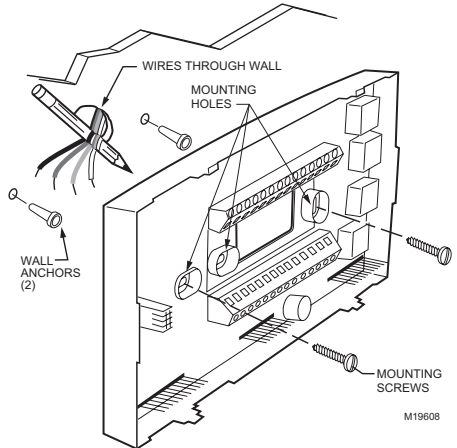

Fig. 3. Mounting the subbase.

Mounting Thermostat on Subbase (Fig. 4)

With the subbase installed, mount the thermostat:

1. Engage top subbase tabs into the thermostat top.
2. Swing the thermostat down.
3. Press the lower edge of the case to latch.

NOTE: To remove the thermostat from the wall, first pull out at the bottom of the thermostat; then remove the top.

Wiring

Follow equipment manufacturer wiring instructions when available. Refer to the Wiring Diagram section starting on page 8 for typical hookups. A letter code is located near each terminal for identification.

IMPORTANT

All wiring must comply with local electrical codes and ordinances.

NOTE: Maximum (and recommended) wire size is 18-gauge. Do not use wire smaller than 22-gauge.

1. Loosen subbase terminal screws and connect system wires.
2. Securely tighten each terminal screw.
3. Push excess wire back into the hole in the wall.
4. Plug the hole with nonflammable insulation to prevent drafts from affecting the thermostat.

A. ENGAGE TABS AT TOP OF THERMOSTAT AND SUBBASE OR WALLPLATE.

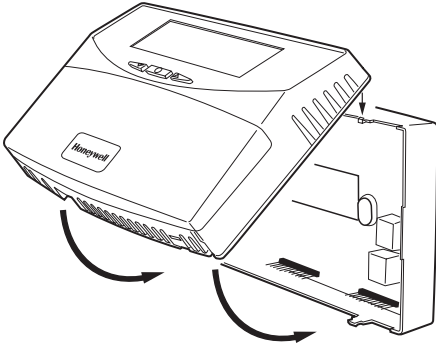

B. PRESS LOWER EDGE OF CASE TO LATCH.

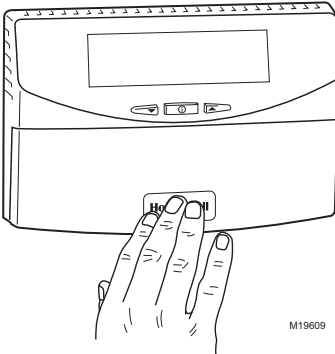

Fig. 4. Mounting thermostat on subbase.

Setting System and Fan

System default setting is Auto. Fan default setting is On.

NOTE: Use *System* and *Fan* keys to change settings.

System Settings

- Auto: Thermostat automatically changes between heating and cooling based on indoor temperature.
- Cool: Thermostat controls cooling.
- Off: Heating, cooling, and fan are all off.
- Heat: Thermostat controls heating.
- Em Heat: Auxiliary heat serves as first stage. Compressor stages are locked off.

Fan Settings

- On: See Table 1.
- Auto: Fan always cycles with call for heat or cool.
 - Conventional: The equipment (i.e. plenum switch) controls fan operation in heat mode. Thermostat controls fan operation in cool mode.
 - Electric Heat: Thermostat controls fan operation in both heat and cool modes.

NOTES: Fan operation can extend (delay Off) after the heating/cooling turns off:

- Heating choices are 0 or 90 seconds.
- Cooling choices are 0 or 40 seconds

Table 1. Intelligent™ Fan ON control logic

Scheduled Period	Occupancy		Call for Heat/Cool	
	Motion Sensor Signal	Effective Occupancy	Yes	No
Occupied	No Sensor Wired	Occupied	Fan On	Fan On
Occupied	Motion Sensed	Occupied	Fan On	Fan On
Occupied	No Motion Sensed	Standby	Fan On	Fan Off ^a
Standby	No Sensor Wired	Standby	Fan On	Fan Off ^a
Standby	Motion Sensed	Standby	Fan On	Fan Off ^a
Standby	No Motion Sensed	Standby	Fan On	Fan Off ^a
Not Occupied	No Sensor Wired	Not Occupied	Fan On	Fan Off ^a
Not Occupied	Motion Sensed	Occupied	Fan On	Fan Off ^a
Not Occupied	No Motion Sensed	Not Occupied	Fan On	Fan Off ^a

^a In heat mode, when set for conventional heat, the equipment (i.e. plenum switch) could power the fan despite the T7350.

SETTINGS

Using Thermostat Keys

The thermostat keys are used to:

- set current time and day,
- program times and setpoints for heating and cooling,
- override the program temperatures,
- display present setting,
- set system and fan operation,
- perform simple configuration.

NOTE: See Fig. 5 for keypad information.

Setting Temperature

Refer to Table 2 for the default temperature setpoints. See the Product Data (form 63-2605) for complete instructions on changing the setpoints.

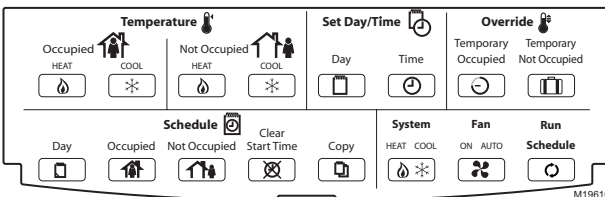

Fig. 5. Thermostat key locations.

INSTALLER SETUP

For most applications, the thermostat factory settings do not need to be changed. Review the factory settings in Table 2.

NOTE: When power is first applied to the thermostat, the display will show all segments (see Fig. 6).

Table 2. Default setpoints.

Control	Occupied	Not Occupied	Standby
Heating	70°F (21°C)	55°F (13°C)	67°F (19°C)
Cooling	75°F (24°C)	85°F (29°C)	78°F (26°C)

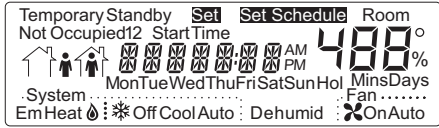

Fig. 6. LCD display of all segments.

CAUTION

Possible Equipment Damage.
Fan must be running when system is operating.

Heat pump and electric heat systems must be configured correctly to prevent equipment damage caused by the system running without the fan.

Setup Using Keypad

The installer uses the Installer Setup to customize the thermostat to specific systems. For basic setup functions, the thermostat can be configured using the keypad.

NOTE: The T7350 has serial communications to facilitate use of an installer configuration tool. More advanced features are available using this tool. (Refer to form 63-2605 for details.)

A combination of key presses are required to use the Installer Setup feature:

1. To enter the Installer Setup, press and hold both the *Run Schedule* and the *Copy* keys until DEG F (or DEG C) displays.
2. To advance to the next Installer Setup number, press **1**.

NOTE: Pressing *Run/Copy* again while in this mode displays the T7350 firmware version number.

3. To return to a Setup item, cycle through the options.
4. To change a setting, use the up ▲ or down ▼ key.
5. To exit the Installer Setup, press *Run Schedule*.
6. Display prompts SAV CFG (save configuration).
 - a. If you want to save the new configuration, use the up ▲ or down ▼ key to change NO to YES before pressing *Run Schedule*.
 - b. If you want the configuration to remain as it was before starting this change, ensure the display indicates SAV CFG NO and press *Run Schedule*.
4. Once the proper option is chosen, exit Installer

NOTE: Installer Setup is automatically exited after five minutes with no key pressed. Upon this automatic exit, all changes are lost.

Configuration

Limited configuration can be done with the keypad using the Configuration ID. In order to determine the proper codes to use for the Configuration Variables (CnfgID), spreadsheets of the CnfgID values are available online at <http://customer.honeywell.com/t7350>.

A PDA or Honeywell's TStatSpec™ software can be used, as well. Follow these instructions for identifying the CnfgID values using TStatSpec.

1. Open the TStatSpec™ software on your PC.
2. Create a new configuration or open an existing configuration.
3. Select the "Configuration Screen" button and configure the settings as desired.
4. Click on the "Configuration ID" button on the bottom left of the configuration screen.
5. Make note of the values.
6. Press both Copy and Run Schedule on the thermostat.
7. Tap **1** until C1 appears on the right end of the display.

NOTE: While stepping toward C1, check other items to ensure they are set properly. See Setup Using Keypad section.

8. To adjust each variable to match PDA indication:
 - a. Hold down the up ▲ or down ▼ key to adjust the value quickly.
 - b. Tap the up ▲ or down ▼ key for fine control.
9. Tap **1** to switch to another variable.
10. Return to step 8 and repeat the process until all configuration values are set properly.
11. To exit the Installer Setup, press *Run Schedule*.
12. Display prompts SAV CFG (save configuration).
 - a. If you want to save the new configuration, use the up ▲ or down ▼ key to change NO to YES before pressing *Run Schedule*.
 - b. If you want the configuration to remain as it was before starting this change, ensure the display indicates SAV CFG NO and press *Run Schedule*.

Setting Keypad Lockout

Proper keypad sequences activate the lockout features. To change the keypad lockout state:

1. Enter the Installer Setup; press and hold both the *Run Schedule* and the *Copy* keys until DEG F (or DEG C) displays.
2. Press **1** until KYLCK displays.
3. Use the up ▲ or down ▼ key to change the setting. Options are:
 - 0: No lockout.
 - 1: Lockout all keys except Temporary Occupied, Temporary Not Occupied, up ▲ or down ▼ and **1**.
 - 2: Lockout all keys except **1**.























NOTES:

- Options 1 and 2 do not allow adjustments on dehumidification high limit.
- No options lockout special keypress functions. See the Special Functions section for details.

Setup by pressing *Run Schedule*.

5. Display prompts SAV CFG. If you want to save it, use the up ▲ or down ▼ key to change NO to YES before pressing *Run Schedule* again.

Table 3. T7350 Key Function Summary.

Grouping	Button	Definition
Information	Down Arrow 	Lowers setpoint, day, or time. When setting times or temperatures, hold key down to continuously decrease value. Also can make temporary change in temperature setpoint.
	Information 	Obtains information (where humidity "high-limit" can be set), cycles through setup options.
	Up Arrow 	Raises setpoint, day, or time. When setting times or temperatures, hold key down to continuously increase value. Also can make temporary change in temperature setpoint.
Temperature 	Occupied Heat 	Sets Occupied Heat setpoint.
	Occupied Cool 	Sets Occupied Cool setpoint.
	Not Occupied Heat 	Sets Not Occupied Heat setpoint.
	Not Occupied Cool 	Sets Not Occupied Cool setpoint.
Set 	Day 	Sets day of week. Tapping key with 'Set Value' segment on increases current day (same effect as <i>Up Arrow</i> key).
	Time 	Sets time. Tapping key with "Set Value" segment on increases time in one hour increments.
Override 	Temporary Occupied 	Temporary occupied setting for length of time defined by installer. User can modify setpoints.
	Temporary Not Occupied 	Sets holiday length. User selects number of days ("0"-"99"), or "---" for continuous override.
Schedule 	Day 	Selects day schedule to modify. (Used also with copy key.)
	Occupied 	Selects occupied event start times for specified day. Repeatedly press this key to toggle between two occupied events.
	Not Occupied 	Selects not occupied event start times for specified day. Repeatedly press this key to toggle between two not occupied events.
	Clear Start Time 	Clears start time for specified period and day.
	Copy 	Copies schedule from one day to another.
	System 	Selects System Mode. Toggles through Em Heat, Heat, Off, Cool, and Auto.
	Fan 	Selects fan operation mode. Toggles between On and Auto. ^a
	Run Schedule 	Resumes running schedule (cancels Temporary Occupied action, Holiday, and/or Temporary setpoint changes.)

^a On: Continuous fan operation during occupied periods. During not occupied periods and standby, fan cycles with call for heat or cool.

Auto: Fan cycles with call for heat or cool during all periods. (See Product Data Sheet, form 63-2605, for more details.)

NOTES: The display returns to default screen after pressing Run Schedule (or after a period of time without keypress):

- ten seconds: when returning from temporary setpoint changes, info screen, temp occ, and temp not occ.
- one minute: when returning from setting clock/day.
- ten minutes: when returning from System Checkout.
- five minutes: when returning from all other modes.

Special Functions

Restore Factory Configuration (Run/Clear)

IMPORTANT

This operation erases current configuration and restores factory defaults for all configuration, parameters, setpoints and schedules. To regain the old configuration requires device reconfiguration.

1. Press both *Run Schedule* and *Clear Start Time*.
2. The display gives the option to revert to FAC CFG.
 - a. To restore the factory defaults, press up ▲ or down ▼ until the display indicates YES.
 - b. To cancel this option, ensure the display indicates NO.
3. Press *Run Schedule*.

Get Factory Schedule (Info/Clear)

Performing this operation reverts the schedules to the factory defaults:

1. Press both *Info* and *Clear Start Time*.
2. The display gives the option to revert to FAC SCH.
 - a. To restore the factory schedule, press up ▲ or down ▼ until the display indicates YES.
 - b. To cancel this option, ensure display indicates NO.
3. Press *Run Schedule*.

Test Mode (Occupied/Not Occupied/Schedule Day)



CAUTION

Possible Equipment Damage.
Equipment damage can result if compressor is cycled too quickly.

The minimum off time for compressors is bypassed during Test Mode. Equipment damage can occur if the compressor is cycled too quickly.

Use Test Mode to check the thermostat configurations and operation. To start the system test:

1. Press *Schedule Day*, *Occupied* and *Not Occupied* simultaneously.
2. The display gives the option to TEST.
 - a. To enter test mode, press up ▲ or down ▼ until the display indicates IN TEST.
 - b. To cancel this option, ensure display indicates NO TEST.
3. Press *Run Schedule*.

NOTES:

- To verify whether or not the system test is still active, repeat the above process.
- The system test times out after ten minutes with no key pressed.

Save User Schedule (Info/Copy)

Performing this operation saves the current schedule (including holidays) to memory, overwriting the old saved schedule:

1. Press both *Info* and *Copy*.
2. The display gives the option to revert to SAV SHD.
 - a. To save the current schedule, press up ▲ or down ▼ until the display indicates YES.
 - b. To cancel this option, ensure display indicates NO.
3. Press *Run Schedule*.

Get User Schedule (Info/Run)

Getting the user schedule restores the schedule (including holidays) from saved memory, overwriting the schedule currently in use:

1. Press both *Run Schedule* and *Info*.
2. The display gives the option to GET SHD.
 - a. To retrieve the saved schedule, press up ▲ or down ▼ until the display indicates YES.
 - b. To cancel this option, ensure display indicates NO.
3. Press *Run Schedule*.

TROUBLESHOOTING GUIDE (TABLE 4)

Table 4. Troubleshooting Information.

Symptom	Possible Cause	Action
Display will not come on.	Thermostat is not being powered.	Check that X terminal is connected to the system transformer. Check for 24 Vac between X and RH terminals. If missing 24 Vac: <ul style="list-style-type: none"> • Check if circuit breaker is tripped; if so, reset circuit breaker. • Check if system fuse is blown; if so, replace fuse. • Check if the HVAC equipment power switch is in the Off position; if so, set to the On position. • Check wiring between thermostat and HVAC equipment. Replace broken wires and tighten loose connections. If 24 Vac is present, proceed with troubleshooting.
Temperature display is incorrect.	Room temperature display has been recalibrated.	Use PDA configuration software to recalibrate as desired.
	Thermostat is configured for °F or °C display.	Press both <i>Run Schedule</i> and <i>Copy</i> , then reconfigure the display.
	Bad thermostat location.	Relocate the thermostat.
	Display shows three dashes and a degree sign (all systems shut down).	T7350 is set for remote sensing and sensor is missing or circuit is either open or shorted.

Table 4. Troubleshooting Information. (Continued)

Symptom	Possible Cause	Action
Temperature settings will not change. (Example: Cannot set heating higher or cooling lower.)	Upper or lower temperature limits were reached.	Check the temperature setpoints: <ul style="list-style-type: none"> • Heating limits are 40 to 90°F (7 to 31°C) • Cooling limits are 45 to 99°F (9 to 37°C)
	Occupied setpoint temperature range stops were configured.	Using a PDA, check setpoint stops. If necessary, reconfigure the stop(s).
	Keypad is locked. When a locked key is pressed, LOCKED appears momentarily on the LCD.	<ul style="list-style-type: none"> • Use PDA (Set, Display) to unlock keypad. • Press both <i>Run Schedule</i> and <i>Copy</i>, then change keypad lock level.
Room temperature is out of control.	Remote temperature sensing is not working.	Check all remote sensors.
Heat will not come on.	No power to the thermostat.	Check that X terminal is connected to the system transformer. Check for 24 Vac between X and RH terminals. If missing 24 Vac: <ul style="list-style-type: none"> • Check if circuit breaker is tripped; if so, reset circuit breaker. • Check if system fuse is blown; if so, replace fuse. • Check if the HVAC equipment power switch is in the Off position; if so, set to the On position. • Check wiring between thermostat and HVAC equipment. Replace broken wires and tighten loose connections. If 24 Vac is present, proceed with troubleshooting.
		Thermostat minimum off time is activated.
	System selection is set to Off or Cool.	Set system selection to Heat or Auto.
Cooling will not come on.	No power to the thermostat.	Check that X terminal is connected to the system transformer. Check for 24 Vac between X and RH terminals. If missing 24 Vac: <ul style="list-style-type: none"> • Check if circuit breaker is tripped; if so, reset circuit breaker. • Check if system fuse is blown; if so, replace fuse. • Check if the HVAC equipment power switch is in the Off position; if so, set to the On position. Check wiring between thermostat and HVAC equipment. Replace broken wires and tighten loose connections. If 24 Vac is present, proceed with troubleshooting.
		Thermostat minimum off time is activated.
	System selection is set to Off or Heat.	Set system selection to Cool or Auto.
System indicator (flame: heat, snowflake: cool) is displayed, but no warm or cool air is coming from the registers.	The call for heat or cool is not yet given.	Check if any stage indicators (dots next to the system indicator) are displayed. With no display of stage indicators, no call for cool/heat is yet given. For T7350M models <i>only</i> : Check the information screens. A MODHEAT or MODCOOL percentage of zero indicates a signal of 4 mA from the given terminal.
	Conventional heating equipment turns the fan on only after the furnace has warmed to a setpoint.	Wait one minute after seeing the on indicator and then check the registers.
	Heating or cooling equipment is not operating.	Verify operation of heating or cooling equipment in self-test.

WIRING DIAGRAMS (FIG. 7-14)

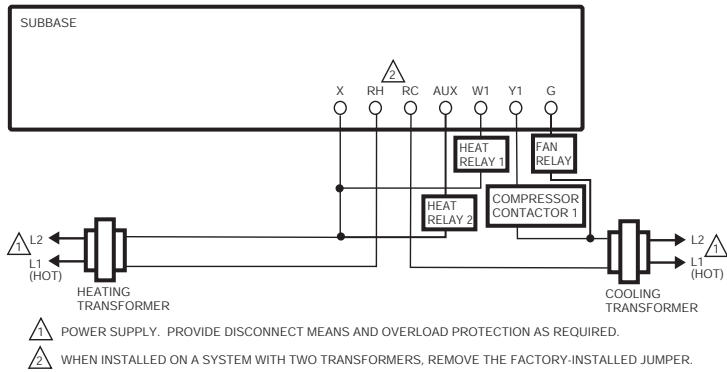

M19764A

Fig. 7. Typical hookup of T7350A in two-stage heat and one-stage cool conventional system with two transformers.

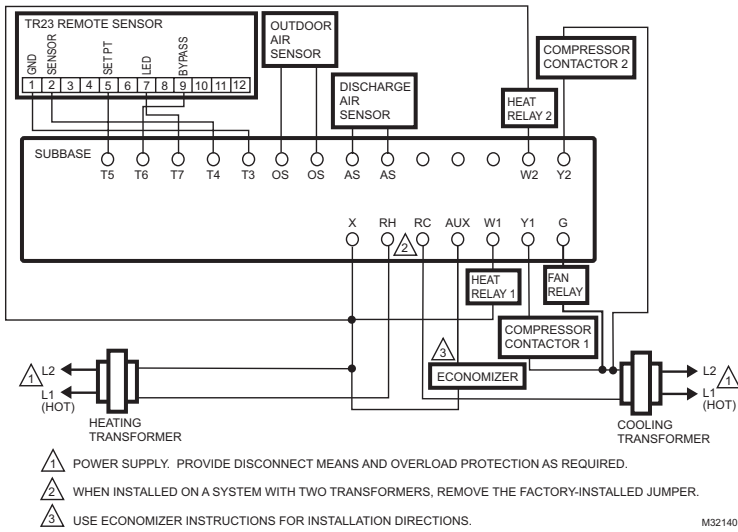

M32140

Fig. 8. Typical hookup of T7350B in two-stage heat and two-stage cool heat pump system with two transformers.

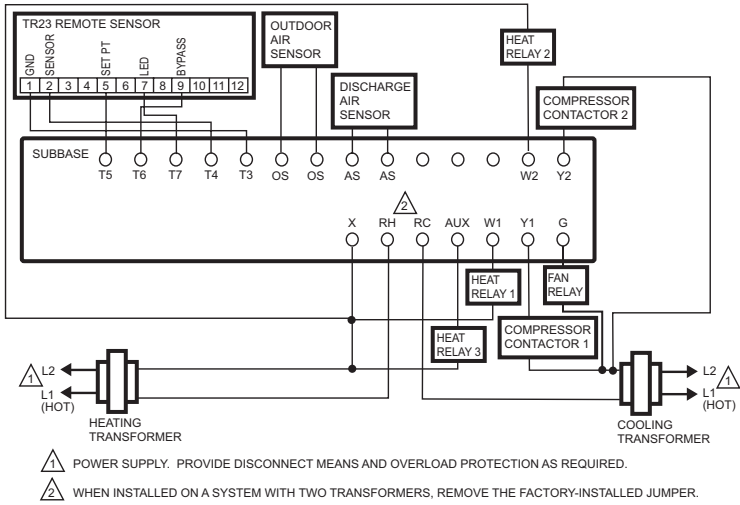

M32141

Fig. 9. Typical hookup of T7350B in three-stage heat and two-stage cool conventional system with two transformers.

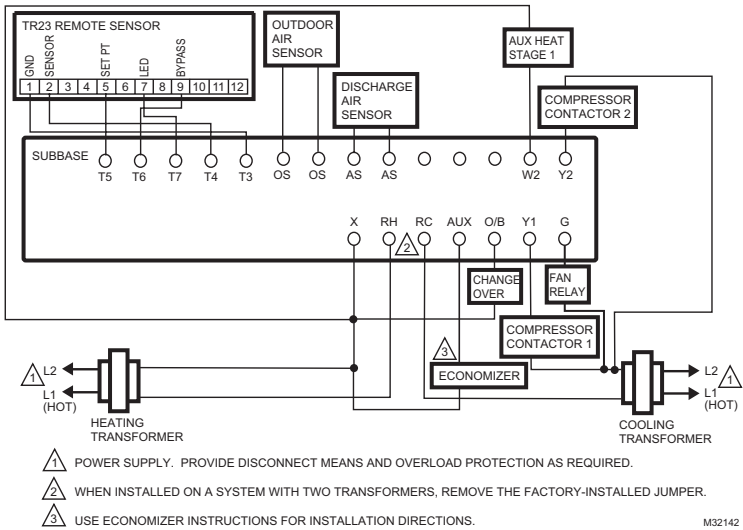

M32142

Fig. 10. Typical hookup of T7350B in three-stage heat and two-stage cool heat pump system with two transformers.

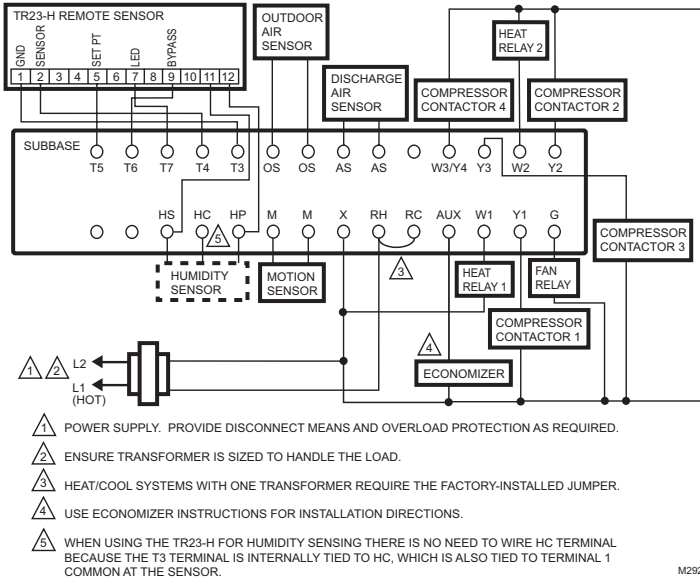

Fig. 11. Typical hookup of T7350D in two-stage heat and four-stage cool conventional system.

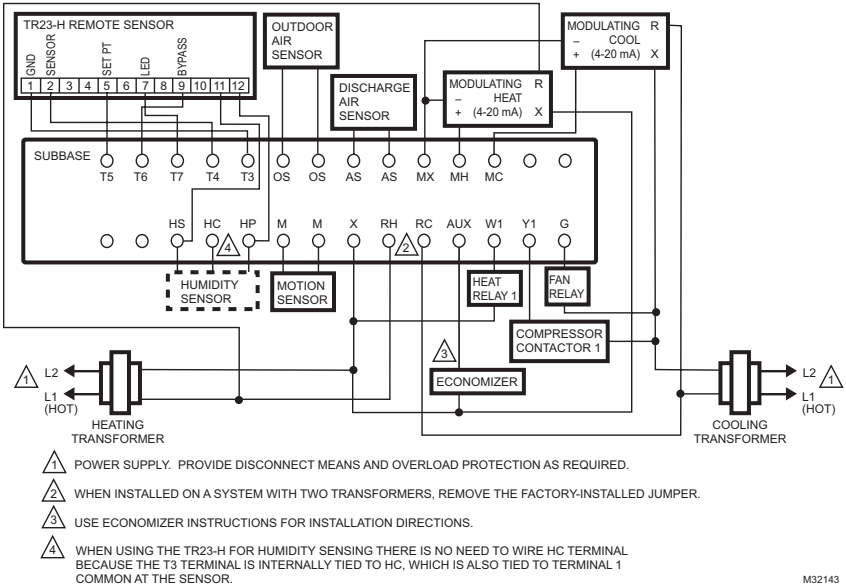
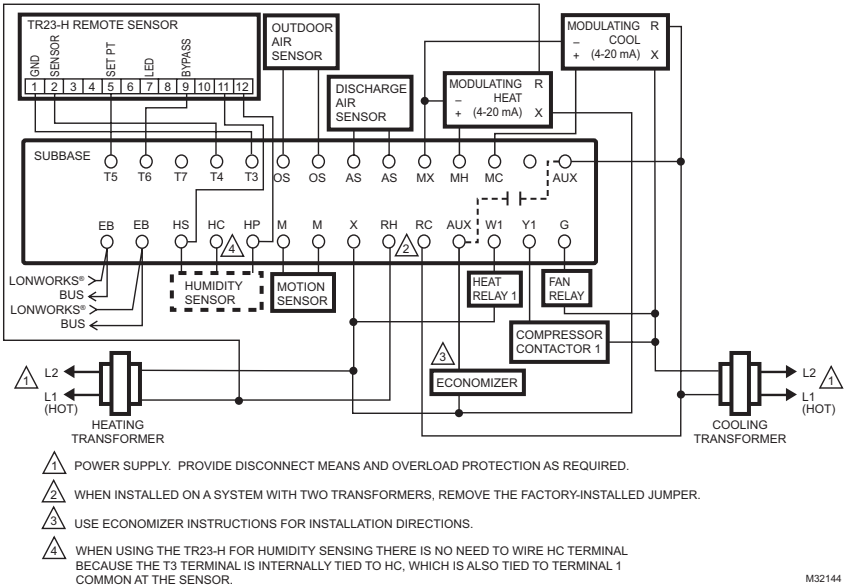
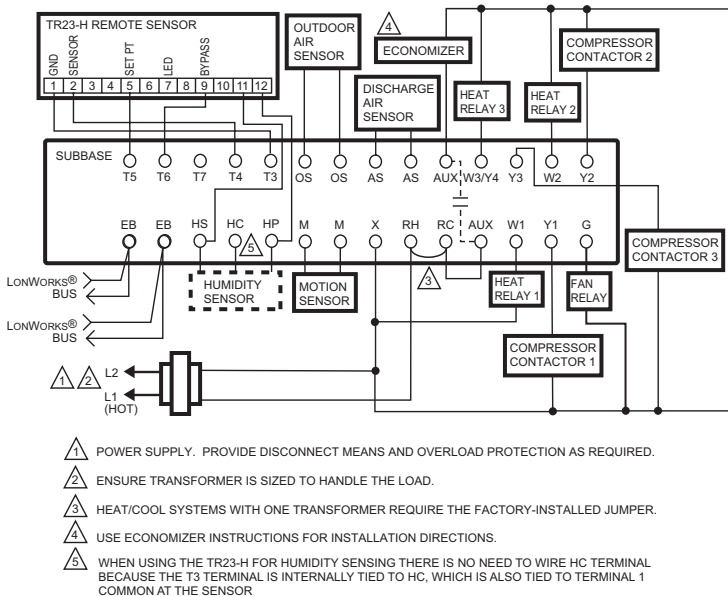

Fig. 12. Typical hookup of T7350M in two-stage heat (one modulating) and two-stage cool (one modulating) conventional system with two transformers.



M32144

Fig. 13. Typical hookup of T7350H1017 for system with two independent heat stages (one modulating), two independent cool stages (one modulating), and two transformers.



M32145

Fig. 14. Typical hookup of T7350H1009 in three-stage heat and three-stage cool conventional system with one transformer.

DEHUMIDIFICATION (T7350D,H,M)

There are five methods through which the T7350 can control for dehumidification. Three of them modify the control algorithm, thus providing limited dehumidification through cooling. The other two use the auxiliary output to control another device.

IMPORTANT

Configurable only with a PDA.

NOTE: The dehumidification high limit can be set within the range of 10 to 90 percent relative humidity.

Control Through Cooling

Configure using some combination of the following:

- Minimum On.
- Reheat.
- Reset.

NOTES:

- These methods operate only during cooling.
- Selecting both Reheat and Reset options can cause frequent setpoint adjustments. This selection is not recommended.

Min. ON Time

Dehumidifies by increasing the compressor minimum on time (normally 3 minutes) by a programmable amount. This is useful with oversized systems in that it forces the coils to cool to a point where dehumidification can occur.

NOTES:

- Can force wider temperature swings by cooling when setpoint control does not require it.
- The minimum on time can be set within the range of 5 to 15 minutes.
- Hysteresis and a minimum timer are used to ensure this behavior does not change with every equipment cycle.

Reheat

Dehumidifies by operating cooling during typical off time. The T7350 maintains the proper setpoint by running the heat at the same time.

IMPORTANT

At times during Reheat dehumidification, the T7350 operates heating and the cooling simultaneously. This is normal.

NOTES:

- The heat stage never energizes during Reheat if more than one cool stage is on.
- Reheat mode cannot occur during heating.
- The T7350M does not support the Reheat method.

Automation and Control Solutions

Honeywell International Inc.
1985 Douglas Drive North
Golden Valley, MN 55422

Honeywell Limited-Honeywell Limitée
35 Dynamic Drive
Toronto, Ontario M1V 4Z9
customer.honeywell.com

Reset Temp SetPt

The room temperature setpoint resets to a specified number of degrees below the actual setpoint when room relative humidity (RH) rises above humidity high limit setpoint.

Though this may not technically reduce relative humidity in the room, it reduces the dew point to provide the customer with a sense of comfort due to a lower temperature setting in the room.

As long as RH stays above humidity high limit setpoint, this setpoint is maintained.

NOTE: Hysteresis and a minimum timer prevent the setpoint from short interval alternation (between standard and reset setpoints).

Options Utilizing Auxiliary Output

There are two dehumidification options that utilize the auxiliary output. They are:

- Simple Dehumidification.
- Hot Gas Bypass Dehumidification.

Simple Dehumid(ification)

The auxiliary output:

- Energizes when RH rises above humidity high limit.
- De-energizes when RH drops below humidity high limit.

NOTES:

- Hysteresis and a minimum timer prevent short cycling of this output.
- Unlike Dehumid Hot Gas BP the relay remains energized during calls for multiple cooling stages.

Dehumid Hot Gas BP

The auxiliary output operates as shown in Table 5.

Table 5. Hot Gas Bypass Dehumidification Logic.

Humidity	Cooling Stages Active	Auxiliary Output
High	more than one	De-energized
High	one or less	Energized
Low	more than one	De-energized
Low	one or less	De-energized

Auxiliary output during call for multiple cooling stages for two reasons:

1. This method assumes that the cooling provides dehumidification.
2. Multiple cooling stages probably provide necessary dehumidification.

NOTE: Hysteresis and a minimum timer prevent short cycling of this output.

Honeywell