



Features & Options

- Flathead Screwdriver for Terminal Block screws
- 1/16" Allen Wrench for Cover Locking Screws
- Works on Delta, PreCon, Powers and all BAPI-Stat Room Unit Enclosures



6.75" model (top) and 6" model (bottom)

BAPI Screwdriver & Allen Wrench Combinations are especially useful for installing BAPI room units. The flathead screwdriver can be used to turn the screws on the circuit board terminal block while the 1/16" Allen wrench is used for the locking screws on the removable cover. One 6" screwdriver (BA/116) is included with every 25 room units ordered. This model is not designed for prolonged use. The 6.75" model (BA/116W) is designed for prolonged use.

Ordering Information

<u>Part Number</u>	<u>Description</u>	<u>List Price</u>
BA/116W.....	BAPI 6.75" Screwdriver & Allen Wrench Combination	\$20
BA/116.....	BAPI 6" Screwdriver & Allen Wrench Combination	\$5

Gray shaded items follow the Buy and Resale Multiplier.

Submittal datasheets without List Prices are available on our website at www.bapihvac.com

Allen Wrench Locking Screw Locations for BAPI Room Units

The figures below show the location of the locking screws on 5 of BAPI's room unit enclosures. The BAPI Screwdriver can be used with all of them. Simply snap the cover in place and turn the locking screws counterclockwise with the Allen wrench, backing them out to lock the cover in place.

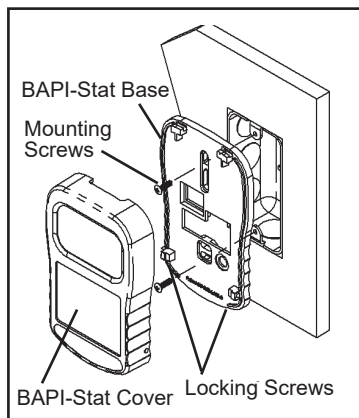

BAPI-Stat Style Enclosure

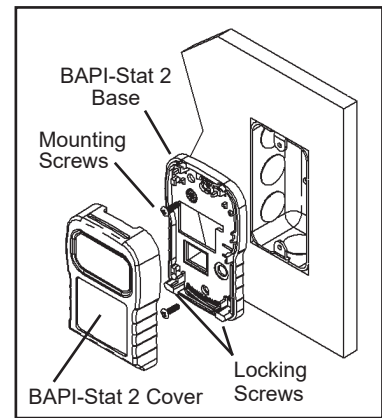

BAPI-Stat 2 Style Enclosure

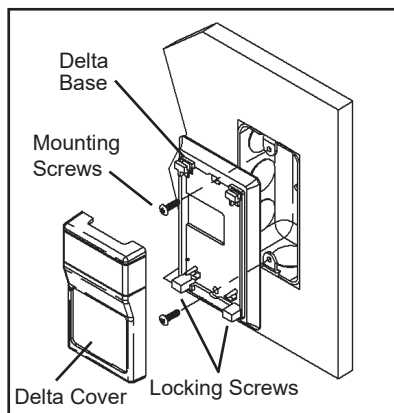

Delta Style Enclosure

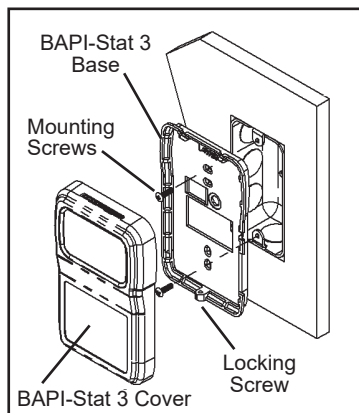

BAPI-Stat 3 Style Enclosure

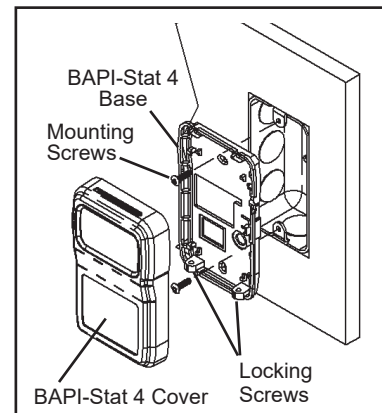

BAPI-Stat 4 Style Enclosure

