

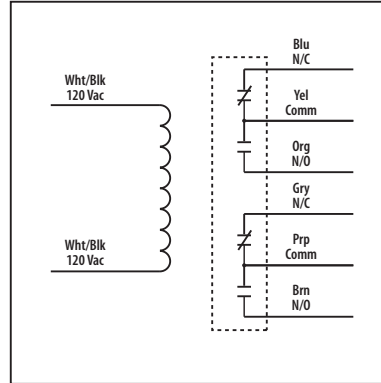

20 Amp Power Control Relay

RIB01P

Enclosed Relay 20 Amp DPDT with 120 Vac Coil



■ SPECIFICATIONS

Relays & Contact Type: One (1) DPDT Continuous Duty Coil
Expected Relay Life: 10 million cycles minimum mechanical
Operating Temperature: -30 to 140° F
Operate Time: 18ms
Relay Status: LED On = Activated
Dimensions: 4.00" x 4.00" x 1.80" with .50" NPT Nipple
Wires: 16", 600V Rated
Approvals: UL Listed, UL916, UL864, C-UL
 California State Fire Marshal, CE, RoHS
Housing Rating: Plenum, NEMA 1
Gold Flash: Yes
Override Switch: No

Contact Ratings:
 20 Amp Resistive @ 300 Vac
 20 Amp Resistive @ 28 Vdc
 20 Amp Ballast @ 277-480 Vac
 15 Amp Resistive @ 600 Vac
 770 VA Pilot Duty @ 120 Vac
 1158 VA Pilot Duty @ 240 Vac
 1109 VA Pilot Duty @ 277 Vac
 1640 VA Pilot Duty @ 480 Vac
 Heavy Pilot Duty @ 600 Vac
 3 HP @ 480-600 Vac
 2 HP @ 240-277 Vac
 1 HP @ 120 Vac

Coil Current:
 105 mA @ 120 Vac

Coil Voltage Input:
 120 Vac ; 50-60 Hz
 Drop Out = 35 Vac
 Pull In = 85 Vac

Notes