

# Technical Documentation Multi-Function Technology (MFT) for Damper and Control Valve Applications

Effective May 2010



**MFT**  
MULTI-FUNCTION TECHNOLOGY®

# Multi-Function Technology®

## Your swiss army knife for HVAC.



We set standards.  
[www.belimo.com](http://www.belimo.com)

Features and benefits only Belimo's MFT can provide.

Multi-Function Technology, only from Belimo, allows you to create custom solutions for individual applications, using the same programmable actuator. Whether you need a particular control or feedback signal, or need to change running speeds, MFT is the answer. It comes standard as a 2 to 10 VDC proportional control but can be reprogrammed on-site. You can modify voltage control, time proportional control, floating point, on/off and feedback signals too. In addition, MFT makes it easy to set parameters for running time, mechanical working range, address, status and diagnostics. Think of it as your all-in-one, swiss army knife for HVAC.



Feature	Benefit
Configurable control and feedback signal type	Reduced number of actuators required in stock
Variable runtime	Flexibility to tune to each application
Flexible angle of rotation setting	Customized to fit application - to drive actuator less than 100% open/closed
Scalable operating range	Optimized control resolution for every operating range
Min, Mid, Max override function	Additional system control beyond modulation
Stored alarm information	Ease troubleshooting
Data logging capability	Gather system data for optimization or diagnostics

# MULTI-FUNCTION TECHNOLOGY

Belimo damper actuators and control valves with Multi-Function Technology (MFT) are an excellent way to standardize your product line while reducing the number of different actuators needed. Multi-

## MFT

**MULTI-FUNCTION TECHNOLOGY®**

Function Technology offers a wide variety of programmable control inputs and feedback signals. Parameters can be set

for voltage control (VDC), time proportional control (PWM), floating point, on-off, feedback signal, or torque output. Parameters can be changed on-site to optimize/enable application. You can also set, modify or read position, running time, mechanical working range, address, status, and diagnostics.

MFT offers tailor made solutions allowing you to adapt the actuator of valve to your system for replacement and to improve system functionality.

## BELIMO PC-TOOL

Laptop access anywhere.

Universal Access to all MFT actuators.

The PC-Tool is a universal software application for setting, commissioning, monitoring and evaluating communications with Belimo actuators. Actuators are normally delivered with the basic settings. They can be individually programmed using the PC-Tool and precisely adjusted to the requirements of the system. Service related diagnostics for the actuators are extremely easy with the PC-Tool. Setpoints can be specified and actual values monitored The trend recording function can output the information in a graphical format for system documentation.

# Table of Contents

<b>MULTI-FUNCTION TECHNOLOGY</b>	
Nomenclature . . . . .	2
MFT Overview . . . . .	3
Spring Return Actuator Product Range Multi-Function Technology . . . . .	4
Non-Spring Return Actuator Product Range Multi-Function Technology . . . . .	5
Pre-Set MFT Configurations . . . . .	6
Pulse Width Modulation Control . . . . .	7
Flow Point Control . . . . .	8
On/Off Control . . . . .	9
MFT Operation . . . . .	10
MFT Specifications/Descriptions . . . . .	14
Wiring . . . . .	16
Programming Codes . . . . .	20
<b>PC-TOOL ACCESSORIES</b>	
<b>Software</b>	
MFT-P US . . . . .	35
<b>Interfaces</b>	
ZIP-USB-MP US . . . . .	36
ZIP-RS232 US . . . . .	37
MFT Cables . . . . .	38
<b>USER MANUALS</b>	
<b>PC-Tool User Manual . . . . .</b>	<b>1-A</b>
Introduction . . . . .	1-1
Configuration . . . . .	1-29
PC-Tool Options . . . . .	1-40
<b>Damper and Valve Actuators User Manual . . . . .</b>	<b>2-A</b>
Introduction . . . . .	2-1
Service . . . . .	2-2
Configuration . . . . .	2-7
Controller Simulation . . . . .	2-14
PC-Tool Options . . . . .	2-18
<b>NV/NVF Series Actuators User Manual . . . . .</b>	<b>3-A</b>
Introduction . . . . .	3-3
Service . . . . .	3-4
Configuration . . . . .	3-7
Controller Simulation . . . . .	3-11
PC-Tool Options . . . . .	3-15
<b>ePIV Series User Manual . . . . .</b>	<b>4-A</b>
Introduction . . . . .	4-3
Service . . . . .	4-4
Configuration . . . . .	4-9
Controller Simulation . . . . .	4-12
PC-Tool Options . . . . .	4-16
<b>SY Series User Manual . . . . .</b>	<b>5-A</b>
Introduction . . . . .	5-3
Service . . . . .	5-4
Configuration . . . . .	5-7
Controller Simulation . . . . .	5-11
PC-Tool Options . . . . .	5-15

<b>B2</b>	<b>50</b>	<b>AR</b>	<b>X</b>	<b>24</b>	<b>-MFT</b>	
<p><b>Valve</b>                  B2 = 2-Way                  B3 = 3-Way                  B6 = 2-Way Flanged</p>	<p><b>Valve Size</b>                  07-80 = 1/2" - 3"</p>	<p><b>Torque Rating</b>  <b>Non-Spring Return</b>                  GM = 360 in-lb                  AM = 180 in-lb                  NM = 90 in-lb                  LM = 45 in-lb                  LU = 27 in-lb                  AH = 220 lbf                  LH = 100 lbf  <b>New Generation Spring Return</b>                  AF = 180 in-lb                  NF = 90 in-lb  <b>Original Spring Return</b>                  AF = 133 in-lb                  NF = 60 in-lb                  LF = 35 in-lb                  TF = 18 in-lb</p>	<p><b>Version</b>                  X* = Customized Cable                  10 ft (3m)                  16 ft (5m)                  Run Time Variable</p>	<p><b>Power Supply</b>                  24 = 24 VAC/DC                  120 = 120 to 230 VAC</p>	<p><b>Control</b>                  -MFT = Multi-Function Technology                  -MFT95** = 0-135 Ω</p>	<p>-S = Built-in Auxiliary Switch</p>

\* Only available on New Generation Spring Return and Non-Spring  
 \*\* Not Available on NF, LF and TF

**Ordering Example**

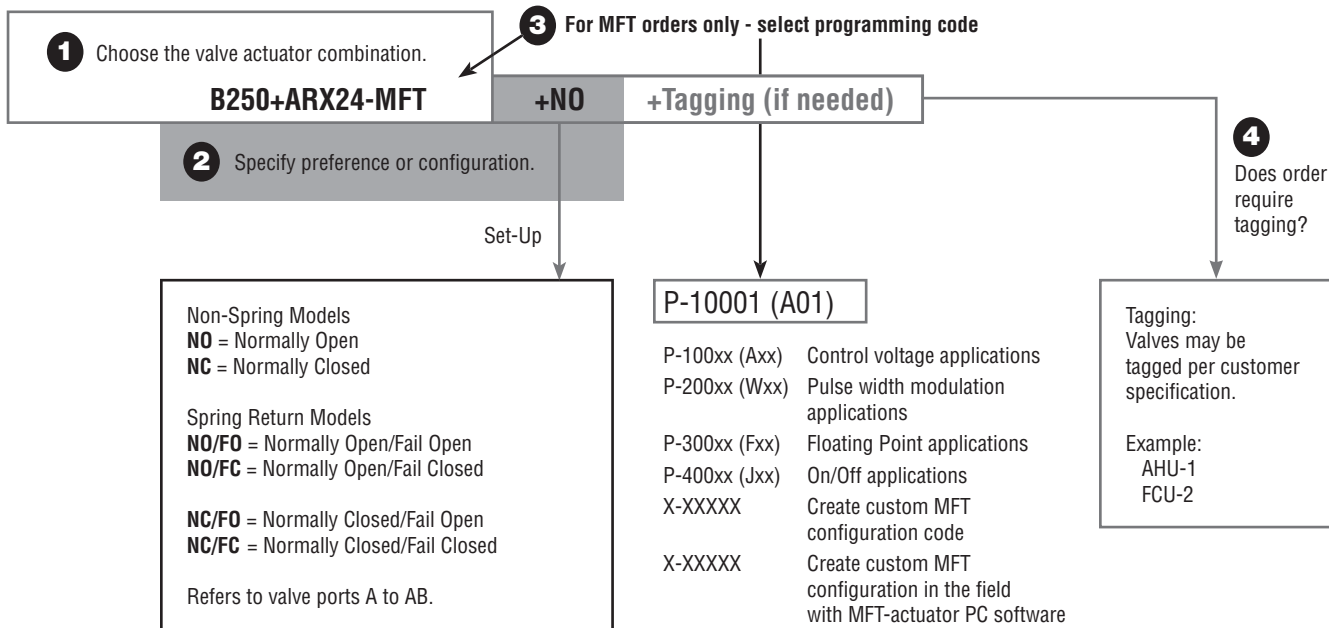

IM40035 - 05/10 - Subject to change. © Belimo Aircontrols (USA), Inc.

	Control	Parameter Variables	Description
<b>Input</b>	<b>VDC</b>	<ul style="list-style-type: none"> <li>• Start: 0.5 to 30 VDC</li> <li>• Stop: 2.5 to 32 VDC</li> </ul> (Minimum 2 VDC between start and stop required)	P-100...(A...) configuration types are used for VDC control applications. Pre-set configurations are listed which offer solutions for standard control applications. Additional pre-set configurations are list which offer solutions for non-standard control application for: <ul style="list-style-type: none"> <li>• Sequencing Actuators</li> <li>• Adjustable Start and Stop Points</li> <li>• Combination for Master Slave</li> </ul>
	<b>Pulse Width Modulation (PWM)</b>	PWM Range <ul style="list-style-type: none"> <li>• 0.02 to 50 sec. range minimum interval</li> <li>• 20 [ms] between pulses</li> <li>• Minimum cycle duration 520 [ms]</li> </ul>	P-200...(W...) configuration types are used for pulse width modulation control outputs with four standard ranges. There must be at least one second between the min pulses allowed (0.02 sec.) and the max pulse allowed (50 sec.). (eg: 0.02 to 1.02 sec.)
	<b>Floating Point</b>		P-300...(F...) configuration types are used for floating point control outputs. In this application MFT actuators offer constant running time and standard feedback options. A 1N4004 diode is required for original spring return actuators. The actuator is designed to recognize the rectified voltage as an opposite control signal request.
	<b>On/Off</b>		P-400...(J...) configuration types are used for on/off control outputs. The configuration allows for service replacement of on/off actuators when a true on/off actuator is not available. In addition the MFT actuator offers additional functionality in the on/off mode, such as configuration P-40003 (J03) with minimum position and 2 to 10 VDC feedback.
<b>Feedback</b>	<b>Position Feedback</b>	Position Feedback Range <ul style="list-style-type: none"> <li>• Start: 0.5 to 8 VDC Selectable</li> <li>• Stop: 2 to 10 VDC Selectable</li> </ul>	The default-operating mode of the U5 output is 2 to 10 VDC for position feedback.
<b>Sensitivity</b>	<b>Control Sensitivity</b>	Normal (Default)	MFT actuators are designed with a unique non-symmetrical dead band. The actuator follows an increasing control signal with a 80 mV resolution. If the signal changes in the opposite direction, the actuator will no respond until the control signal changes by 200 mV. This allows the actuator to track even the slightest deviation very accurately, yet allowing the actuator to "wait" for a much larger change in control signal. For quick actuators the values are half.
		Reduced	Upon detecting an un-stable control loop, the "reduced" setting can be manually selected via the PC software. This will reduce the sensitivity of the actuator by 50%.  Meaning, control accuracy will now be 160 mV for signal changes in the same direction. And a 400 mV signal change in the opposite direction is needed for the actuator to change direction. Once driving in the opposite direction the actuator will respond in 160 mV increments.  Upon improving the control loop stability you can return the actuator to the "Normal" mode.

# Spring Return Actuator Product Range

## Multi-Function Technology



	Cable Options	Running Time		Power Supply	Power Consumption		Control Input			Control Input MFT						Auxiliary Switches			NEMA 4
		10 ft (3m) cable / 16 ft (5m) cable	Motor Drive, (Default) Fully programmable by Belimo or in field)		Spring Return	24 VAC +/- 20%, VDC +/- 10%, 50/60 HZ	VA Rating, Transformer Sizing	Wattage Running (Holding)	2-10 VDC (Default) 4-20 mA* (w/500 Ω Resistor)	6 - 9 VDC, 20 VDC Output Voltage	Honeywell Series 90, 0-135 Ω	On/Off	Floating Point	Start and Span adj., Start 0.5 to 30 VDC, Span 2.5 to 32 VDC	PWM adj., 0.02 to 50.0 Seconds	2-10 VDC (Default)	VDC Variable, Start 0 to 8, Span 2 to 10 VDC	1 SPDT, 3 A (0.5 A inductive) @ 250V	
<b>New Generation AFX Series</b> 180 in-lb [20 Nm] Approx. 45 sq. ft.*	AFX24-MFT†	●	70...220 (150)	<20♦	●	10	7.5 (3.0)	●		●	●	●	●	●	●				●
	AFX24-MFT-S†	●	70...220 (150)	<20♦	●	10	7.5 (3.0)	●		●	●	●	●	●	●		●		●
	AFX24-MFT95†		70...220 (150)	<20♦	●	10	7.5 (3.0)	●	●					●	●				●
<b>Original AF Series</b> 133 in-lb [15 Nm] Approx. 33 sq. ft.*	AF24-MFT US†		75...300 (150)	<20	●	10	6.0 (2.5)	●		●	●	●	●	●	●				
	AF24-MFT-S US†		75...300 (150)	<20	●	10	6.0 (2.5)	●		●	●	●	●	●	●			●	
	AF24-MFT95 US†		75...300 (150)	<20	●	10	6.0 (2.5)	●	●					●	●				
<b>New Generation NFX Series</b> 90 in-lb [10 Nm] Approx. 22 sq. ft.*	NFX24-MFT	●	40...220 (150)	<20♦	●	9	6.5 (3.0)	●		●	●	●	●	●	●				●
	NFX24-MFT-S	●	40...220 (150)	<20♦	●	9	6.5 (3.0)	●		●	●	●	●	●	●		●		●
<b>Original NF Series</b> 60 in-lb [7 Nm] Approx. 15 sq. ft.*	NF24-MFT US		75...300 (150)	<60♦	●	6	3.0 (1.8)	●		●	●	●	●	●	●				
<b>LF Series</b> 35 in-lb [4 Nm] Approx. 8 sq. ft.	LF24-MFT US		75...300 (150)	<25♦	●	5	2.5 (1.0)	●		●	●	●	●	●	●				
	LF24-MFT-S US		75...300 (150)	<25♦	●	5	2.5 (1.0)	●		●	●	●	●	●	●	●			
	LF24-MFT-20 US		150	<25♦	●	6	3.5 (1.5)	●	●	●	●	●	●	●	●				
	LF24-MFT-S-20 US		150	<25♦	●	6	3.5 (1.5)	●	●	●	●	●	●	●	●	●			
<b>TF Series</b> 18 in-lb [2 Nm] Approx. 4.5 sq. ft.*	TF24-MFT US		75...300 (150)	<25♦	●	4	2.0 (1.0)	●		●	●	●	●	●	●				

♦ <60 seconds @ -22°F [-30°C].

† Dual mounting on a single shaft-MFT wired master slave. Please refer to page XX or call Belimo customer service for details.

\* Parallel blade without edge seals and 1000 FPM face velocity.

NOTE: Some spring and non-spring damper actuators are also used for water applications. A linkage connects the actuators to the valve. Some of the valves, such as the PICCV use a running time of 100 seconds. Some actuators end with an X1 such as AMX24-MFTX1.

IM40035 - 05/10 - Subject to change. © Belimo Aircontrols (USA), Inc.



	Custom Options	Running Time	Power Supply		Power Consumption		Control Input		Control Input MFT			Position Feedback		Auxiliary Switches	NEMA 4X		
			10 ft (3m) cable / 16 ft (5m) cable	Terminal strip NEMA 1/IP20 / 2/IP54	Motor Drive Range, (Default) ...-MFT Fully Programmable	24 VAC +/- 20%, VDC +/- 10%	100 to 240 VAC	VA Rating	Wattage Running (Holding)	2-10 VDC (Default) 4-20 mA (w/500 Ω Resistor)	Honeywell Series 90, 0-135 Ω	On/Off	Floating Point	Start and Span adj., Start 0.5 to 30 VDC, Span 2.5 to 32 VDC	PWM adj., 0.02 to 50.0 Seconds	2-10 VDC (Default)	VDC Variable, Start 0 to 8, Span 2 to 10 VDC
<b>GMX Series</b> 360 in-lb [40 Nm] Approx. 90 sq. ft.**	GMX24-MFT†	●	75-300 (150)	●	7	4.0 (1.5)	●	●	●	●	●	●	●	●	●	●	
	GMX24-MFT95†	●	100-300 (150)	●	7	4.0 (1.5)	●	●	●	●	●	●	●	●	●	●	
<b>AMX Series</b> 180 in-lb [20 Nm] Approx. 45 sq. ft.**	AMX24-MFT	●	90-300 (150)	●	6	3.5 (1.3)	●	●	●	●	●	●	●	●	●	●	●
	AMCX24-MFT	●	35-120 (35)	●	6	3.5 (1.3)	●	●	●	●	●	●	●	●	●	●	
	AMX24-MFT95	●	90-150 (150)	●	6	3.5 (1.3)	●	●	●	●	●	●	●	●	●	●	
<b>AMQ Series</b> 140 in-lb [16Nm]	AMQX24-MFT	●	7-15 (7)	●	18	12 (1.5)	●	●	●	●	●	●	●	●	●	●	
<b>NMX Series</b> 70 in-lb [8 Nm] Approx. 22 sq. ft.**	NMX24-MFT	●	45-150 (150)	●	6	3.5 (1.3)	●	●	●	●	●	●	●	●	●	●	●
	NMX24-MFT95	●	45-150 (150)	●	6	3.5 (1.3)	●	●	●	●	●	●	●	●	●	●	
	NMCX24-MFT	●	20-75 (20)	●	5	3.0 (0.6)	●	●	●	●	●	●	●	●	●	●	
<b>NMQ Series</b> 70 in-lb [8Nm]	NMQX24-MFT	●	4-20 (4)	●	18	12 (1.5)	●	●	●	●	●	●	●	●	●	●	
<b>LMX Series</b> 35 in-lb [4 Nm] Approx. 11 sq. ft.**	LMX24-MFT	●	35-200 (150)	●	5	2.5 (1.2)	●	●	●	●	●	●	●	●	●	●	
	LMX24-MFT95	●	35-150 (150)	●	5	2.5 (1.2)	●	●	●	●	●	●	●	●	●	●	
<b>LMQ Series</b> 35 in-lb [4Nm]	LMQX24-MFT	●	2.5-10 (2.5)	●	18	12 (1.5)	●	●	●	●	●	●	●	●	●	●	
<b>AHX Series</b> 101 lbf [450 N Force] 4" or 8" stroke	AHX24-MFT*	●	150*	●	6	3.5 (1.3)	●	●	●	●	●	●	●	●	●	●	
<b>AHQ Series</b> 44 lbf [200 N Force]	AHQX24-MFT-100	●	7-30 (7)*	●	18	12 (1.5)	●	●	●	●	●	●	●	●	●	●	
<b>LHX Series</b> 34 lbf [150 N Force] 4" or 8" stroke	LHX24-MFT*	●	75-150 (150)*	●	5	2.5 (1.2)	●	●	●	●	●	●	●	●	●	●	
<b>LHQ Series</b> 22 lbf [100 N Force]	LHQX24-MFT-100	●	3.5-15 (3.5)*	●	18	12 (1.5)	●	●	●	●	●	●	●	●	●	●	
<b>LUX Series</b> 27 in-lb [3 Nm]	LUX24-MFT	●	75-150 (150)	●	5	2.5 (1.2)	●	●	●	●	●	●	●	●	●	●	

\* The LH and AH linear series actuators come in three different stroke lengths [4, 8 or 12 in]. The part number is followed by -100, -200, -300 respectively. The default running time is 150 seconds per 4 inches [100 mm]. Running time is adjustable depending on model:  
 LH Series: 70-270, 140-540, 200-810, on the -100, -200, -300 models respectively.  
 AH Series: 150-600, 300-1200, 450-1800, on the -100, -200, -300 models respectively.

LHQ and AHQ available in 4 inch version only.

† Dual mounting on a single shaft is possible for higher torque (-3 and -SR wired in parallel), (-MFT wired Master-Slave). Please call Belimo customer service for details.

\*\* Parallel blade without edge seals and 1000 FPM face velocity.

M40035 - 05/10 - Subject to change. © Belimo Aircontrols (USA), Inc.

# Pre-Set MFT Configurations

## DC Voltage Control



### Spring Return Actuators



AFX24-MFT(-S)	180 in-lb
AF24-MFT(-S) US	133 in-lb
NFX24-MFT(-S)	90 in-lb
NF24-MFT US	60 in-lb
LF24-MFT(-S) US	35 in-lb
LF24-MFT(-S)-20 US	35 in-lb
TF24-MFT US	18 in-lb

### Non-Spring Return Actuators



GMX24-MFT	360 in-lb
AMX24-MFT	180 in-lb
NMX24-MFT	90 in-lb
LMX24-MFT	45 in-lb
AMQX24-MFT	140 in-lb
NMQX24-MFT	70 in-lb
LMQX24-MFT	35 in-lb
AHX24-MFT	101 lbf
AHQX24-MFT-100	44 lbf
LHX24-MFT	34 lbf
LHQX24-MFT-100	22 lbf
LUX24-MFT	27 in-lb

### Application

How the MFT actuator performs is determined by the configuration (P-10001, A01). The old generation actuators used a P-code (P-10001). The new generation actuators use a shorter 3 digit code. This shorter code is displayed on the reorder number.

P-1000... configuration types are used for control voltage applications.

Additional pre-set configurations are listed which offer solutions for non-standard control application for:

- Adjustable Start and Stop points
- Sequencing actuators
- Combination for master slave (see page 19.)



### Wiring Diagram

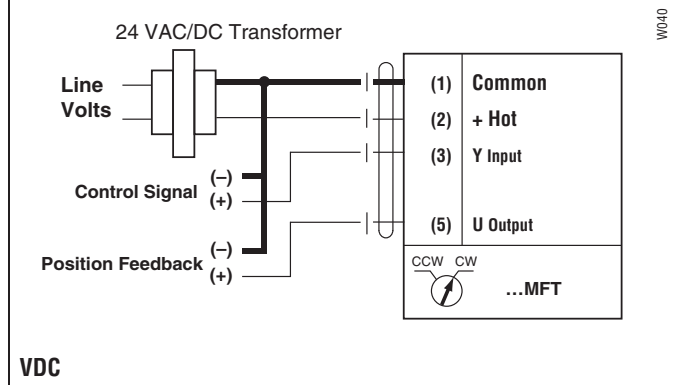

### Select Configuration

Configuration	Code	Input Range	Position Feedback	Running Time	Torque %	Adaptation
P-10001*	A01	2.0 to 10.0 VDC	2.0 to 10.0 VDC	150	100	MANUAL
P-10002	A02	0.5 to 10.0 VDC	0.5 to 10.0 VDC	150	100	MANUAL
P-10003	A03	2.0 to 10.0 VDC	0.5 to 5.0 VDC	150	100	MANUAL
P-10004	A04	4.0 to 7.0 VDC	2.0 to 10.0 VDC	150	100	MANUAL
P-10005	A05	6.0 to 9.0 VDC	2.0 to 10.0 VDC	150	100	MANUAL
P-10006	A06	10.5 to 13.5 VDC	2.0 to 10.0 VDC	150	100	MANUAL
P-10007	A07	0.5 to 5.0 VDC	2.0 to 10.0 VDC	150	100	MANUAL
P-10008	A08	0.5 to 5.0 VDC	0.5 to 10.0 VDC	150	100	MANUAL
P-10009	A09	5.0 to 10.0 VDC	2.0 to 10.0 VDC	150	100	MANUAL
P-10010	A10	5.0 to 10.0 VDC	0.5 to 10.0 VDC	150	100	MANUAL
P-10013	A13	0.5 to 10.0 VDC	2.0 to 10.0 VDC	150	100	MANUAL
P-10015	A15	2.0 to 5.0 VDC	2.0 to 10.0 VDC	150	100	MANUAL
P-10016	A16	2.0 to 6.0 VDC	2.0 to 10.0 VDC	150	100	MANUAL
P-10017	A17	6.0 to 10.0 VDC	2.0 to 10.0 VDC	150	100	MANUAL
P-10018	A18	14.0 to 17.0 VDC	2.0 to 10.0 VDC	150	100	MANUAL
P-10020	A20	9.0 to 12.0 VDC	2.0 to 10.0 VDC	150	100	MANUAL
P-10031	A31	0.5 to 4.0 VDC	2.0 to 10.0 VDC	150	100	MANUAL
P-10063	A63	0.5 to 4.5 VDC	0.5 to 4.5 VDC	150	100	MANUAL
P-10064	A64	5.5 to 10.0 VDC	5.5 to 10.0 VDC	150	100	MANUAL
P-10091	A91	2.0 to 10.0 VDC	2.0 to 10.0 VDC	95	100**	MANUAL

\* P-10001 (A01) is the default configuration code.

\*\* Reduced torque in Spring Return (see page 19)



#### Spring Return Actuators



AFX24-MFT(-S)	180 in-lb
AF24-MFT(-S) US	133 in-lb
NFX24-MFT(-S)	90 in-lb
NF24-MFT US	60 in-lb
LF24-MFT(-S) US	35 in-lb
LF24-MFT(-S)-20 US	35 in-lb
TF24-MFT US	18 in-lb

#### Non-Spring Return Actuators



GMX24-MFT	360 in-lb
AMX24-MFT	180 in-lb
NMX24-MFT	90 in-lb
LMX24-MFT	45 in-lb
AH24-MFT	101 lbf
LH24-MFT	44 lbf
LUX24-MFT	27 in-lb

#### Application

How the MFT actuator performs is determined by the configuration (P-10001, A01). The old generation actuators used a P-code (P-10001). The new generation actuators use a shorter 3 digit code. This shorter code is displayed on the reorder number.

P-2000... configuration types are used for Pulse Width Modulation control outputs. Most D.D.C. controllers have digital outputs which incorporate a default PWM range.

This enables a D.O. to be used as a proportional output when needed. Simply select the appropriate configuration code according to your application.

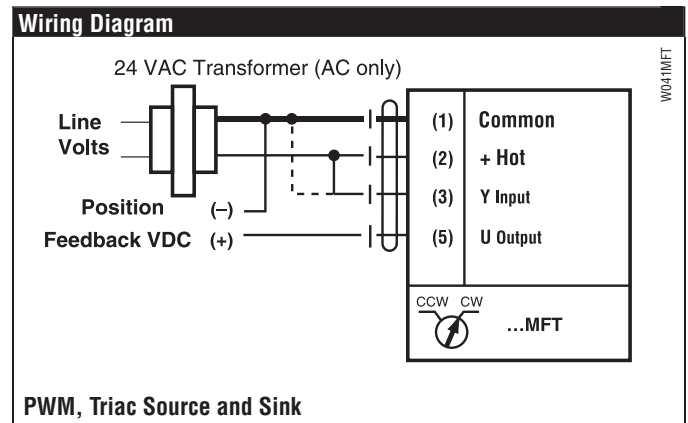

M40035 - 05/10 - Subject to change. © Belimo Aircontrols (USA), Inc.

#### Select Configuration

	Configuration	Code	Input Range	Position Feedback	Running Time	Torque %	Adaptation
<b>Pulse Width Modulation</b>	P-20001	W01	0.59 to 2.93 sec	2.0 to 10.0 VDC	150	100	MANUAL
	P-20002	W02	0.02 to 5.00 sec	2.0 to 10.0 VDC	150	100	MANUAL
	P-20003	W03	0.10 to 25.50 sec	2.0 to 10.0 VDC	150	100	MANUAL
	P-20004	W04	0.10 to 25.60 sec	2.0 to 10.0 VDC	150	100	MANUAL
	P-20005	W05	0.10 to 5.20 sec	0.5 to 5.0 VDC	150	100	MANUAL
	P-20012	W12	0.50 to 25.50 sec	0.5 to 10.0 VDC	150	100	MANUAL
	P-20013	W13	0.50 to 2.93 sec	0.5 to 5.0 VDC	150	100	MANUAL
	P-20014	W14	0.10 to 10.00 sec	2.0 to 10.0 VDC	150	100	MANUAL

# Pre-Set MFT Configurations

## Floating Point Control



### Spring Return Actuators



AFX24-MFT(-S)	180 in-lb
AF24-MFT(-S) US	133 in-lb
NFX24-MFT(-S)	90 in-lb
NF24-MFT US	60 in-lb
LF24-MFT(-S) US	35 in-lb
LF24-MFT(-S)-20 US	35 in-lb
TF24-MFT US	18 in-lb

### Non-Spring Return Actuators



GMX24-MFT	360 in-lb
AMX24-MFT	180 in-lb
NMX24-MFT	90 in-lb
LMX24-MFT	45 in-lb
AHX24-MFT	101 lbf
LHX24-MFT	34 lbf
LUX24-MFT	27 in-lb

### Application

How the MFT actuator performs is determined by the configuration (P-10001, A01). The old generation actuators used a P-code (P-10001). The new generation actuators use a shorter 3 digit code. This shorter code is displayed on the reorder number.

P-3000... configuration types are used for floating point control outputs. In this application MFT actuators offer constant running time and standard feedback options. A IN4004 or IN4007 diode is required for original spring return actuators only.

### Wiring Diagram

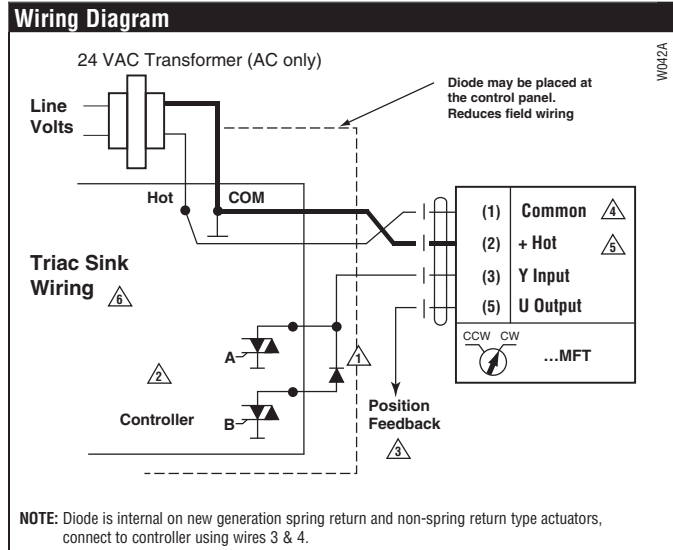

### Wiring Diagram

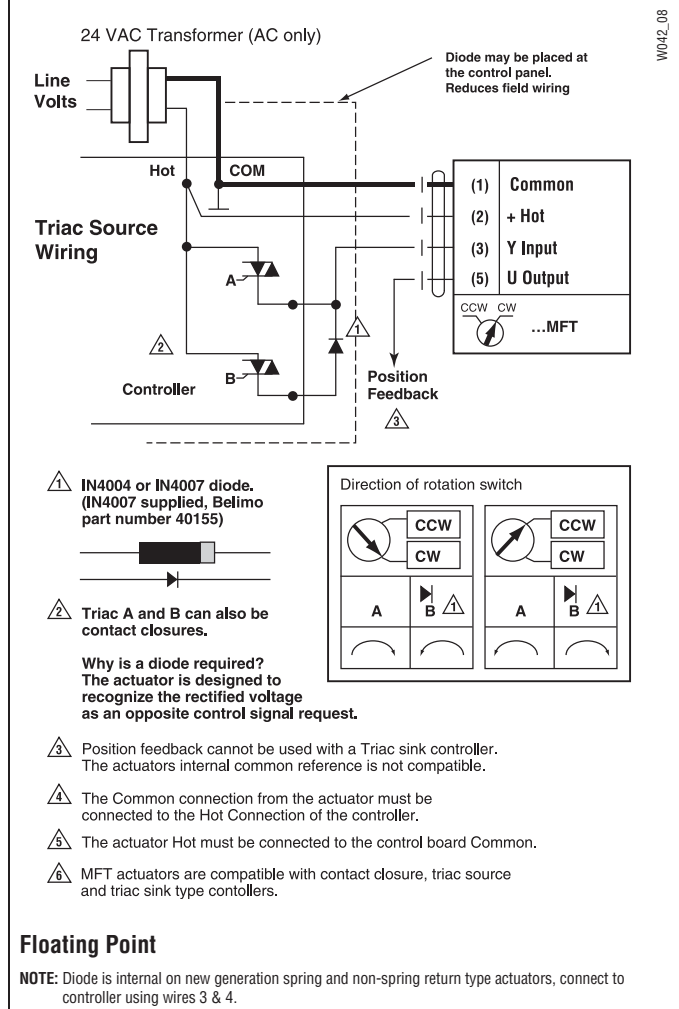

### Select Configuration

	Configuration	Code	Input Range	Position Feedback	Running Time	Torque %	Adaptation
Floating Point Control	P-30001	F01	Floating Point	2.0 to 10.0 VDC	150	100	MANUAL
	P-30002	F02	Floating Point	0.5 to 10.0 VDC	150	100	MANUAL
	P-30003	F03	Floating Point	2.0 to 10.0 VDC	100	100	MANUAL
	P-30004	F04	Floating Point	0.5 to 5.0 VDC	100	100	MANUAL
	P-30005	F05	Floating Point	0.5 to 10.0 VDC	100	100	MANUAL
	P-30006	F06	Floating Point	0.5 to 5.0 VDC	150	100	MANUAL
	P-30007	F07	Floating Point	2.0 to 10.0 VDC	300	100	MANUAL
	P-30008	F08	Floating Point	2.0 to 10.0 VDC	75	100*	MANUAL
	P-30009	F09	Floating Point	2.0 to 10.0 VDC	85	100*	MANUAL
	P-30010	F10	Floating Point	0.5 to 2.5 VDC	150	100	MANUAL

\* Reduced torque in Spring Return (see page 19)

#### Spring Return Actuators



AFX24-MFT(-S)	180 in-lb
AF24-MFT(-S) US	133 in-lb
NFX24-MFT(-S)	90 in-lb
NF24-MFT US	60 in-lb
LF24-MFT(-S) US	35 in-lb
TF24-MFT US	18 in-lb

#### Non-Spring Return Actuators



GMX24-MFT	360 in-lb
AMX24-MFT	180 in-lb
NMX24-MFT	90 in-lb
LMX24-MFT	45 in-lb
AMQX24-MFT	140 in-lb
NMQX24-MFT	70 in-lb
LMQX24-MFT	35 in-lb
AHX24-MFT	101 lbf
AHQX24-MFT-100	44 lbf
LHX24-MFT	34 lbf
LHQX24-MFT-100	22 lbf
LUX24-MFT	27 in-lb

#### Application

How the MFT actuator performs is determined by the configuration (P-10001, A01). The old generation actuators used a P-code (P-10001). The new generation actuators use a shorter 3 digit code. This shorter code is displayed on the reorder number.

P-4000... configuration types are used for on/off control outputs. The configuration allows for service replacement of on/off actuators when a true on/off actuator is not available.

In addition the MFT actuator offers additional functionality in the on/off mode, such as configuration P-40003 with minimum position and 2 to 10 VDC feedback.

#### Wiring Diagram

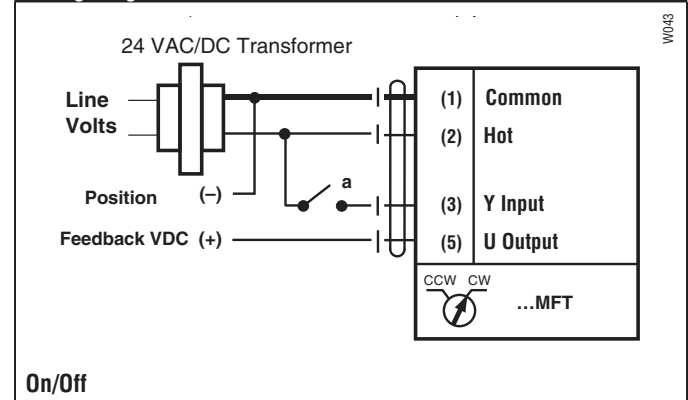

M40035 - 05/10 - Subject to change. © Belimo Aircontrols (USA), Inc.

#### Select Configuration

	Configuration	Code	Input Range	Position Feedback	Running Time	Torque %	Adaptation
<b>On/Off Control</b>	P-40001	J01	On/Off	2.0 to 10.0 VDC	75	100*	MANUAL
	P-40002	J02	On/Off	2.0 to 10.0 VDC	150	100	MANUAL
	P-40003	J03	On/Off	2.0 to 10.0 VDC	75	100*	MANUAL
	P-40004	J04	On/Off	0.5 to 5.0 VDC	100	100	MANUAL
	P-40005	J05	On/Off	0.5 to 10.0 VDC	100	100	MANUAL

\* Reduced torque in Spring Return (see page 19)

All MFT actuators have built-in brushless DC motors which provide better accuracy and longer service life.

**Control Accuracy and Stability  
(AF / NF / LF / TF)**

The ...MFT US actuators are designed with a unique non-symmetrical deadband. The actuator follows an increasing or decreasing control signal with a 80 mV resolution. If the signal changes in the opposite direction, the actuator will not respond until the control signal changes by 200 mV. This allows these actuators to track even the slightest deviation very accurately, yet allowing the actuator to "wait" for a much larger change in control signal due to control signal instability.

**AF / NF / LF / TF Actuators responds to a 80 mV signal when not changing direction from stop position.**

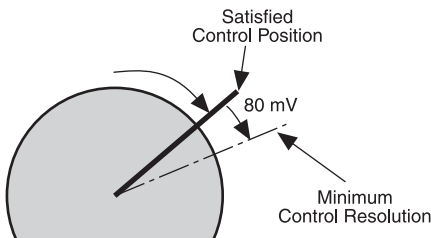

**AF / NF / LF / TF Actuators responds to a 200 mV signal when reversing direction from stop position.**

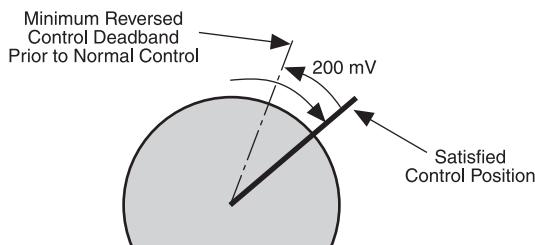

**Control Accuracy and Stability  
(GM / AM / NM / LM / AH / LH / LU / GR / AR / LR)**

Belimo non-spring return actuators are designed with a unique non-symmetrical deadband. The actuator follows an increasing or decreasing control signal with a 75 mV resolution. If the signal changes in the opposite direction, the actuator will not respond until the control signal changes by 175 mV. This allows these actuators to track even the slightest deviation very accurately, yet allowing the actuator to "wait" for a much larger change in control signal due to control signal instability.

**Actuator responds to a 75 mV signal when not changing direction from stop position.**

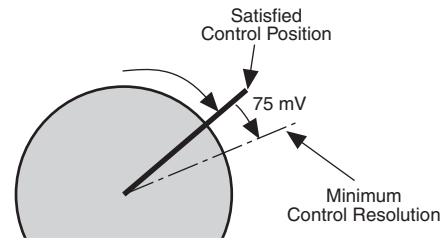

**Actuator responds to a 175 mV signal when reversing direction from stop position.**

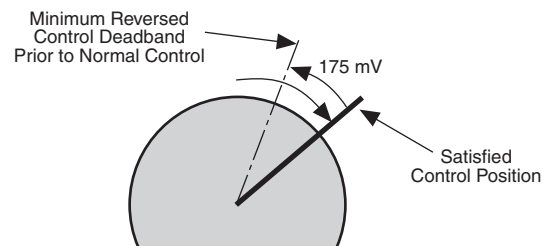

IM40035 - 05/10 - Subject to change. © Belimo Aircontrols (USA), Inc.

All Belimo actuators have built-in brushless DC motors which provide better accuracy and longer service life.

**Control Accuracy and Stability  
(AMQ / NMQ / LMQ / AHQ / LHQ)**

Belimo Quick Running non-spring return actuators are designed with a unique non-symmetrical deadband. The actuator follows an increasing or decreasing control signal with a 40 mV resolution. If the signal changes in the opposite direction, the actuator will not respond until the control signal changes by 100 mV. This allows these actuators to track even the slightest deviation very accurately, yet allowing the actuator to “wait” for a much larger change in control signal due to control signal instability.

**Actuator responds to a 40 mV signal when not changing direction from stop position.**

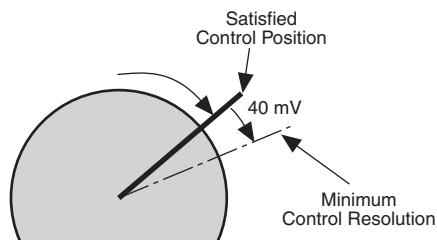

**Actuator responds to a 100 mV signal when reversing direction from stop position.**

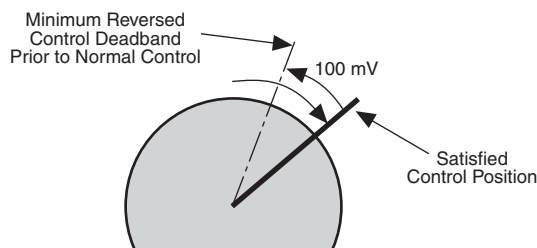

M40035 - 05/10 - Subject to change. © Belimo Aircontrols (USA), Inc.

Motion	Parameter Variables	Description
<b>Running Time</b>	<b>New Generation AF</b>	70 to 220 seconds
	<b>New Generation NF</b>	40 to 220 seconds
	<b>AF / NF / LF / TF</b>	75 to 300 seconds
	<b>GM</b>	75 to 300 seconds
	<b>AM*</b>	90 to 350 seconds
	<b>NM*</b>	45 to 150 seconds
	<b>AH*</b>	75 to 150 seconds
	<b>LM*</b>	35 to 150 seconds
	<b>LH*</b>	75 to 150 seconds
	<b>LU</b>	75 to 150 seconds
<b>Rotation</b>	<b>Direction of Rotation</b>	Default or Reversed
	<b>Intermediate Position Control (Override Control)</b>	<ul style="list-style-type: none"> <li>• Minimum Position (Default 0%)</li> <li>• Intermediate Position (Default 50%)</li> <li>• Maximum Position (Default 100%)</li> </ul> Intermediate Positions are achieved through 'forced override' positions. <b>SEE FIGURE A – FORCED OVERRIDES.</b>

Running time is selectable allowing for customizing the actuator for the application at hand. Adjustable running time allows for:

- Matching HVAC system sequence of operation.
- Improving control loop stability.
- Reducing actuating noise (slower running).
- Retrofit applications

The running time is constant and independent of load.

The direction of rotation can be "Direct" or "Reverse" acting of the control signal. The direction of rotation is selected from a CW and CCW switch located on the actuator.

An alternative method of changing the direction of rotation is to use the PC-Tool software. This option allows you to make remote set-up corrections without having the need to be at the actuator.

Selection of the direction of rotation is only possible via the PC-Tool software or manually with the switch on the actuator. Selection via a preset configuration is not an option.

All intermediate settings are adjustable from 0 to 100%. Programmed as default, these control positions are possible by using the wiring diagram in **FIGURE A**. The override functions can be used as a means to test the actuator's functionality during equipment servicing or troubleshooting. Intermediate positions can also be integrated into the control circuit as a part of the sequence of operation.

The Min, Mid, and Max positions can be used in any MFT control mode.

- VDC: For stand-alone controllers where a minimum position is needed.
- PWM: Eliminate add-on accessories.
- Floating Point: New functionality to a common application.
- On/Off: New functionality to a common application.
  - Satisfy combustion air requirements or boiler sequencing with O/A damper.
  - Eliminates secondary minimum position dampers.

\* Quicker running actuators are available. Contact Belimo Customer Service for details.

**FIGURE A – Forced Overrides**

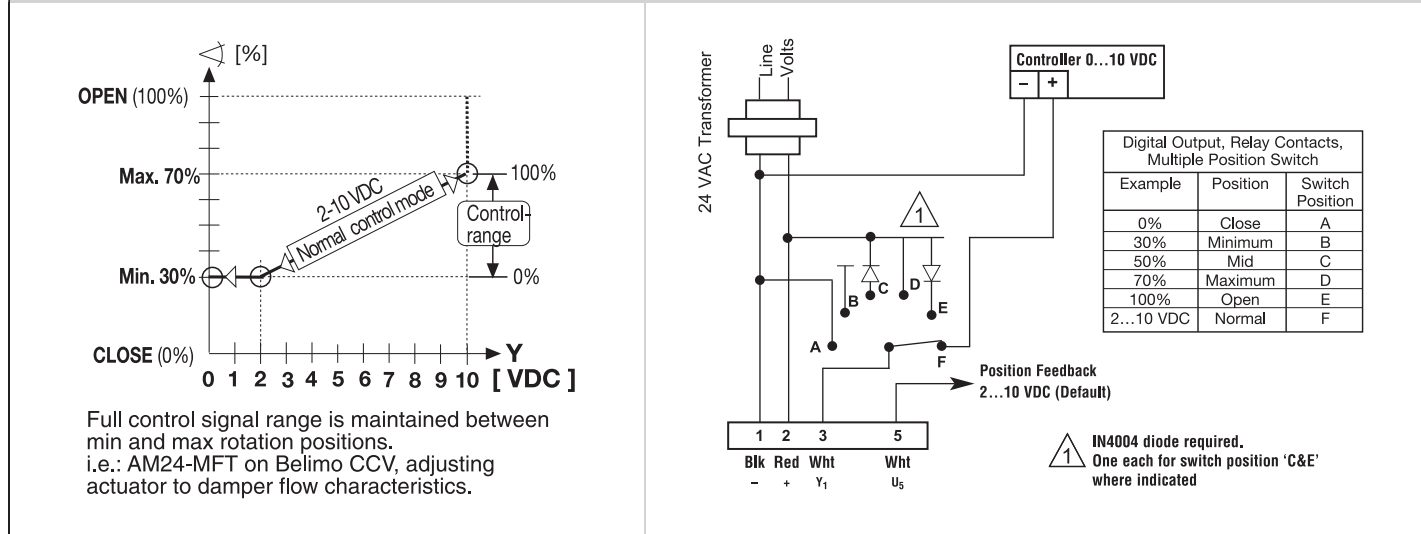

IM40035 - 05/10 - Subject to change. © Belimo Aircontrols (USA), Inc.

	Motion	Parameter Variables	Description
	Adaptation	OFF	When the manual override button is depressed, and released, the actuator will perform synchronization. The actuator will simply drive to the mechanical zero position and return to its last control position.
		ON – Manual	The default setting for adaptation is “ON – Manual”. When the ON-Manual setting is selected, adaptation is initiated by: <ul style="list-style-type: none"> <li>Pressing the manual override button twice (GM / AM / NM / LM).</li> <li>Clicking the CW/CCW switch twice (AF, NF, LF and TF).</li> </ul> When adaptation is selected, (On-Manual or Automatic) the actuator will drive one full cycle to its mechanical end stops OR the valves mechanical seats. Upon completion of this cycle the actuators working range (input, feedback and running time) will be adapted to the actual mechanical angle of rotation.
		ON – Automatic	When the ON-Automatic setting is selected at every power-up the actuator will automatically adapt to the mechanical angle of rotation. Also upon pressing the manual override button or CW/CCW switch, adaptation is initiated (See above).
Mechanical Relationship	Sound and Running Time	All Actuators	As the speed of the actuator increases, there is an increase in the sound power level.
	Torque and Running Time	Original Spring Return (AF / NF / LF)	Though the running time remains constant, at approximately the 100-second range there is a loss in output torque. This is due to the association of runtime to torque. To gain a faster running time there is a loss in torque. <b>SEE FIGURE B.</b>

M440035 - 05/10 - Subject to change. © Belimo Aircontrols (USA), Inc.

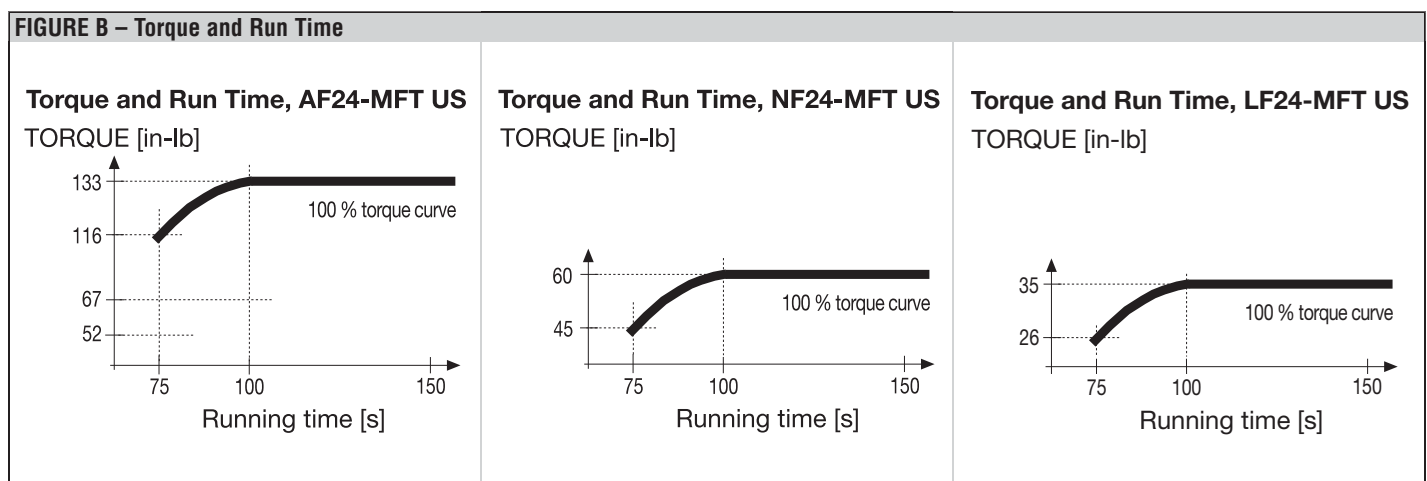

**NOTE: All new generation spring return and non-spring return actuators are torque independent of speed.**

Specifications	Parameter Variables	Description
<b>Alarms - Fault</b> A fixed voltage of 8.5 VDC is present when Alarm 'sounds'.	Hunting $\frac{A_t(h) \times 100}{O_t(h)} = \text{Motion Percentage}$ $\frac{140 \times 100}{700} = 20\%$	Alarm criteria: Actuator is hunting due to unstable control loop. This fault occurs when the ratio of Active time to Operating time exceeds 20%. Operating time: Total number of hours connected to power supply Active time: Total number of hours the actuator is in mechanical motion.
	Mechanical Overload	Alarm criteria: Actuator is in a position and not responding to the control input. An alarm will 'sound' when an object or circumstance is preventing the motion of the actuator, damper or valve. The actuator has initiated its own overload protection after a period of 13 seconds.
	Mechanical Travel	Alarm criteria: Actuator is adapted to the working angle of a damper or to the stroke of a valve and is less than 95-degree actuator rotation (eg. 75° adapted angle). An alarm will 'sound' when the actuator detects a mechanical travel difference of 10% above the adapted angle (eg. 82.6°).
<b>Alarm - Maintenance</b> A fixed voltage of 5.5 VDC is present when Alarm 'sounds'.	Mechanical load limit (Non-Spring Return Only)	Alarm criteria: The torque load of the application has exceeded the actuator's torque. A typical scenario – the torque requirements has increased due to: <ul style="list-style-type: none"> <li>• Lack of lubrication</li> <li>• Increased flow</li> <li>• Improper installation</li> <li>• Damage</li> <li>• Dirt and debris build-up</li> </ul> The alarm 'sounds' when the specified torque rating of the actuator has been exceeded for a period of 5 seconds.



	Service	Parameter Variables	Description
<b>Displays</b>	<b>Identification</b>	Serial Number	Displays the actuators internal serial number.
		Actuator Type / Software Version	Displays the actuator nomenclature (AFX24-MFT US) and MFT software version.
		Assembly Location	Displays the where the actuator was assembled.
		Setpoint	Displays the actual control input position as a percentage. As signal input changes you will see the setpoint percentage change accordingly.
	<b>Actual Values</b>	Actual Position	Displays the actual position as a percentage. As the setpoint changes the actual position percentage will increase or decrease accordingly. If the actuator is capable of rotating the damper or valve, this can be of benefit when troubleshooting an application.
	<b>Function</b>	Control Type & Setting	Displays the actual control type and operating range.
		Feedback Type & Setting	Displays the actual feedback signal type and operating range.
		Torque % Setting	Displays the actual torque setting, as a percentage of minimum torque.
		Running Time	Displays the actual running time as programmed in seconds.
		Direction of Rotation	Displays the status of the direction of rotation option (Normal or Reversed).
		Min, Mid, Max Position	Displays the actual position setting of the Intermediate position control.
		Adaptation	Displays the actual setting of the adaptation function (OFF, ON-Manual, ON-Automatic).
		Sensitivity / Hysteresis	Displays the actual setting of the sensitivity (Normal or Reduced).
	<b>Data Log</b>	Total Time / Operating Time	Total number of hours the actuator is connected to a power supply.
Active Time		Total number of hours the actuator is in motion.	
Stop / Go Ratio (Hunting %)		Displays a percentage the total number of hours the actuator has spent in mechanical motion, comparing the total time to the active time.	
<b>Sensitivity</b>	Normal, Reduced	Displays the setting of the sensitivity function.	
<b>Functions</b>	<b>Messages</b>		Displays all messages present. Messages can be deleted as well.
	<b>Function Test</b>		<p>This function enables you to check for complete opening and closing of the actuator.</p> <p>The test report contains:</p> <ul style="list-style-type: none"> <li>• Information on the Project</li> <li>• Identification on the Actuator</li> <li>• A list of fault messages pending before the start of the test</li> <li>• The test steps and results</li> <li>• The current actuator settings</li> </ul> <p>This is of benefit when troubleshooting an application, as the actuator will drive the damper or valve. This gives an opportunity to observe the installation to identify any possible problems.</p>
	<b>Adaptation</b>	<b>See Adaptation on page 13.</b>	<p>Initiates the adaptation feature of the MFT actuator. The actuators working range (input, feedback, and running time) will be adapted to the actual angle of rotation.</p> <p>This is of benefit when troubleshooting an application, as the actuator will drive the damper or valve. This gives you an opportunity to observe the installation to identify any possible problems.</p>
	<b>Synchronization</b>	Normal	At initial commissioning, when the manual override button is pressed, the actuator runs to a default position defined by the position of the CW/CCW direction of rotation switch.
Sync at 0%		At each power-up (includes power failures), the actuator runs to a default position defined by the position of the CW/CCW direction of rotation switch.	
Sync at 100%		At each power-up (includes power failures), the actuator runs to a default position of the CW/CCW direction of rotation switch.	

M40035 - 05/10 - Subject to change. © Belimo Aircontrols (USA), Inc.

## Wiring



**WARNING** The wiring technician must be trained and experienced with electronic circuits. Disconnect power supply before attempting any wiring connections or changes. Make all connections in accordance with wiring diagrams and follow all applicable local and national codes. Provide disconnect and overload protection as required. Use copper, twisted pair, conductors only. If using electrical conduit, the attachment to the actuator must be made with flexible conduit.

**Always read the controller manufacturer's installation literature carefully before making any connections.** Follow all instructions in this literature. If you have any questions, contact the controller manufacturer and/or Belimo.

### Transformer(s)

Non-spring return actuators require a 24 VAC class 2 transformer and draws a maximum of 5 VA per actuator. The actuator enclosure cannot be opened in the field, there are no parts or components to be replaced or repaired.

- EMC directive: 89/336/EEC
- Software class A: Mode of operation type 1
- Low voltage directive: 73/23/EEC

**CAUTION:** It is good practice to power electronic or digital controllers from a separate power transformer than that used for actuators or other end devices. The power supply design in our actuators and other end devices use half wave rectification. Some controllers use full wave rectification. When these two different types of power supplies are connected to the same power transformer and the DC commons are connected together, a short circuit is created across one of the diodes in the full wave power supply, damaging the controller. Only use a single power transformer to power the controller and actuator if you know the controller power supply uses half wave rectification.

### Typical Transformer Sizing

Actuator Series	Voltage	Required VA Per Actuator
New Generation AF	24	10*
Original AF	24	10
New Generation NF	24	9**
Original NF	24	6
LF	24	6
TF	24	4
GMB/GRB	24	7
AMB/ARB	24	6
NMB	24	6
LMB/LRB	24	5
AHB	24	6
LHB	24	5
LUB	24	5
AMQB	24	18
NMQB	24	18
LMQB	24	18
AHQB	24	18
LHQB	24	18

- \* @ 70 second run time  
 \*\* @ 40 second run time

### Multiple Actuators, One Transformer

Multiple actuators may be powered from one transformer provided the following rules are followed:

1. The TOTAL current draw of the actuators (VA rating) is less than or equal to the rating of the transformer.
2. Polarity on the secondary of the transformer is strictly followed. *This means that all No. 1 wires from all actuators are connected to the common leg on the transformer and all No. 2 wires from all actuators are connected to the hotleg.* Switching wire No. 1 & 2 on one leg of the transformer will result in erratic operation or failure of the actuator and/or controls.

### Multiple Actuators, Multiple Transformers

Multiple actuators positioned by the same control signal may be powered from multiple transformers provided the following rules are followed:

1. The transformers are properly sized.
2. All No. 1 wires from all actuators are tied together and tied to the negative leg of the control signal. See wiring diagram on page 11.

### Wire Lengths for Actuators

Keep power wire runs below the lengths listed in the **Figure H**. If more than one actuator is powered from the same wire run, divide the allowable wire length by the number of actuators to determine the maximum run to any single actuator.

Example: 3 actuators, 16 Ga wire  
 350 Ft ÷ 3 Actuators = 117 Ft. Maximum wire run

LH-24.../LU-24...		LM-24.../CM24	
Wire Size	Max. Feet.	Wire Size	Max. Feet
16 Ga	1175 Ft.	16 Ga	1125 Ft.
18 Ga	1075 Ft.	18 Ga	750 Ft.
20 Ga	575 Ft.	20 Ga	400 Ft.
22 Ga	300 Ft.	22 Ga	200 Ft.

NM-24.../AH-24.../LMX120...		AM-24...	
Wire Size	Max. Feet.	Wire Size	Max. Feet
12 Ga	1250 Ft.	12 Ga	1150 Ft.
14 Ga	1130 Ft.	12 Ga	925 Ft.
16 Ga	900 Ft.	16 Ga	550 Ft.
18 Ga	575 Ft.	18 Ga	375 Ft.
20 Ga	300 Ft.	20 Ga	200 Ft.
22 Ga	150 Ft.	22 Ga	100 Ft.

GM.../NMX120.../AMX120...			
Wire Size	Max. Feet.	Wire Size	Max. Feet
12 Ga	1125 Ft.	18 Ga	325 Ft.
14 Ga	800 Ft.	20 Ga	175 Ft.
16 Ga	500 Ft.	22 Ga	90 Ft.

**FIGURE H – Maximum Wire Lengths**

### Wire Type and Wire Installation Tips

For most installations, 18 or 16 Ga. cable works well with the non-spring return actuators. Use code-approved wire nuts, terminal strips or solderless connectors where wires are joined. It is good practice to run control wires unspliced from the actuator to the controller. If splices are unavoidable, make sure the splice can be reached for possible maintenance. Tape and/or wire-tie the splice to reduce the possibility of the splice being inadvertently pulled apart.

The non-spring return proportional actuators have a digital circuit that is designed to ignore most unwanted input signals (pickup). In some situations the pickup may be severe enough to cause erratic running of the actuator. For example, a large inductive load (high voltage AC wires, motors, etc.) running near the power or control wiring may cause excessive pickup. To solve this problem, make one or more of the following changes:

1. Run the wire in metallic conduit.
2. Re-route the wiring away from the source of pickup.
3. Use shielded wire (Belden 8760 or equal). Ground the shield to an earth ground. Do not connect it to the actuator common.

IM40035 - 05/10 - Subject to change. © Belimo Aircontrols (USA), Inc.

**ATTENTION**

Master-Slave is the correct method for wiring multiple Belimo MFT actuators to a single load. For example, you can have up to three AFX24-MFT on a single damper jackshaft or two GMX24-MFT on a large butterfly valve.

The current Belimo solution is to mount multiple actuators onto the damper or valve. In the past this required the installer to wire the actuators in a “master-slave” arrangement. This was typical for the AF24-SR US actuator.

By adding more actuators you can effectively increase the torque proportional to the minimum specified torque times the number of actuators. This is normal as seen on the following installations.

- Large dampers or valves
- Rack and Pinion style globe valves
- Large multiple section dampers
- Ball or Butterfly valves

**Multiple actuators mounted to one control shaft**

Model	Max. Qty Per Shaft	Torque Generated
AFX24-MFT(-S)	3	432 in-lb
NFX24-MFT(-S)	1	90 in-lb
LF24-MFT(-S) US	1	35 in-lb
GMX24-MFT	2	640 in-lb
AMX24-MFT	1	180 in-lb
NMX24-MFT	1	90 in-lb
LMX24-MFT	1	45 in-lb
GKX24-MFT	2	720 in-lb

The wiring method for multiple actuators mounted to shafts which are **not** mechanically connecting other actuators is to wire the control signal in parallel with each actuator.

**Multiple XM24-MFT95...**

**EXCEPTION** No mechanical dual mounting of AFX24-MFT US is possible. Electrical parallel wiring of AFX24-MFT95 is possible only for mechanically separate applications.

**SOLUTION** For increased torque requirement use AFX24-MFT95 as a master and the slave must be an AFX24-MFT. The masters feedback must match the slaves input signal. (Both are default 2-10 VDC.)

**Wiring Diagrams**

**INSTALLATION NOTES**

1 Provide overload protection and disconnect as required.

2 **CAUTION Equipment damage!** Actuators may be connected in parallel if not mechanically mounted to the same shaft. Power consumption and input impedance must be observed.

3 Actuators may also be powered by 24 VDC.

5 Control signal may be pulsed from either the Hot (source) or the Common (sink) 24 VAC line.

**APPLICATION NOTES**

◆ The ZG-R01 500 Ω resistor may be used.

**WARNING Live Electrical Components!**

During installation, testing, servicing and troubleshooting of this product, it may be necessary to work with live electrical components. Have a qualified licensed electrician or other individual who has been properly trained in handling live electrical components perform these tasks. Failure to follow all electrical safety precautions when exposed to live electrical components could result in death or serious injury.

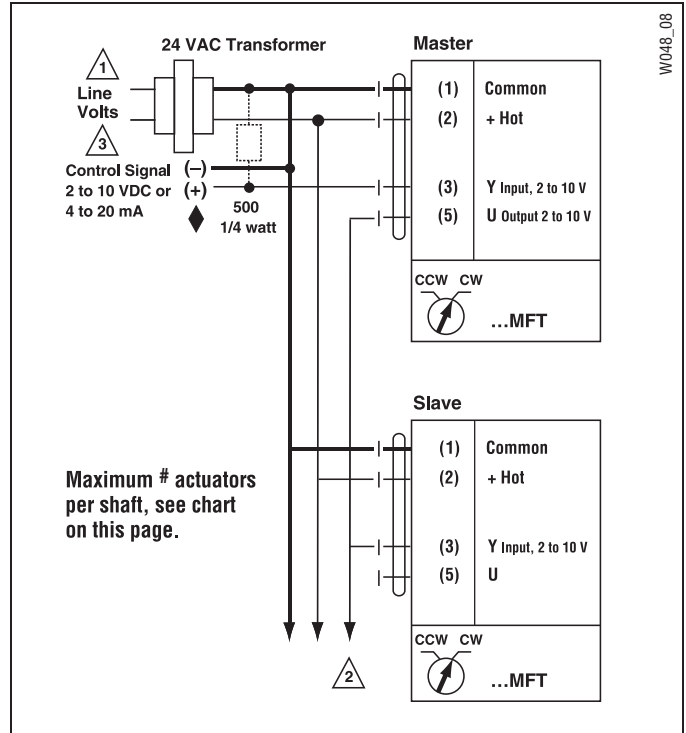

Wiring multiple ...MFT actuators to one shaft.

All MFT actuators are wired in master-slave configuration.

Wiring of multiple ...MFT actuators on valves must be master-slave (wires 3-5).

MFT actuator configurations should also co-ordinate with each other. Meaning the master input = controllers output. Master output = slave input. Slave output = controller input.

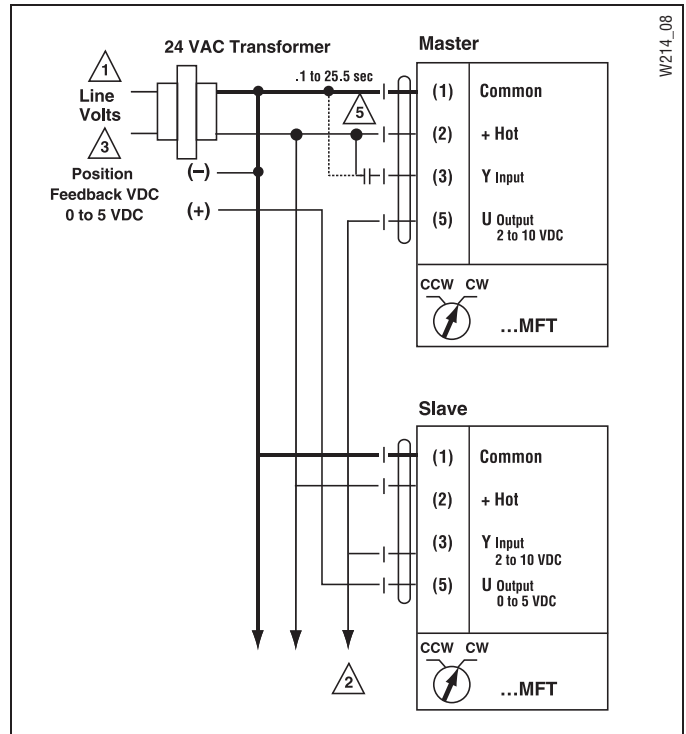

Controller Output	Master Feedback	Slave Input	Slave Feedback
0.1 to 25.5 sec	2 to 10 VDC	2 to 10 VDC	0 to 5 VDC

M40035 - 05/10 - Subject to change. © Belimo Aircontrols (USA), Inc.

### Spring Return Actuator with MFT

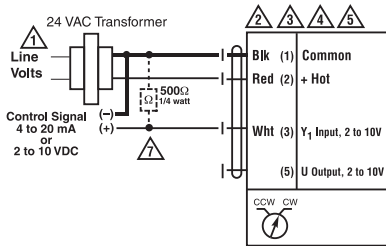

VDC / 4 to 20mA

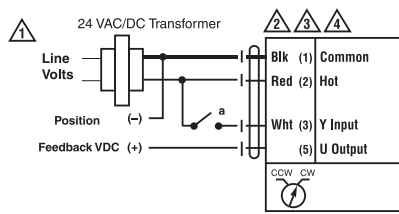

Two Position

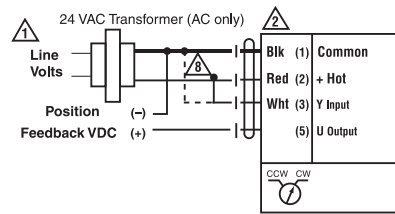

PWM

### Original AF, NF, LF, TF

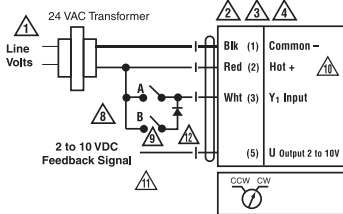

### New Generation AF, NF

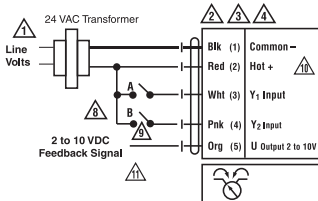

Floating Point

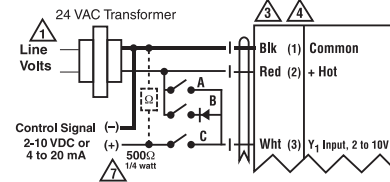

Functions	a	b	c
Min*	0% <math>\triangleleft</math>	—	—
Mid*	50% <math>\triangleleft</math>	—	—
Max*	100% <math>\triangleleft</math>	—	—
Normal**	Control mode acc. to Y	—	—

\* Default selectable 0-100%. See Configuration Data Sheet  
 \*\* Customizable. See Configuration Data Sheet.

Override control to min, mid, max positions

- 1 Provide overload protection and disconnect as required.
- 2 Actuators may be connected in parallel if not mechanically mounted to the same shaft. Power consumption and input impedance must be observed.
- 3 Actuators may also be powered by 24 VDC.
- 4 Meets cULus requirements without the need of an electrical ground connection.
- 5 Actuators with plenum rated cable do not have numbers on wires; use color codes instead. Actuators with appliance cables are numbered.
- 7 A 500Ω resistor converts the 4 to 20 mA control signal to 2 to 10 VDC.
- 8 Control signal may be pulsed from either the Hot (Source) or Common (Sink) 24 VAC line.
- 9 Contact closures A & B also can be triacs. A & B should both be closed for triac source and open for triac sink.
- 10 For triac sink the Common connection from the actuator must be connected to the Hot connection of the controller.
- 11 Position feedback cannot be used with a Triac sink controller. The actuator internal common reference is not compatible.
- 12 IN4004 or IN4007 diode. (IN4007 supplied, Belimo part number 40155)

W425\_08

### Non-Spring Return Actuator with MFT

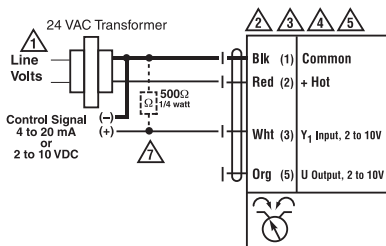

VDC / 4 to 20mA

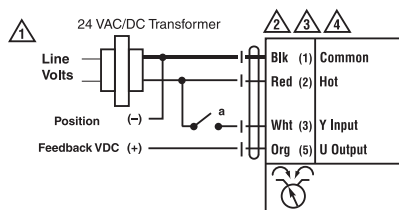

Two Position

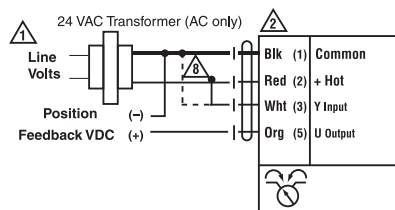

PWM

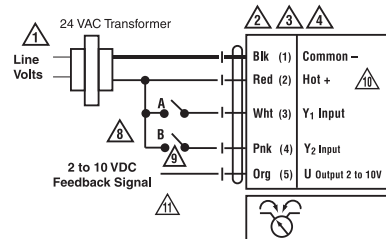

Floating Point

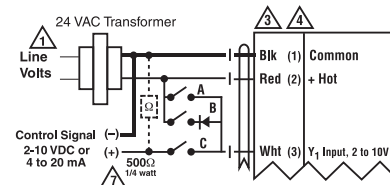

Functions	a	b	c
Min*	0% <math>\triangleleft</math>	—	—
Mid*	50% <math>\triangleleft</math>	—	—
Max*	100% <math>\triangleleft</math>	—	—
Normal**	Control mode acc. to Y	—	—

\* Default selectable 0-100%. See Configuration Data Sheet  
 \*\* Customizable. See Configuration Data Sheet.

Override control to min, mid, max positions

- 1 Provide overload protection and disconnect as required.
- 2 Actuators may be connected in parallel if not mechanically mounted to the same shaft. Power consumption and input impedance must be observed.
- 3 Actuators may also be powered by 24 VDC.
- 4 Meets cULus requirements without the need of an electrical ground connection.
- 5 Actuators with plenum rated cable do not have numbers on wires; use color codes instead. Actuators with appliance cables are numbered.
- 7 A 500Ω resistor converts the 4 to 20 mA control signal to 2 to 10 VDC.
- 8 Control signal may be pulsed from either the Hot (Source) or Common (Sink) 24 VAC line.
- 9 Contact closures A & B also can be triacs. A & B should both be closed for triac source and open for triac sink.
- 10 For triac sink the Common connection from the actuator must be connected to the Hot connection of the controller.
- 11 Position feedback cannot be used with a Triac sink controller. The actuator internal common reference is not compatible.

W426\_08

### 0 to 135 Ω Control (MFT95)

Switch A	Switch B	Damper Position
		Damper Open
		Damper Closed

The direction of rotation switch is set so that the fail safe position and the position of the damper is closed with no signal at wire R.

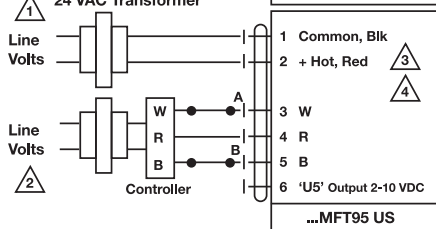
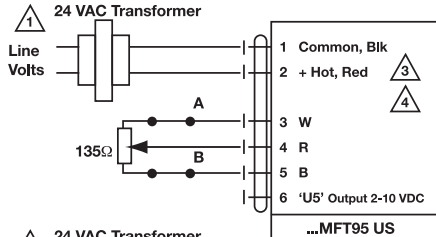

### Override

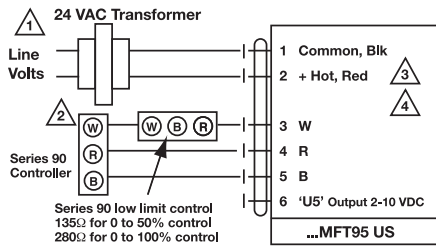

### Low Limit Control

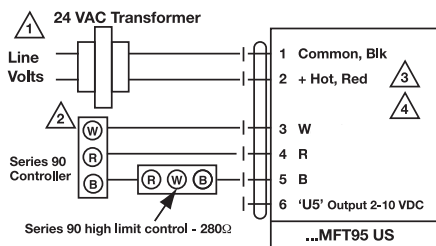

### High Limit Control

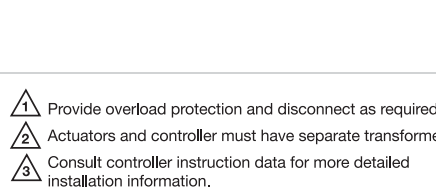

- Provide overload protection and disconnect as required.
- Actuators and controller must have separate transformers.
- Consult controller instruction data for more detailed installation information.

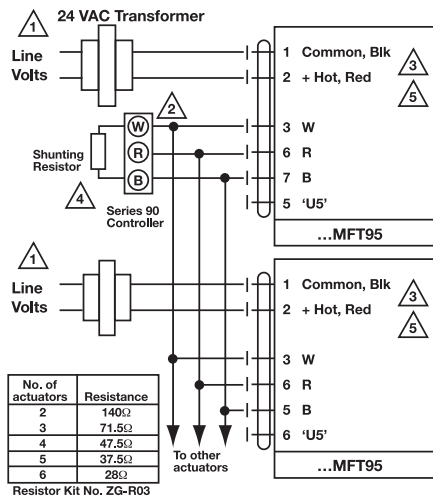

### Wiring multiple actuators to a Series 90 controller

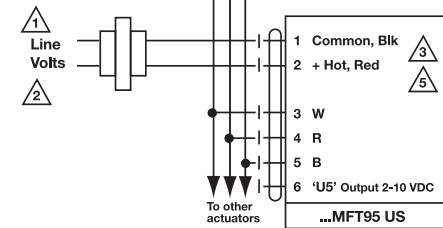
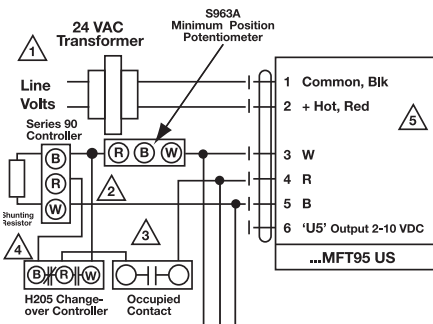

### Wiring multiple actuators to a Series 90 controller using a minimum position potentiometer

- Resistor value depends on the type of controller and the number of actuators. No resistor is used for one actuator. Honeywell resistor kits may also be used.
- To reverse control rotation, use the reversing switch.

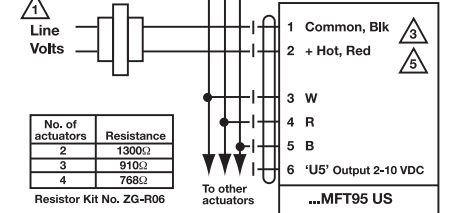
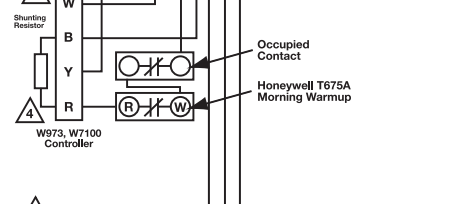
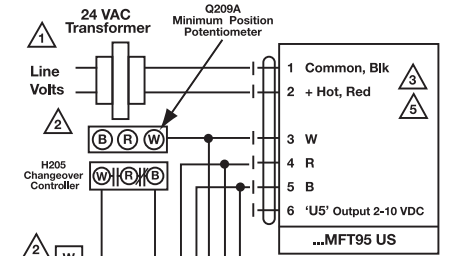

### Used with the W973 and W7100 controllers.

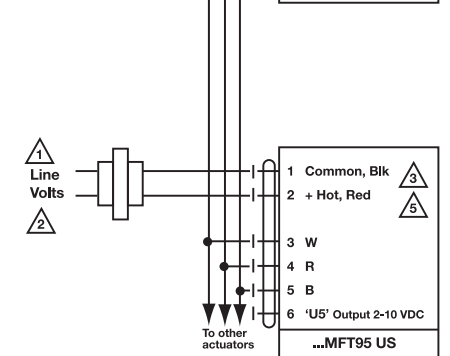
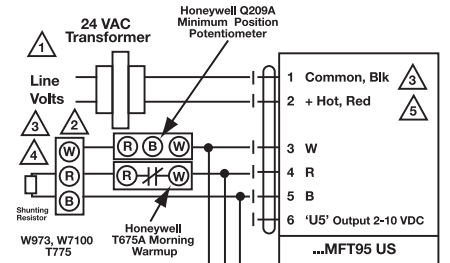

### Typical wiring diagrams for multiple actuators used with the W973, W7100 and T775 controllers.

M40035 - 05/10 - Subject to change. © Belimo Aircontrols (USA), Inc.

#### AF24-MFT95 US Wire Colors

1=Black	3=White	5=White
2=Red	4=White	6=White

#### AFX24-MFT95 and Non-Spring Return Wire Colors

1=Black	3=White	5=Gray
2=Red	4=Pink	6=Orange

\*Note: Not every code works with every acuator

Programmable Code	Running Time	Control Range	Feedback	Feedback Range	Obsolete Code	MP Bus Logo	Adaption
A01	150s	2...10V	U5	U5 2...10V	P-10001	NO	manual
A02	150s	0.5...10V	U5	U5 0.5...10V	P-10002	NO	manual
A03	150s	2...10V	U5	U5 0.5...5V	P-10003	NO	manual
A04	150s	4...7V	U5	U5 2...10V	P-10004	NO	manual
A05	150s	6...9V	U5	U5 2...10V	P-10005	NO	manual
A06	150s	10.5...13.5V	U5	U5 2...10V	P-10006	NO	manual
A07	150s	0.5...5V	U5	U5 2...10V	P-10007	NO	manual
A08	150s	0.5...5V	U5	U5 0.5...10V	P-10008	NO	manual
A09	150s	5...10V	U5	U5 2...10V	P-10009	NO	manual
A10	150s	5...10V	U5	U5 0.5...10V	P-10010	NO	manual
A11	150s	0.5...5V	U5	U5 0.5...5V	P-10011	NO	manual
A12	150s	0.5...5V	U5	U5 0.5...2.5V	P-10012	NO	manual
A13	150s	0.5...10V	U5	U5 2...10V	P-10013	NO	manual
A14	100s	0.5...10V	U5	U5 0.5...2.5V	P-10014	NO	manual
A15	150s	2...5V	U5	U5 2...10V	P-10015	NO	manual
A16	150s	2...6V	U5	U5 2...10V	P-10016	NO	manual
A17	150s	6...10V	U5	U5 2...10V	P-10017	NO	manual
A18	150s	14...17V	U5	U5 2...10V	P-10018	NO	manual
A19	100s	2...10V	U5	U5 2...10V	P-10019	NO	manual
A20	150s	9...12V	U5	U5 2...10V	P-10020	NO	manual
A21	150s	2...10V	U5	U5 0.5...5V	P-10021	NO	manual
A22	150s	0.5...4.9V	U5	0.5...4.9V	P-10022	NO	manual
A23	150s	5.1...10V	U5	5.1...10V	P-10023	NO	manual
A24	150s	0.5...24V	U5	U5 2...10V	P-10024	NO	manual
A25	76s	2...10V	U5	U5 2...10V	P-10025	NO	manual
A26	150s	2...9V	U5	U5 2...10V	P-10026	NO	manual
A27	150s	5...9V	U5	U5 2...10V	P-10027	NO	manual
A28 PICCV ONLY	100s	0.5...10V	U5	U5 0.5...10V	P-10028	NO	manual
A29	150s	1...3V	U5	U5 2...10V	P-10029	NO	manual
A30	150s	3...9V	U5	U5 2...10V	P-10030	NO	manual
A31	150s	0.5...4V	U5	U5 2...10V	P-10031	NO	manual
A32	150s	6...14V	U5	U5 2...10V	P-10032	NO	manual
A33	150s	4...14V	U5	U5 2...10V	P-10033	NO	manual
A34	120s	2...10V	U5	U5 2...10V	P-10034	NO	manual
A35	78s	2...10V	U5	U5 2...10V	P-10035	NO	manual
A37	120s	0.5...10V	U5	U5 0.5...10V	P-10037	NO	manual
A38	150s	6...13V	U5	U5 2...10V	P-10038	NO	manual
A39	150s	10...14V	U5	U5 2...10V	P-10039	NO	manual
A40	150s	1...16V	U5	U5 2...10V	P-10040	NO	manual
A41	150s	3...6V	U5	U5 2...10V	P-10041	NO	manual
A42	75s	0.5...10V	U5	U5 2...10V	P-10042	NO	manual
A43	150s	0.5...2.5V	U5	U5 2...10V	P-10043	NO	manual
A44	150s	7...10V	U5	U5 2...10V	P-10044	NO	manual
A45	150s	13...17V	U5	U5 2...10V	P-10045	NO	manual
A46	150s	2...10V	U5	U5 2...10V	P-10046	NO	manual
A47	150s	0.5...20V	U5	U5 2...10V	P-10047	NO	manual
A48	150s	1...5V	U5	U5 1...5V	P-10048	NO	auto-adapt.
A49	150s	1...5V	U5	U5 1...5V	P-10049	NO	auto-adapt.
A51					P-10051		
A52	150s	2...10V	U5	U5 0.5...5V	P-10052	NO	manual
A53	120s	0.5...10V	U5	U5 2...10V	P-10053	NO	manual
A54	150s	0.5...2.5V	U5	U5 0.5...2.5V	P-10054	NO	manual
A55	75s	2...5V	U5	U5 2...10V	P-10055	NO	manual
A56	75s	6...9V	U5	U5 2...10V	P-10056	NO	manual
A57	150s	2...5.5V	U5	U5 2...10V	P-10057	NO	manual
A58	150s	6.5...10V	U5	U5 2...10V	P-10058	NO	manual
A59	150s	0.5...6V	U5	U5 2...10V	P-10059	NO	manual
A60	300s	2...10V	U5	U5 2...10V	P-10060	NO	manual
A61	150s	10...20V	U5	U5 2...10V	P-10061	NO	manual
A62	90s	2...10V	U5	U5 2...10V	P-10062	NO	manual
A63	150s	0.5...4.5V	U5	U5 0.5...4.5V	P-10063	NO	manual
A64	150s	5.5...10V	U5	U5 5.5...10V	P-10064	NO	manual
A65	150s	1...5V	U5	U5 1...5V	P-10065	NO	manual

IM40035 - 05/10 - Subject to change. © Belimo Aircontrols (USA), Inc.

Programmable Code	Running Time	Control Range	Feedback	Feedback Range	Obsolete Code	MP Bus Logo	Adaption
A66	150s	2...10V	U5	U5 1...5V	P-10066	NO	manual
A67	150s	2...8V	U5	U5 2...10V	P-10067	NO	manual
A68	150s	2...13V	U5	U5 2...10V	P-10068	NO	manual
A69	150s	1..4V	U5	U5 2...10V	P-10069	NO	manual
A70	150s	3.5...10V	U5	U5 2...10V	P-10070	NO	manual
A71	150s	2...15V	U5	U5 2...10V	P-10071	NO	manual
A72	95s	2...10V	U5	U5 2...10V	P-10072	NO	manual
A73	150s	6...18V	U5	U5 2...10V	P-10073	NO	manual
A74	150s	2...10V	U5	U5 2...10V	P-10074	NO	manual
A76	150s	0.5...3V	U5	U5 0.5...10V	P-10076	NO	manual
A77	76s	0.5...10V	U5	U5 0.5...10V	P-10077	NO	manual
A78	150s	2...10V	U5	U5 0.5...10V	P-10078	NO	manual
A79	150s	0.5...10V	U5	U5 0.5...5V	P-10079	NO	manual
A80	150s	0.5...3.5	U5	U5 2...10V	P-10080	NO	manual
A81	150s	4.5...10	U5	U5 2...10V	P-10081	NO	manual
A82	150s	3...10V	U5	U5 2...10V	P-10082	NO	manual
A83	150s	5...15V	U5	U5 2...10V	P-10083	NO	manual
A84	150s	13...20V	U5	U5 2...10V	P-10084	NO	manual
A85	150s	2...10V	U5	U5 2...10V	P-10085	NO	manual
A86	150s	5...10.5	U5	U5 2...10V	P-10086	NO	manual
A88	150s	2...10V	U5	U5 2...10V	P-10088	NO	manual
A89	150s	12.5...22V	U5	U5 2...10V	P-10089	NO	manual
A90	150s	2...5V	U5	U5 2...5V	P-10090	NO	manual
A91	95s	2...10V	U5	U5 2...10V	P-10091	NO	manual
A92	150s	0.5...15V	U5	U5 0.5...10V	P-10092	NO	manual
A93	150s	2...10V	U5	U5 2...10V	P-10093	NO	manual
A94	85s	2...10V	U5	U5 2...10V	P-10094	NO	manual
A95	150s	0.5...5V	U5	U5 0.5...5V	P-10095	NO	manual
A96	150s	0.5...10V	U5	U5 2...10V	P-10096	NO	manual
A97	150s	5.25...7.25	U5	U5 2...10V	P-10097	NO	manual
A98	150s	2...10V	U5	U5 2...10V	P-10098	NO	auto-synch.
A99	150s	2...10V	U5	U5 2...10V	P-10099	NO	manual
AA0	150s	0.5...12.85	U5	U5 2...10V	P-10100	NO	manual
AA1	150s	3...15V	U5	U5 2...10V	P-10101	NO	manual
AA2	150s	0.5...14V	U5	U5 2...10V	P-10102	NO	manual
AA4	150s	0.5...22V	U5	U5 2...10V	P-10104	NO	manual
AA5	150s	0.5...4V	U5	U5 0.5...5V	P-10105	NO	manual
AA6	150s	6...10V	U5	U5 0.5...5V	P-10106	NO	manual
AA7	150s	2...7V	U5	U5 2...10V	P-10107	NO	manual
AA8	150s	4...10V	U5	U5 2...10V	P-10108	NO	manual
AA9					P-10109		
AAA	150s	2...22V	U5	U5 2...10V	P-10110	NO	manual
AAB	150s	0.5...20V	U5	U5 0.5...10V	P-10111	NO	manual
AAC	150s	0.5...29V	U5	U5 2...10V	P-10112	NO	manual
AAD	100s	0.5...4.5V	U5	U5 0.5...4.5V	P-10113	NO	manual
AAE	100s	5.5...10V	U5	U5 5.5...10V	P-10114	NO	manual
AAF	150s	0.5...28V	U5	U5 2...10V	P-10115	NO	manual
AAG	75s	0.5...10V	U5	U5 2...10V	P-10116	NO	auto-adapt.
AAH	150s	0.5...10V	U5	U5 4...5V	P-10117	NO	auto-adapt.
AAJ	100s	2...6V	U5	U5 2...10V	P-10118	NO	auto-adapt.
AAK	100s	6...10V	U5	U5 2...10V	P-10119	NO	manual
AAL	150s	8...20V	U5	U5 2...10V	P-10120	NO	manual
AAAM	120s	0.5...10V	U5	U5 2...10V	P-10121	NO	auto-synch.
AAN	100s	0.5...10V	U5	U5 2...10V	P-10122	NO	manual
AAP	150s	2...10V	U5	U5 2...10V	P-10123	NO	manual
AAR	150s	2...10V	U5	U5 2...10V	P-10124	NO	auto-adapt.
AAS	150s	2...10V	U5	U5 2...10V	P-10125	NO	manual
AAT	20s	2...10V	U5	U5 2...10V	---	NO	manual
AAU	100s	6...9V	U5	U5 2...10V	---	NO	manual
AAV	150s	1.2...6V	U5	U5 2...10V	---	NO	manual
AAW							
AAX	35s	2...10V	U5	U5 2...10V	P-10130	NO	manual
AC0	45s	2...10V	U5	U5 2...10V	P-10131	NO	manual

M40035 - 05/10 - Subject to change. © Belimo Aircontrols (USA), Inc.

Programmable Code	Running Time	Control Range	Feedback	Feedback Range	Obsolete Code	MP Bus Logo	Adaption
AC1	90s	2...10V	U5	U5 2...10V	P-10132	NO	manual
AC2	150s	0.5...10V	U5	U5 0.5...10V	---	NO	manual
000	150s	2...10V	U5	U5 2...10V	---	YES	manual
AC4	150s	0.5...10V	U5	U5 0.5...10V	---	YES	manual
AC5	75s	2...10V	U5	U5 2...10V	P-10133	NO	manual
AC6	450s	2...10V	U5	U5 2...10V	P-10134	NO	manual
AC7	150s	...	U5	U5 2...10V	---	NO	manual
AC8	35s	0.5...10V	U5	U5 0.5...10V	---	NO	manual
AC9	45s	0.5...10V	U5	U5 0.5...10V	---	NO	manual
ACA	90s	0.5...10V	U5	U5 0.5...10V	---	NO	manual
ACX	150s	2...10V	U5	U5 0.5...10V	---	NO	manual
AD0	100s	0.5...5V	U5	U5 2...10V	P-10135	NO	manual
AD1	100s	5...10V	U5	U5 2...10V	P-10136	NO	manual
AD2	90s	2...10V	U5	U5 2...10V	---	NO	auto-adapt.
AD3	35s	2...10V	U5	U5 2...10V	---	NO	auto-adapt.
AD4	150s	2...10V	U5	U5 2...10V	---	NO	manual
AD5	100s	2...5V	U5	U5 2...10V	P-10137	NO	manual
AD6							
AD7	100s	0.5...5V	U5	U5 2...10V	P-10140	NO	manual
AD8							
AD9							
ADA	PICCV ONLY	0.5...10V	U5	U5 0.5...10V	---	NO	manual
ADC							
ADD	150s	9...13V	U5	U5 2...10V	---	NO	manual
ADE							
ADF							
ADG							
ADH							
ADJ							
ADK							
ADL							
ADM							
ADN							
ADP							
ADR							
ADS							
ADT							
ADU							
ADV							
ADW	70s	2...10V	US	US 2...10V	---	NO	manual
ADX	40s	2...10V	US	US 2...10V	---	NO	manual
AE0							
AE1							
AE2							
AE3							

IM40035 - 05/10 - Subject to change. © Belimo Aircontrols (USA), Inc.



Programmable Code	Running Time	Control Range	Feedback	Feedback Range	Obsolete Code	MP Bus Logo	Adaption
AE4							
AE5							
AE6							
AE7							
AE8							
AE9							
AEA	120s	0.5...10V	U5	U5 0.5...10V	---	NO	manual
AEC	75s	0.5...10V	U5	U5 0.5...10V	---	NO	manual
AED	300s	0.5...10V	U5	U5 0.5...10V	---	NO	manual
AEE	450s	0.5...10V	U5	U5 0.5...10V	---	NO	manual
AEF							
AEG							
AEH							
AEJ							
AEK							
AEL							
AEM							
AEN							
AEP							
AER							
AES							
AET							
AEU							
AEV							
AEW							
AEX							
AFO							

Programmable Code	Running Time	Control Range	Feedback	Feedback Range	Obsolete Code	MP Bus Logo	Adaption
R01	150s	0...135 Ohm	U5	U5 2...10V	P-16001	NO	manual
R02	150s	0...135 Ohm	U5	U5 0.5...10V	P-16002	NO	manual
R03	150s	0...135 Ohm	U5	U5 0.5...5V	P-16003	NO	manual
R04	75s	0...135 Ohm	U5	U5 2...10V	P-16004	NO	manual
R05	100s	0...135 Ohm	U5	U5 0.5...10V	P-16028	NO	manual
R06					P-16029		
R07	35s	0...135 Ohm	U5	U5 2...10V		NO	manual
R08	45s	0...135 Ohm	U5	U5 2...10V		NO	manual
R09	90s	0...135 Ohm	U5	U5 2...10V		NO	manual
R0A	37s	0...135 Ohm	U5	U5 2...10V		NO	manual
R0C							
R0D							
R0E							
R0F							
R0G							
R0H							
R0J							
R0K							
R0L							
R0M							
R0N							
R0P							
R0R							
R0S							
R0T							
R0U							
R0V							
R0W							
R0X							
R10							
R11							

IM40035 - 05/10 - Subject to change. © Belimo Aircontrols (USA), Inc.

Programmable Code	Running Time	Control Range	Feedback	Feedback Range	Obsolete Code	MP Bus Logo	Adaption
W01	150s	0.59...2.93s	U5	U5 2...10V	P-20001	NO	manual
W02	150s	0.02...5s	U5	U5 2...10V	P-20002	NO	manual
W03	150s	0.1...25.5s	U5	U5 2...10V	P-20003	NO	manual
W04	150s	0.1...25.6s	U5	U5 2...10V	P-20004	NO	manual
W05	150s	0.1...5.2s	U5	U5 0.5...5V	P-20005	NO	manual
W06	150s	0.59...2.93s	U5	U5 0.5...10V	P-20006	NO	manual
W07	150s	0.02...5s	U5	U5 0.5...5V	P-20007	NO	manual
W08	150s	0.1...10s	U5	U5 2...10V	P-20008	NO	manual
W09	150s	1...11s	U5	U5 2...10V	P-20009	NO	manual
W10	150s	0.02...5s	U5	U5 2...10V	P-20010	NO	manual
W11	150s	0.02...5.6s	U5	U5 2...10V	P-20011	NO	manual
W12	150s	0.5...25.5s	U5	U5 2...10V	P-20012	NO	manual
W13	150s	0.5...2.93s	U5	U5 2...10V	P-20013	NO	manual
W14	150s	0.1...10s	U5	U5 2...10V	P-20014	NO	manual
W15	150s	1...11s	U5	U5 2...10V	P-20015	NO	manual
W16	150s	0.02...5s	U5	U5 2...10V	P-20016	NO	auto-adapt.
W17	150s	0.02...5.6s	U5	U5 2...10V	P-20017	NO	auto-adapt.
W18	150s	0.1...25.5s	U5	U5 2...10V	P-20018	NO	auto-adapt.
W19	150s	0.02...2.5s	U5	U5 2...10V	P-20019	NO	manual
W20	150s	2.7...5s	U5	U5 2...10V	P-20020	NO	manual
W21	150s	0.1...5.2s	U5	U5 2...10V	P-20021	NO	manual
W22	150s	0.1...12.85s	U5	U5 2...10V	P-20022	NO	manual
W23	150s	5.1...10.1s	U5	U5 2...10V	P-20023	NO	manual
W24	150s	0.59...1.76s	U5	U5 2...10V	P-20024	NO	manual
W25	150s	1.76...2.93s	U5	U5 2...10V	P-20025	NO	manual
W26	150s	0.02...12s	U5	U5 2...10V	P-20026	NO	manual
W27	150s	0.02...14s	U5	U5 2...10V	P-20027	NO	manual
W28	150s	12.5...22s	U5	U5 2...10V	P-20028	NO	manual
W29	150s	0.5...12.85s	U5	U5 2...10V	P-20029	NO	manual
W30	150s	0.1...24s	U5	U5 2...10V	P-20030	NO	manual
W31	100s	0.02...5s	U5	U5 Ω2...10V	P-20031	NO	off
W32	100s	0.1...25.5	U5	U5 2...10V	P-20032	NO	off
W33	150s	0.2...25.5	U5	U5 2...10V	P-20033	NO	manual
W34	100s	0.59...2.93s	U5	U5 2...10V	P-20034	NO	off
W35	150s	5.5...9.5s	U5	U5 2...10V	P-20035	NO	manual
W36	150s	0.5...4.5s	U5	U5 2...10V	P-20036	NO	manual
W37	150s	0.1...5.2s	U5	U5 0.5...10V	P-20037	NO	manual
W38	150s	0.02...6s	U5	U5 2...10V	P-20038	NO	manual
W39	150s	0.59...2.93s	U5	U5 2...10V	P-20039	NO	auto-adapt.
W3A	150s	0.5...5.0s	U5	U5 2...10V	P-20040	NO	auto-adapt.
W3C	150s	0.1...25.5s	U5	U5 2...10V	---	NO	manual
W3D	150s	0.2...5.2s	U5	U5 2...10V	P-20041	NO	manual
W3E							
W3F							
W3G							
W3H							
W3J							
W3K							
W3L							
W3M							
W3N							
W3P							
W3R							
W3S							
W3T							
W3U							
W3V							
W3W							
W3X							
W40							
W41							

M40035 - 05/10 - Subject to change. © Belimo Aircontrols (USA), Inc.

Programmable Code	Running Time	Control Range	Feedback	Feedback Range	Obsolete Code	MP Bus Logo	Adaption
F01	150s	---	U5	U5 2...10V	P-30001	NO	manual
F02	150s	---	U5	U5 0.5...10V	P-30002	NO	manual
F03	100s	---	U5	U5 2...10V	P-30003	NO	manual
F04	100s	---	U5	U5 0.5...5V	P-30004	NO	manual
F05	100s	---	U5	U5 0.5...10V	P-30005	NO	manual
F06	150s	---	U5	U5 0.5...5V	P-30006	NO	manual
F07	300s	---	U5	U5 2...10V	P-30007	NO	manual
F08	75s	---	U5	U5 2...10V	P-30008	NO	manual
F09	85s	---	U5	U5 2...10V	P-30009	NO	manual
F10	150s	---	U5	U5 0.5...6V	P-30010	NO	manual
F11	75s	---	U5	U5 0.5...5V	P-30011	NO	manual
F13	120s	---	U5	U5 0.5...10V	P-30013	NO	manual
F14	90s	---	U5	U5 2...10V	P-30014	NO	manual
F15	150s	---	U5	U5 0.5...4.5V	P-30015	NO	manual
F16	150s	---	U5	U5 1...5V	P-30016	NO	manual
F17	90s	---	U5	U5 1...10V	P-30017	NO	manual
F18	60s	---	U5	U5 2...10V	---	NO	manual
F19	45s	---	U5	U5 2...10V	---	NO	manual
F1A	35s	---	U5	U5 2...10V	---	NO	manual
F1C							
F1D							
F1E							
F1F							
F1G	120s	---	U5	U5 2...10V	---	NO	manual
F1H	450s	---	U5	U5 2...10V	---	NO	manual
F1J							
F1K							
F1L							
F1M							
F1N							
F1P							
F1R							
F1S							
F1T							
F1U							
F1V							
F1W							
F1X							
F20							
F21							

Programmable Code	Running Time	Control Range	Feedback	Feedback Range	Obsolete Code	MP Bus Logo	Adaption
J01	75s	---	U5	U5 2...10V	P-40001	NO	manual
J02	150s	---	U5	U5 2...10V	P-40002	NO	manual
J03	75s	---	U5	U5 2...10V	P-40003	NO	manual
J04	100s	---	U5	U5 0.5...5V	P-40004	NO	manual
J05	100s	---	U5	U5 0.5...10V	P-40005	NO	manual
J06	120s	---	U5	U5 2...10V	P-40006	NO	manual
J07	45s	---	U5	U5 2...10V	P-40007	NO	manual
J08	200s	---	U5	U5 2...10V	P-40008	NO	manual
J09	120s	---	U5	U5 0.5...10V	P-40009	NO	manual
J10	300s	---	U5	U5 2...10V	P-40010	NO	manual
J11	150s	---	U5	U5 0.5...10V	P-40011	NO	manual
J13	100s	---	U5	U5 0.5...5V	P-40012	NO	manual (off)
J14							
J15							
J16							
J17							
J18							
J19							
J1A							
J1C							
J1D							
J1E							
J1F							
J1G							
J1H							
J1J							
J1K							
J1L							
J1M							
J1N							
J1P							
J1R							
J1S							
J1T							
J1U							
J1V							
J1W							
J1X							
J20							
J21							

MM40035 - 05/10 - Subject to change. © Belimo Aircontrols (USA), Inc.

Programmable Code	Running Time	Control Range	Feedback	Feedback Range	Obsolete Code	MP Bus Logo	Adaption
T01	2.5s	2...10V	U5	U5 2...10V	---	NO	manual
T02	4s	2...10V	U5	U5 2...10V	---	NO	manual
T03	7s	2...10V	U5	U5 2...10V	---	NO	manual
T04	10s	2...10V	U5	U5 2...10V	---	NO	manual
T05	15s	2...10V	U5	U5 2...10V	---	NO	manual
T06	20s	2...10V	U5	U5 2...10V	---	NO	manual
T07	2.5s	0.5...10V	U5	U5 0.5...10V	---	NO	manual
T08	4s	0.5...10V	U5	U5 0.5...10V	---	NO	manual
T09	7s	0.5...10V	U5	U5 0.5...10V	---	NO	manual
T0A	10s	0.5...10V	U5	U5 0.5...10V	---	NO	manual
T0C	15s	0.5...10V	U5	U5 0.5...10V	---	NO	manual
T0D	20s	0.5...10V	U5	U5 0.5...10V	---	NO	manual
T0E							
T0F							
T0G							
T0H							
T0J							
T0K							
T0L							
T0M							
T0N							
T0P							
T0R							
T0S							
T0T							
T0U							
T0V							
T0W							
T0X							
T10							
T11							

Programmable Code	Running Time	Control Range	Feedback	Feedback Range	Obsolete Code	MP Bus Logo	Adaption
S01	150s	Phasecut	U5	U5 2...10V		NO	manual
S02	35s	Phasecut	U5	U5 2...10V		NO	manual
S03	45s	Phasecut	U5	U5 2...10V		NO	manual
S04	90s	Phasecut	U5	U5 2...10V		NO	manual
S05							
S06	150s	4...20mA	U5	U5 2...10V		NO	manual
S07							
S08	45s	4...20mA	U5	U5 2...10V		NO	manual
S09	90s	4...20mA	U5	U5 2...10V		NO	manual
S0A							
S0C	75s	4...20mA	U5	U5 2...10V		NO	manual
S0D	75s	Phasecut	U5	U5 2...10V		NO	manual
S0E							
S0F							
S0G							
S0H							
S0J							
S0K							
S0L							
S0M							
S0N							
S0P							
S0R							
S0S							
S0T							
S0U							
S0V							
S0W							
S0X							
S10							
S11							

MM40035 - 05/10 - Subject to change. © Belimo Aircontrols (USA), Inc.

Programmable Code	Running Time	Control Range	Feedback	Feedback Range	Obsolete Code	MP Bus Logo	Adaption
N01	150s	2...10V	U5	U5 2...10V	V-10001	NO	manual
N02	150s	0.5...10V	U5	U5 0.5...10V	V-10002	NO	manual
N03	150s	2...10V	U5	U5 0.5...5V	V-10003	NO	manual
N04	150s	4...7V	U5	U5 2...10V	V-10004	NO	manual
N05	150s	6...9V	U5	U5 2...10V	V-10005	NO	manual
N06	150s	10.5...13.5V	U5	U5 2...10V	V-10006	NO	manual
N07	150s	0.5...5V	U5	U5 2...10V	V-10007	NO	manual
N08	150s	0.5...5V	U5	U5 0.5...10V	V-10008	NO	manual
N09	150s	5...10V	U5	U5 2...10V	V-10009	NO	manual
N10	150s	5...10V	U5	U5 0.5...10V	V-10010	NO	manual
N11	150s	0.5...5V	U5	U5 0.5...5V	V-10011	NO	manual
N12	150s	0.5...5V	U5	U5 0.5...2.5V	V-10012	NO	manual
N13	150s	0.5...10V	U5	U5 2...10V	V-10013	NO	manual
N14	150s	0.5...10V	U5	U5 0.5...2.5V	V-10014	NO	manual
N15	150s	2...5V	U5	U5 2...10V	V-10015	NO	manual
N16	150s	2...6V	U5	U5 2...10V	V-10016	NO	manual
N17	150s	6...10V	U5	U5 2...10V	V-10017	NO	manual
N18	150s	14...17V	U5	U5 2...10V	V-10018	NO	manual
N19	100s	2...10V	U5	U5 2...10V	V-10019	NO	manual
N1A	150s	5.1...10V	U5	U5 5.1...10V	V-10023	NO	manual
N1C	75s	2...10V	U5	U5 2...10V	V-10025	NO	manual
N1D	150s	5...9V	U5	U5 2...10V	V-10027	NO	manual
N1E	100s	0.5...10V	U5	U5 0.5...10V	V-10028	NO	manual
N1F	150s	3...6V	U5	U5 2...10V	V-10041	NO	manual
N1G	150s	0.5...2.5V	U5	U5 2...10V	V-10043	NO	manual
N1H	150s	7...10V	U5	U5 2...10V	V-10044	NO	manual
N1J	150s	0.5...20V	U5	U5 2...10V	V-10047	NO	manual
N1K	150s	0.5...4.5V	U5	U5 0.5...4.5V	V-10063	NO	manual
N1L	150s	5.5...10V	U5	U5 5.5...10V	V-10064	NO	manual
N1M	150s	2...15V	U5	U5 2...10V	V-10071	NO	manual
N1N	76s	0.5...10V	U5	U5 0.5...10V	V-10077	NO	manual
N1P	75s	2...6V	U5	U5 2...10V	V-10078	NO	manual
N1R	75s	6...10V	U5	U5 2...10V	V-10079	NO	manual
N1S	150s	3...7V	U5	U5 2...10V	V-10082	NO	manual
N1T	150s	0.59...2.93s	U5	U5 2...10V	V-20001	NO	manual
N1U	150s	0.02...5s	U5	U5 2...10V	V-20002	NO	manual
N1V	150s	0.1...25.5s	U5	U5 2...10V	V-20003	NO	manual
N1W	150s	0.1...25.6s	U5	U5 2...10V	V-20004	NO	manual
N1X	150s	0.1...5.2s	U5	U5 0.5...5V	V-20005	NO	manual
N20	150s	0.59...2.93s	U5	U5 0.5...5V	V-20006	NO	manual
N21	150s	0.02...5s	U5	U5 2...10V	V-20007	NO	manual
N22	150s	0.1...5.2s	U5	U5 2...10V	V-20021	NO	manual
N23	150s	0.5...4.5s	U5	U5 2...10V	V-20040	NO	manual
N24	150s	---	U5	U5 2...10V	V-30001	NO	manual
N25	150s	---	U5	U5 0.5...10V	V-30002	NO	manual
N26	150s	---	U5	U5 0.5...5V	V-30006	NO	manual
N27	75s	---	U5	U5 2...10V	V-30008	NO	manual
N28	75s	---	U5	U5 2...10V	V-40001	NO	manual
N29	150s	---	U5	U5 2...10V	V-40002	NO	manual
N30	100s	---	U5	U5 0.5...5V	V-40004	NO	manual
N3A	100s	---	U5	U5 0.5...10V	V-40005	NO	manual



Programmable Code	Loss of Control Signal	Input Signal	Feedback	Output Signal
ACE	stop	2...10V	U5	U5 2...10V
ACF	stop	0.5...10V	U5	U5 0.5...10V
ACG	stop	4...20mA	U5	U5 4...20mA
ACH	stop	4...20mA	U5	U5 2...10V
ACJ	open	2...10V	U5	U5 2...10V
ACK	open	0.5...10V	U5	U5 0.5...10V
ACL	open	4...20mA	U5	U5 4...20mA
ACM	open	4...20mA	U5	U5 2...10V
ACN	close	2...10V	U5	U5 2...10V
ACP	close	0.5...10V	U5	U5 0.5...10V
ACR	close	4...20mA	U5	U5 4...20mA
ACS	close	4...20mA	U5	U5 2...10V
W3E**	stop	0.02-5.00 seconds PWM	U5	U5 2...10V

Note: Runtime is fixed based on actuator model.

\*\*Available only on -24MFT models.





# PC-Tool Accessories

MA40035 - 05/10 - Subject to change. © Belimo Aircontrols (USA), Inc.



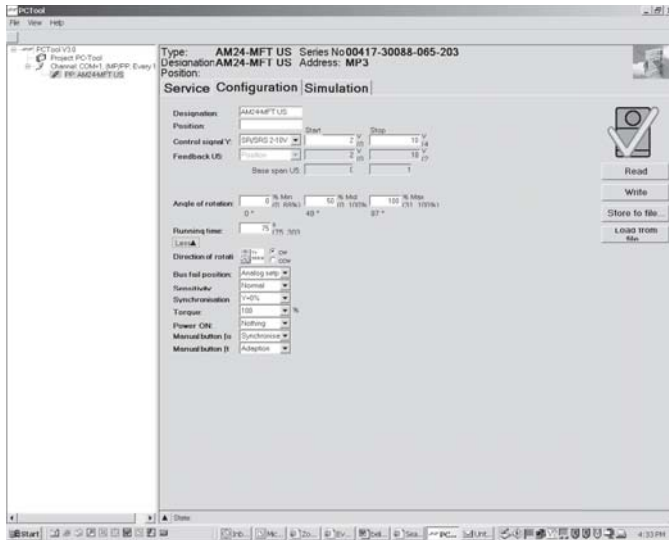

### Application

The Belimo PC-Tool software is a graphical user interface which allows the user to set, modify and read actuator characteristics.

The Belimo PC-Tool is an MFT support tool which is a practical solution for Controls distributors and Installation contractors.

#### The Controls Distributor can:

- Reduce inventory levels
- Optimize the flexible MFT product inventory
- Quickly program an MFT actuator
- Provide MFT custom retrofit solutions – same day
- Re-label the actuator with correct parameters

#### The Installation contractor or field technician can:

- Work with PCs having a dedicated hand held tool
- Connect and program actuators quickly on an as needed basis
- Get systems up and running faster for service replacement applications
- Optimize flexibility of MFT product inventory for replacement applications
- Program actuators to your company standard configuration

### Required Accessory

ZIP-RS232 US (required)

OR

ZIP-USB-MP (required)

AND

ZK Cable depending upon application (required)

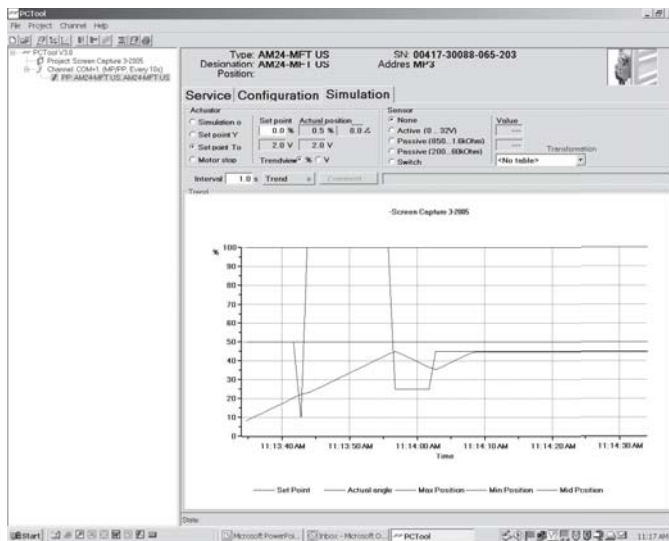

Technical Data	MFT-P US
Software version	3.X
Compatible Operating System	For Windows 2000/XP/Vista
System requirements	10 MB free hard disk space
Modules	MFT-PC
Language	English / German
CD contents	Set-up.exe (Installation tool) Software documentation (requires Adobe Acrobat Reader) Adobe Acrobat Reader
License	Not required

# ZIP-USB-MP US

For interfacing PC with...MFT US type actuators



Technical Data		ZIP-USB-MP US
Power Supply		AC 24 V 50/60 Hz, DC 24V
Nominal voltage range		AC 19.2...28.8 V, DC 21.6...28.8 V
Driver		For Windows 2000, XP or Vista (download at <a href="http://www.belimo.com">www.belimo.com</a> , call for link)
Connections	USB	USB 2.0, 1 m cable
	MP device	RJ11-socket
Electrical Safety		III safety extra-low voltage
Degree of protection		IP 20
Ambient temperature		0 to 122 °F
Storage temperature		-40 to 176 °F
Weight		<1.0 lb

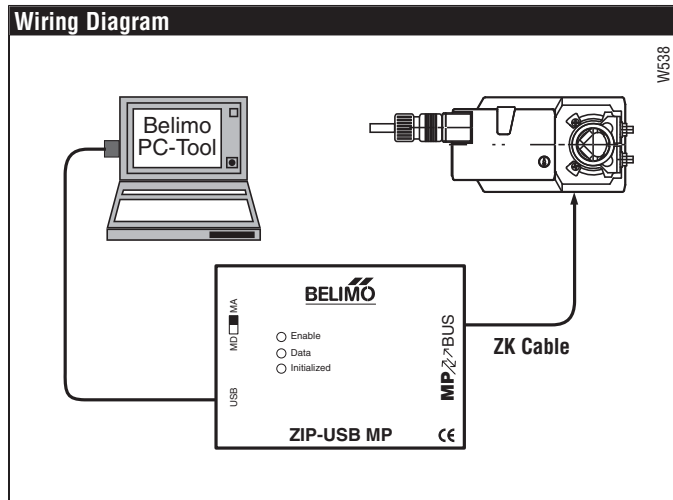

## Application

The ZIP-USB-MP is used with the Belimo PC-Tool software (MFT-P US) to interface all Multifunctional (...MFT US) type actuators via a USB port. Monitoring and parameterization of one MFT actuator is enabled.

The ZIP-USB-MP can also be used to interface the MFT actuators functionality via the UK24LON.

## Connection and Operation

### Power Supply

Power for the ZIP-USB-MP is supplied via the connected MFT actuator. The Actuator needs to be powered up in order for the unit to work.

### Connection and Indication

A PC is connected through its USB port and the associated ZK cable.

**NOTE:** A special driver found on the Belimo website is needed for the ZIP-USB-MP US to operate. Contact factory for details.

### Indication (See Accessories)

LED's show the status of the interface and the flow of data between the ZIP-USB MP and the MFT actuator/VAV controller.

#### LED *Initialized*

Data is transmitted from ZIP-USB-MP to actuator.

#### LED *Data*

- Data transmitted from actuator to ZIP-USB-MP.
- LED flashes synchronously when initialized if an actuator does not respond.

#### LED *Enable*

Steady light when the interface is active.

## Accessories

ZK1-GEN	Cable 16 ft, RJ11-plug
ZK2-GEN	Cable 16 ft, RJ11-plug, open wires
ZK3-GEN	Cable 16 ft, diagnostic socket, plug
ZK6-GEN	Use with SY actuator
ZKS-MP	Use with UK24LON US gateway
ZK1-VAV	Use with VAV actuators



ZIP-RS232

Technical data		ZIP-RS232 US
Supply voltage		24 VAC; Class II power supply
Power consumption		1 W / 1.5 VA (without actuator)
Electrical protection		MFT-XFMR is internally protected and automatically resets
Connections	Power supply	Stereo connector
	Actuator	Manual push button terminals
	MP-Bus	Orange male connector, ZKS-MP (Optional)
	RS232	PC cable, sub-D, 9 pin, female/female, included
Ambient temperature		0° to 122°F
Storage temperature		-40°F to 176°F
Electrical safety		Class III
Weight		<1.0 lb. (without actuator)

### Wiring Diagram

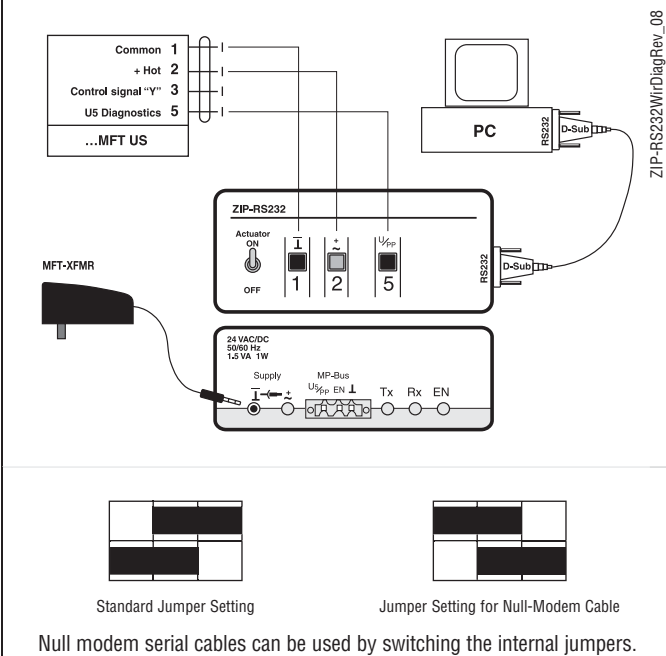

### Application

The ZIP-RS232 is used with the Belimo PC-Tool software (MFT-P US) to interface all Multifunctional (...MFT US) type actuators via an RS232 port. Monitoring and parameterization of one MFT actuator is enabled.

The ZIP-RS232 can also be used to interface the MFT actuators functionality via the UK24LON.

### Connection and Operation

#### Wiring Terminals

The ...MFT US actuator wires are connected to the terminals and correspond to the conductor wire designations. Some actuators are color coded and do not have numbered conductors. The following indications should be used:

- 1 = Black
- 2 = Red
- 5 = Orange (non-spring, TF)
- Green (LF)
- White (AF, NF)

#### Switch

The Actuator On/Off switch on the ZIP-RS232 applies 24 VAC power to the connected actuator. The ZIP-RS232 is powered when the MFT-XFMR is plugged into a power receptacle.

#### RS232 Connector

The ZIP-RS232 is connected via this RS232 connector to the PC with a standard female-female 9-pin sub-D cable, provided.

#### Power Supply

The MFT-XFMR accessory transformer is connected to the unit, and supplies 24 VAC power to the ZIP-RS232 and up to one connected actuator.

#### Power LED

A Green LED is lit when 24 VAC is supplied.

#### MP-Bus Connector

This connection is used only with the UK24LON or another MP-Master device.

#### Terminal Designations

U/PP: Data communications lead EN: Enabling signal for UK24LON

#### MP-Bus LED's

**Tx:** LED flashes when data flows from ZIP-RS232 to the ...MFT US actuator.

**Rx:** LED flashes when data flows from ...MFT US actuator to ZIP-RS232

**EN:** LED is lit constantly when RS232 device is connected.  
(E.g. PC is connected to ZIP-RS232)

### Accessories

**MFT-XFMR** Power transformer

**ZKS-MP** MP-bus cable for use with UK24LON

# MFT Cables

For Interfacing PC with...MFT US Type Actuators



## ZK1-GEN

Cable for use with ZIP USB-MP or ZIP-RS232 to connect new generation non-spring return actuators via diagnostic/programming socket

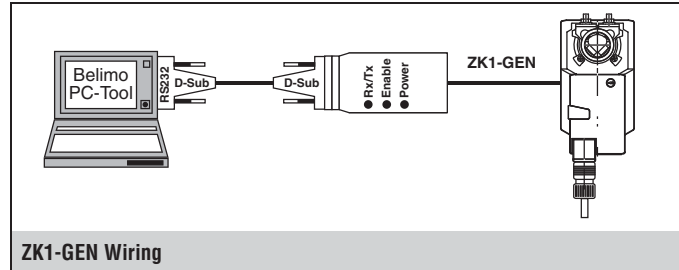

## ZK2-GEN

Cable to connect ZIP-RS232 with spring and non-spring return actuators not equipped with diagnostic/programming socket

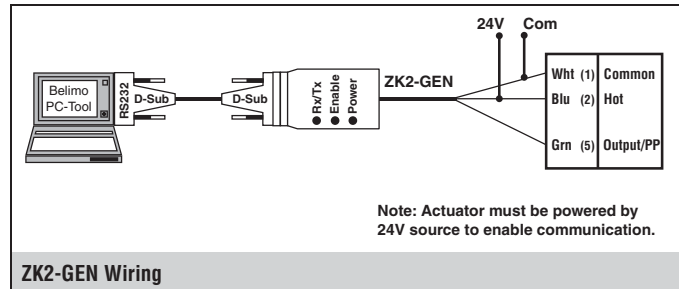

## ZK3-GEN

Cable to connect ZIP-RS232 or UK24LON US to new generation non-spring return actuator via diagnostic/programming socket

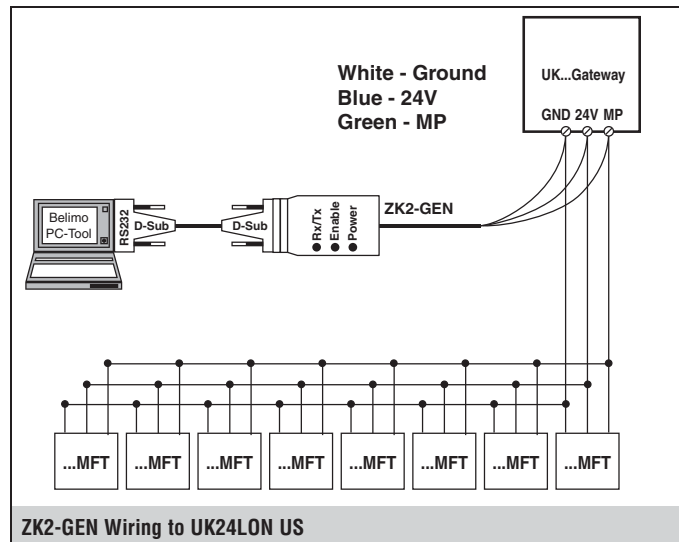

## ZK6-GEN

Cable to connect to ZIP USB-MP

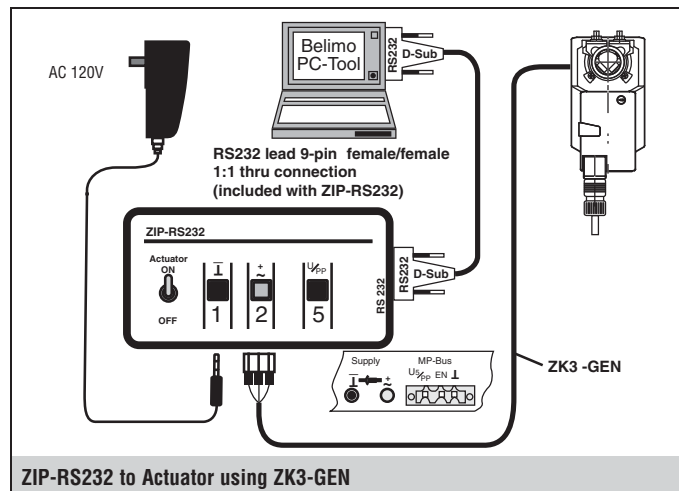

IM40035 - 05/10 - Subject to change. © Belimo Aircontrols (USA), Inc.



# PC-Tool User Manual

M40035 - 05/10 - Subject to change. © Belimo Aircontrols (USA), Inc.

This page intentionally left blank.

# Table of Contents

<b>1</b>	<b>Basics</b> .....	<b>1-1</b>
1.1	Introduction .....	1-1
1.2	General structure of the user software .....	1-2
<b>2</b>	<b>Getting started with PC-Tool</b> .....	<b>1-4</b>
2.1	Connecting the computer with the actuators .....	1-4
2.1.1	Driver Installation .....	1-9
2.1.2	Checking .....	1-13
2.2	Starting the program .....	1-15
2.3	Adapting PC-Tool options .....	1-15
2.4	Creating a new project .....	1-16
2.5	Setting up the program .....	1-16
2.6	Displaying actuator parameters .....	1-17
2.7	Further actions .....	1-17
<b>3</b>	<b>Basic functions</b> .....	<b>1-18</b>
3.1	Program start .....	1-18
3.2	Projects .....	1-19
3.2.1	Project data .....	1-19
3.2.2	Creating a new project .....	1-19
3.2.3	Opening a project .....	1-19
3.2.4	Changing project data .....	1-19
3.2.5	Exporting a project .....	1-20
3.2.6	Copying a project .....	1-20
3.2.7	Deleting a project .....	1-20
3.3	MP-Channel .....	1-20
3.3.1	Serial interface .....	1-20
3.3.2	Bus scan .....	1-21
3.4	Setting the bus address .....	1-22
3.4.1	Series addressing of actuators .....	1-23
3.4.2	Addressing with known serial numbers .....	1-24
3.4.3	Resetting actuator addresses .....	1-24
3.4.4	Addressing a single actuator .....	1-25
3.5	Selecting a module .....	1-26
3.6	Actuator parameters .....	1-27
3.6.1	Displaying actuator parameters .....	1-27
3.6.2	Printing out actuator parameters .....	1-27
3.6.3	Deleting maintenance/error messages .....	1-27

3.7	Configuring an actuator.....	1-29
3.7.1	Saving a parameter file .....	1-30
3.7.2	Loading a parameter file .....	1-30
3.7.3	Copying parameters.....	1-30
3.7.4	Load factory settings .....	1-30
3.8	Parameterizing limited lots.....	1-32
3.9	Printing labels .....	1-35
3.9.1	Setting up a configuration file .....	1-35
3.9.2	Printing labels.....	1-35
3.9.3	Printing labels offline.....	1-36
3.10	Transformation tables .....	1-36
3.11	Displaying recorded trend data .....	1-39
3.12	PC-Tool options .....	1-40
3.13	Log file.....	1-41
<b>4</b>	<b>Attachment .....</b>	<b>1-43</b>
4.1	Storage locations of files.....	1-43
4.1.1	Project data .....	1-43
4.1.2	Configuration files.....	1-43
4.2	Configuration files for printing labels .....	1-44
4.2.1	Storage location.....	1-44
4.2.2	Format .....	1-44
4.2.3	Boxes.....	1-45
4.2.4	Example of a label.....	1-47
4.3	Troubleshooting and error messages.....	1-48
4.3.1	General .....	1-48
4.3.2	Error messages .....	1-48
4.3.3	ISO 8859-1/ANSI character set.....	1-53
4.4	Typical wiring diagrams .....	1-54
4.4.1	Overview table .....	1-54
4.4.2	Typical wiring diagrams.....	1-55

# 1 Basics

---

## 1.1 Introduction

The user manual describes the functions of the Belimo PC-Tool. The Belimo PC-Tool is a PC-based tool for parameterizing Belimo MFT via bus.

This document is designed to present basic information. This booklet is based on PC-Tool 3.4. Later versions may contain more features.

## 1.2 General structure of the user software

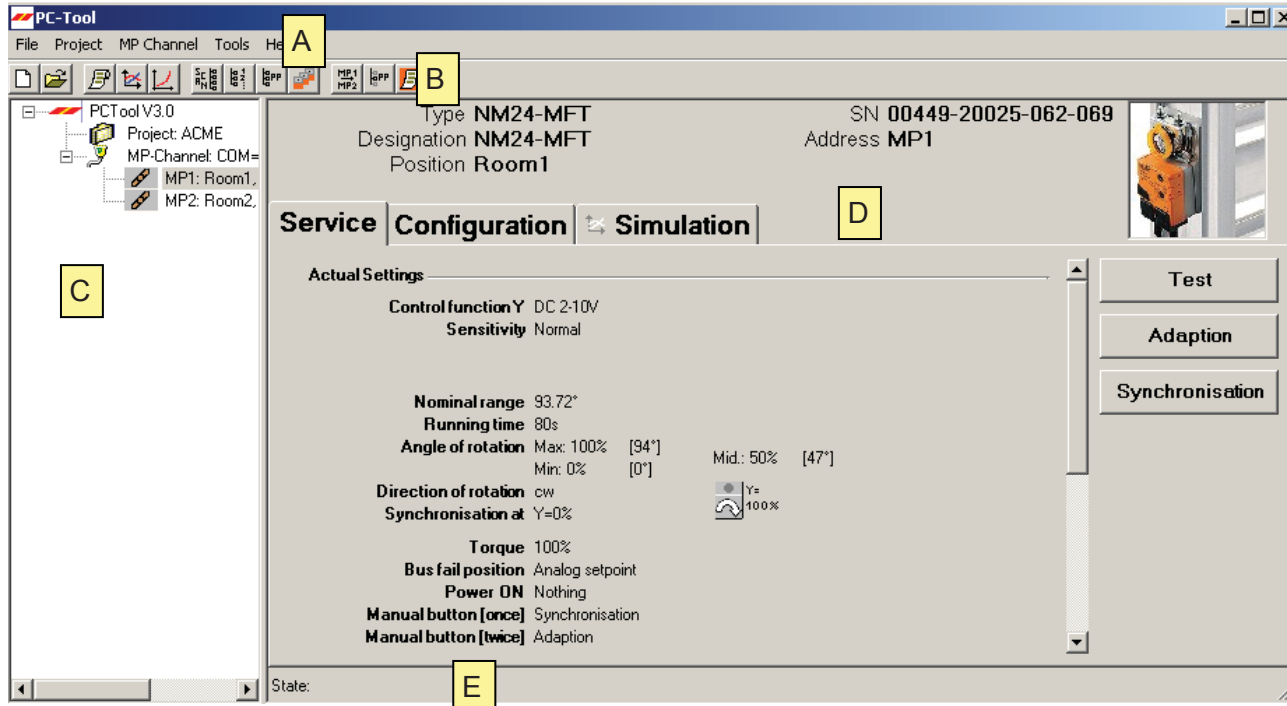

User interface PC-Tool



Menu bar [A] and toolbar [B] provide functions that affect the program as a whole. An explanatory text (tooltip) appears for each icon in the toolbar when you position the mouse pointer on it.

The MP-Channels and actuators belonging to the project are displayed in the outline bar [C] in the form of a tree (as in the Explorer). The object to be worked on is marked here. Depending on the selected object, pop-up menus offer corresponding functions at a click of the right mouse button.

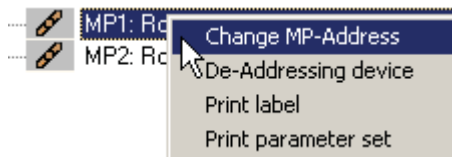

Pop-up menu after clicking the right mouse button

The detail area [D] contains all the detailed information on the highlighted actuator. The values that are displayed and changed in this area are grouped as needed and distributed over several index tabs.

The status bar [E] at the lower margin shows the current status of the connected device (e.g.: the actuator is carrying out a synchronization or adaptation.)

Missing or invalid entries are indicated by a flashing exclamation mark. If you move the mouse pointer to the exclamation mark, an explanatory text (tooltip) appears.

Project:   This field is required!



Inactive commands are displayed in gray letters (or as gray icons) according to the Windows standard.

Texts in boxes with a black font on a gray background cannot be changed. You can mark the contents with the mouse, however, and copy them into the clipboard with CTRL+C, for example.

Messsignal U5 variabel

## 2 Getting started with PC-Tool

### 2.1 Connecting the computer with the actuators

There are two ways to connect the computer (PC-Tool) to the actuators, via the ZIP-RS232 or by the ZIP-USB-MP US. If the ZIP-RS232 is going to be used, follow the wiring diagram that works best for your situation.



ZIP-RS232 via direct connection to MFT actuator.

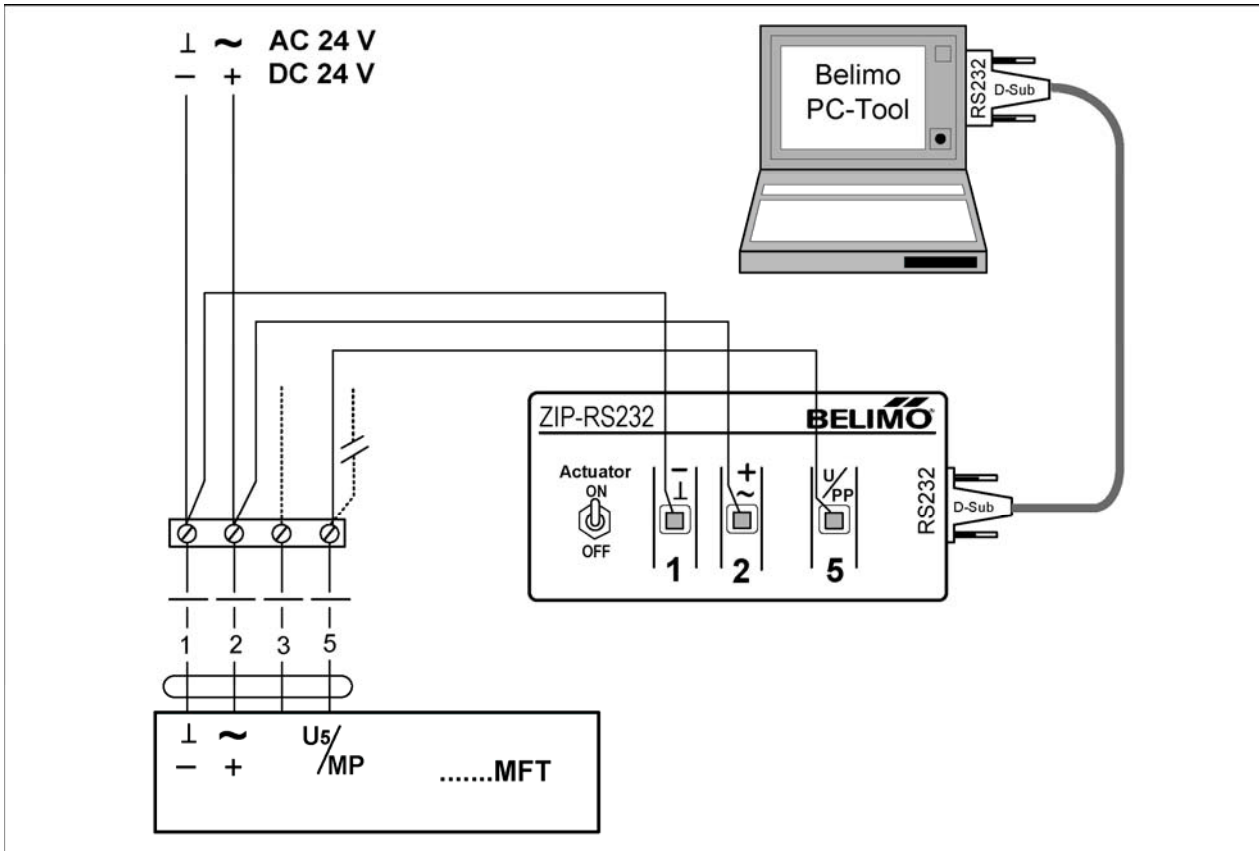

IM40035 - 05/10 - Subject to change. © Belimo Aircontrols (USA), Inc.



**ZIP-RS232 via ZK3-GEN to Belimo actuator.**

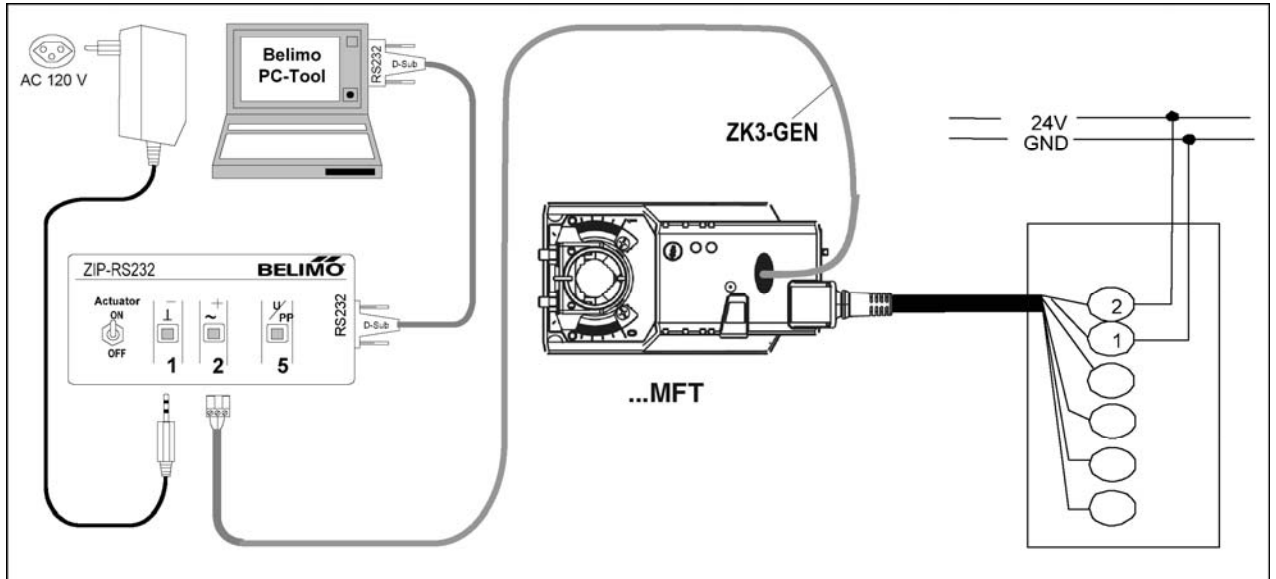

**ZIP-RS232 via ZK5-GEN to Belimo actuator.**

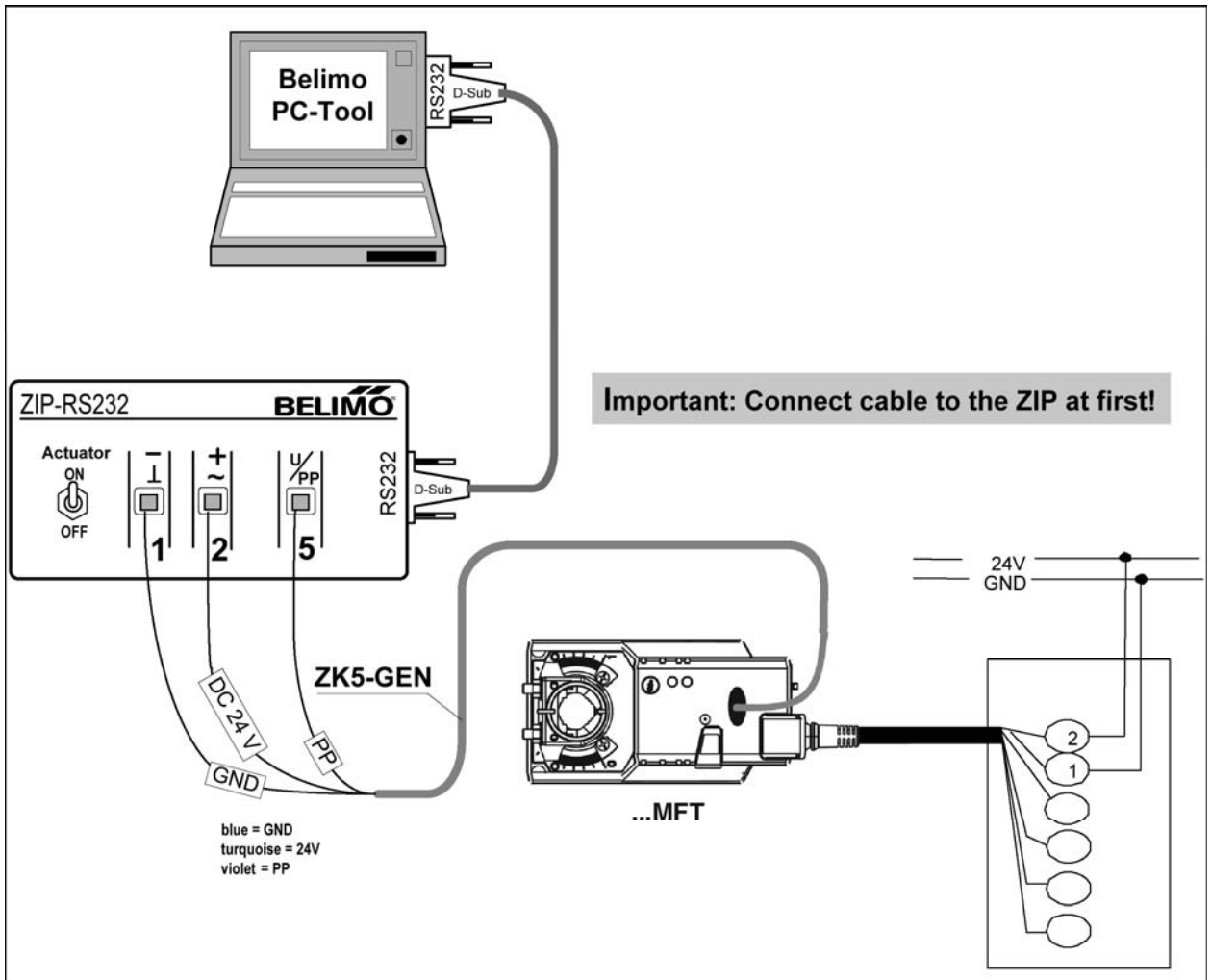

M40035 - 05/10 - Subject to change. © Belimo Aircontrols (USA), Inc.

ZIP-RS232 via direct connection to LON actuator.

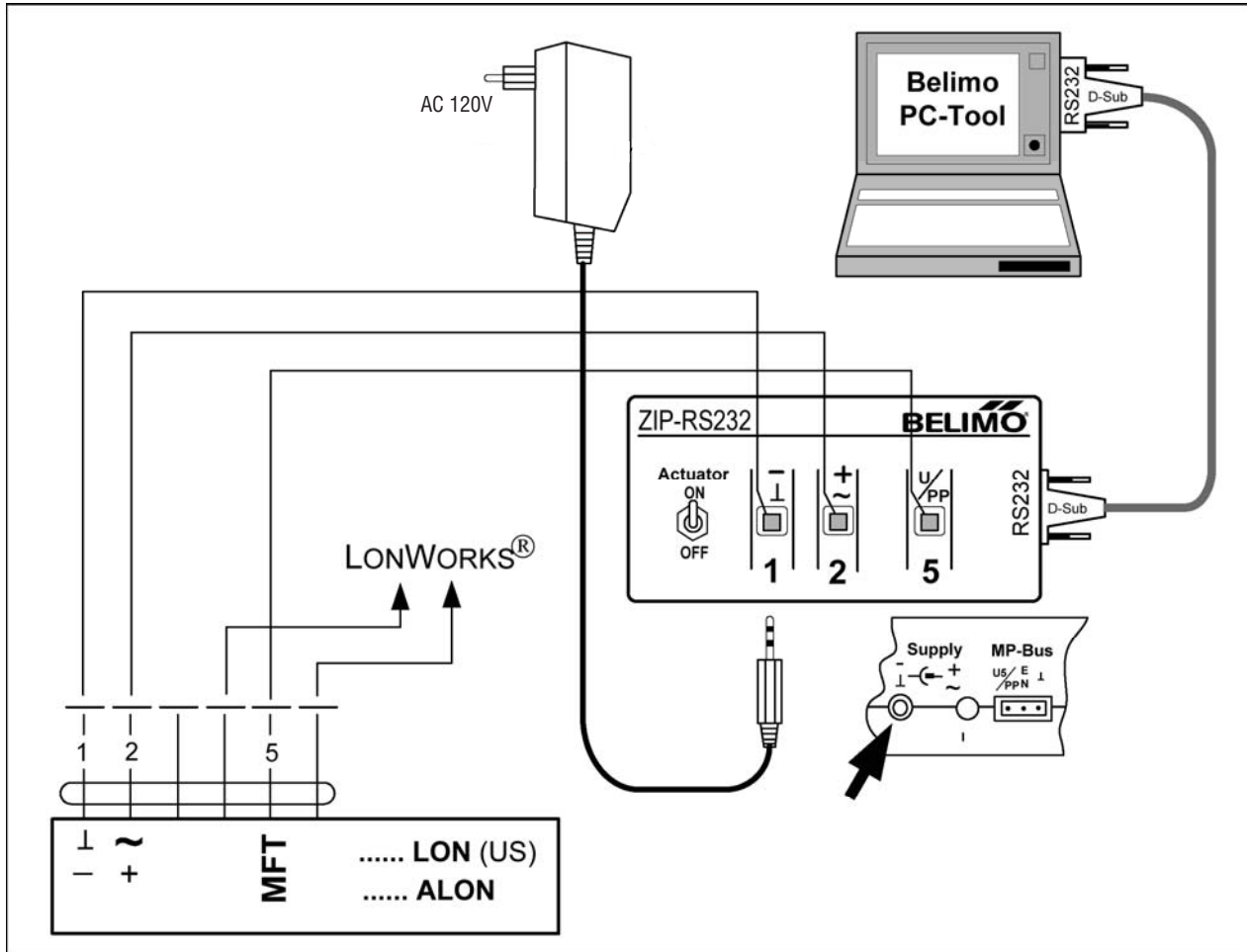

IM40035 - 05/10 - Subject to change. © Belimo Aircontrols (USA), Inc.

If the ZIP-USB-MP is going to be used, follow the directions to load the ZIP-USB-MP software and driver. Please note the ZIP-USB-MP is paired with the computer, if you move the ZIP-USB-MP the software and driver must be installed on the new computer.

**ZIP-USB-MP via ZK1-GEN to a Belimo actuator.**

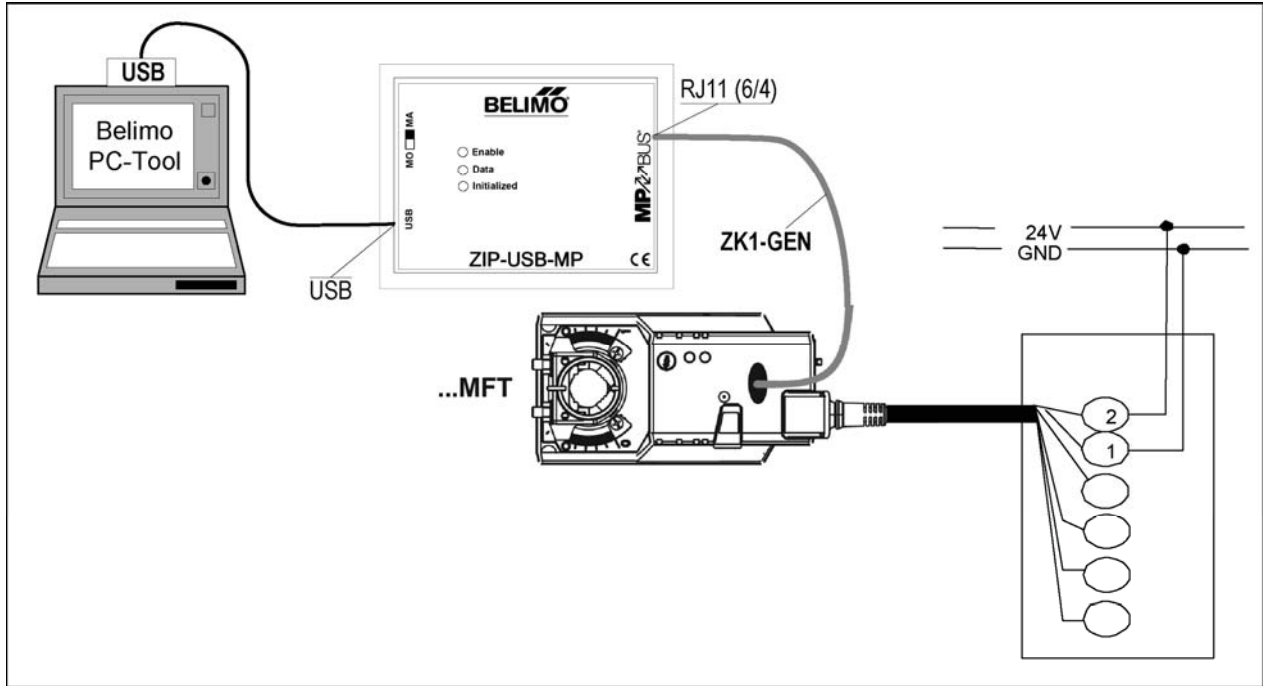

**ZIP-USB-MP via ZK2-GEN to a Belimo actuator.**

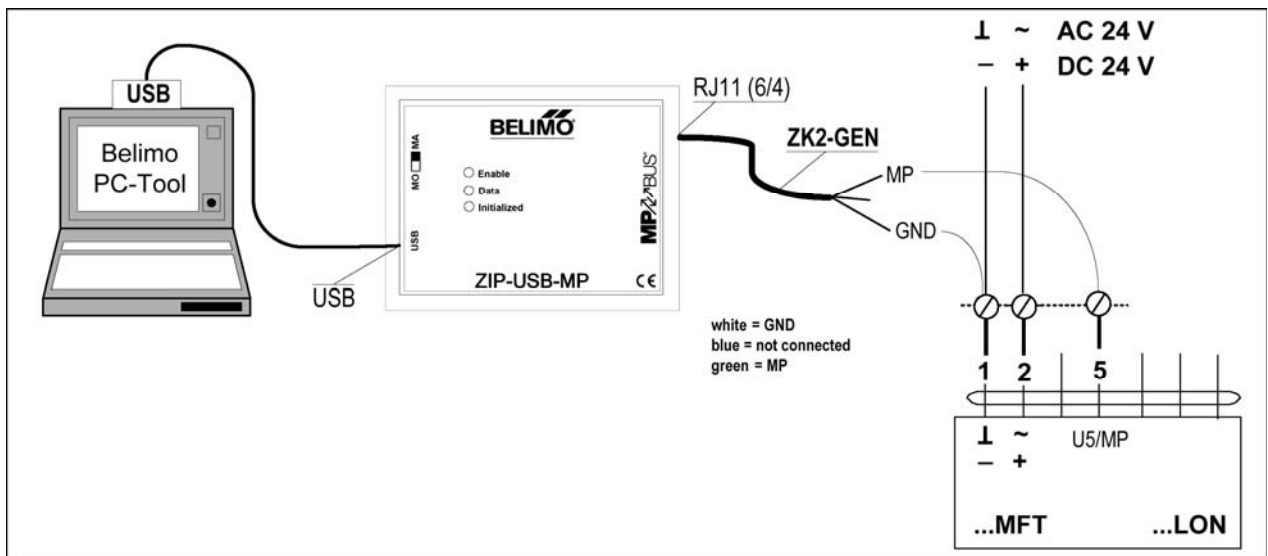

M40035 - 05/10 - Subject to change. © Belimo Aircontrols (USA), Inc.

ZIP-USB-MP via ZK1-GEN to a Belimo actuator.

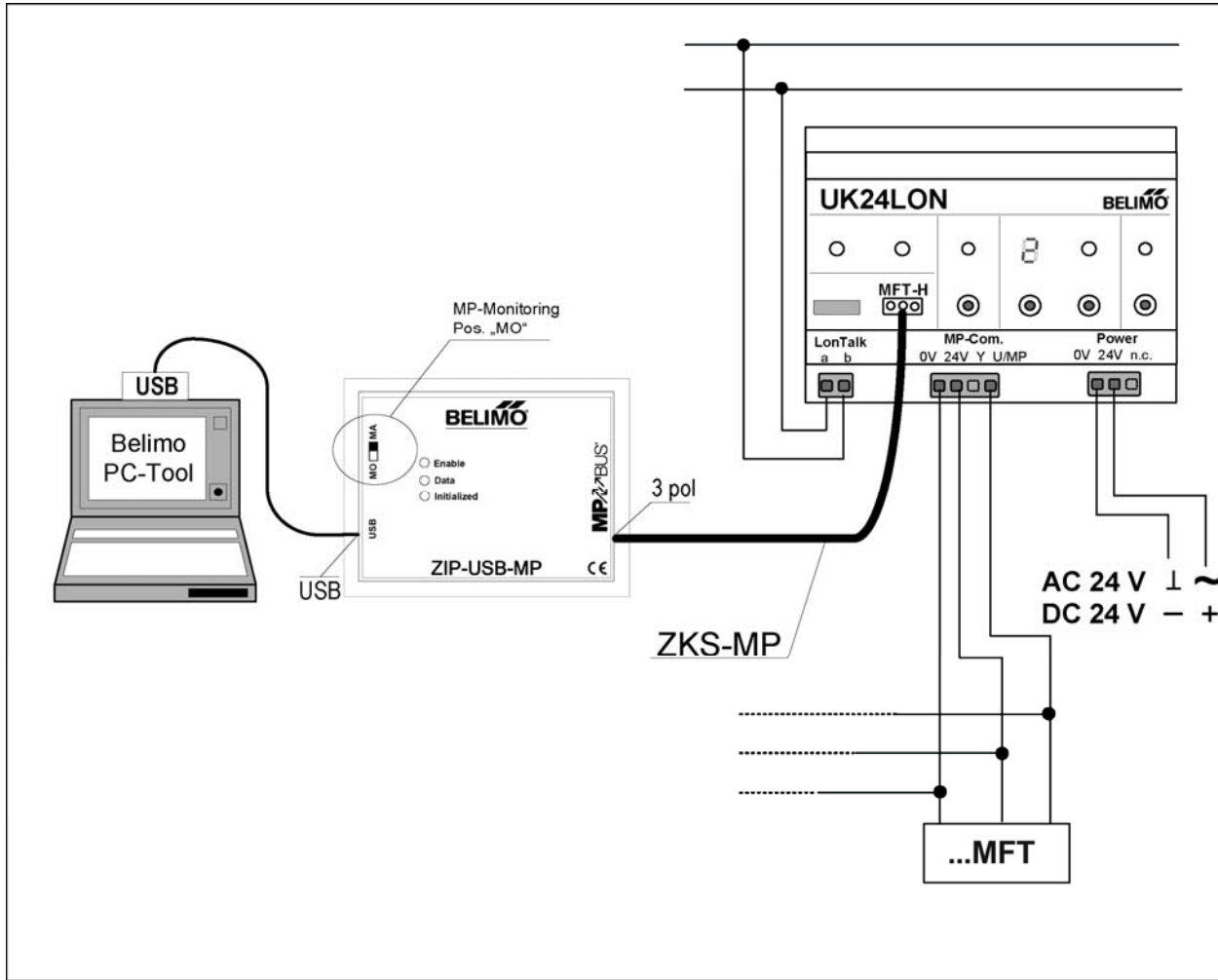

IM40035 - 05/10 - Subject to change. © Belimo Aircontrols (USA), Inc.

## 2.1.1 Driver Installation

A driver must be installed on the PC in order to use the ZIP-USB-MP. This driver can be downloaded from the Belimo website (Download section). Once the driver has been installed, the ZIP-USBMP is logged in on the PC as a virtual COM port.



---

### Supported operating systems

---

Windows Vista  
WindowsXP  
Windows 2000  
Windows ME  
Windows 98  
Windows 98 SE

---

### Preparation

---

Download the zipped “Driver\_ZIP-USP-MP.zip” file from the Belimo website (Download section) to a folder on the hard disk of your computer. Then extract the ZIP file. The ZIP file contains the following files:

- 98\_ME\_zipUSBMP\_Driver
- XP- 2000- ZIPUsbMP- Driver
- ZIPUSBMP\_drivinst\_d.pdf
- ZIPUSBMP\_drivinst\_e.pdf
- ZIPUSBMP\_dok\_d.pdf
- ZIPUSBMP\_doc\_e.pdf

**Installing**

- A) Connect the ZIP-USB-MP to the USB port on your computer. The computer reports that it has detected new hardware and opens the following screen automatically: **Hardware Update Wizard**.
- B) Click the radio button as shown in the next screenshot: **Install from a list or specific location (Advanced)**.



- C) Then click **“Next”**.
- D) Check the box as shown in the next screenshot: Include this location in the search, then select the folder to which you extracted the driver (see step 1; in this example ZIP-USB-MP).



IM40035 - 05/10 - Subject to change. © Belimo Aircontrols (USA), Inc.

E) Select the XP\_2000\_ZipUsbMP\_Driver folder and then click **“OK”**.



F) Click **“Next”**.



G) The driver is now installed.



H) Click **“Finish”**.

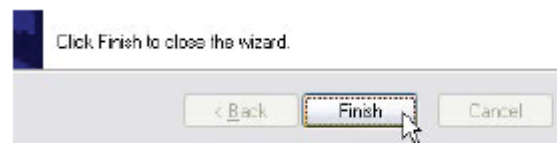

- I) After the driver has been installed, the USB port must be paired to a COM port. Click the radio button in the Wizard as shown in the next screenshot: **Install from a list or specific location (Advanced)**.

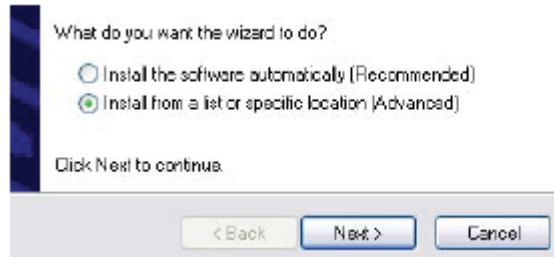

- J) Click “Next”.

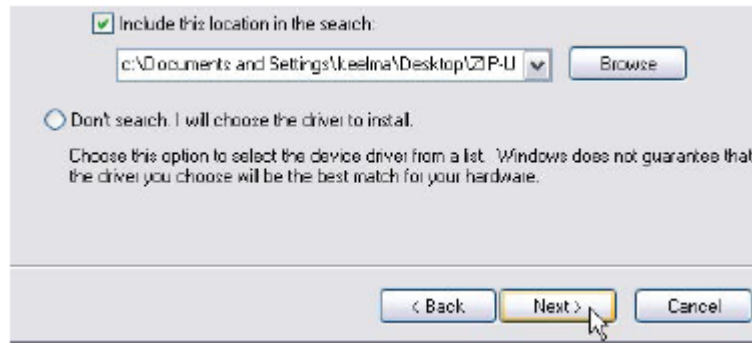

- K) The USB port is now paired to a COM port.

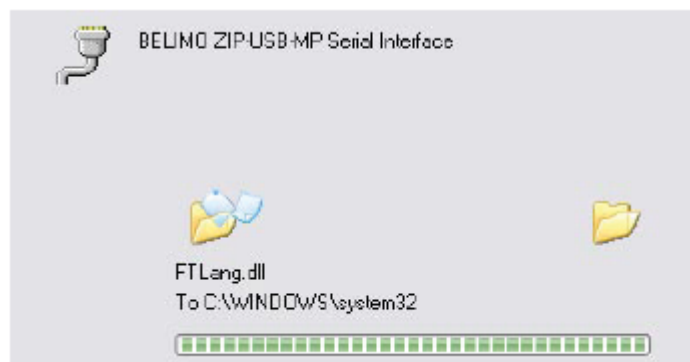

- L) Click “Finish”.

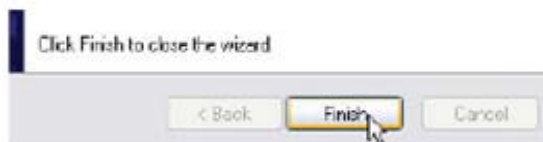

**NOTE: If a warning appears during the installation procedure, please ignore it and click “continue installation”. The driver is the loaded correctly. Your system is not damaged in any way.**

IM40035 - 05/10 - Subject to change. © Belimo Aircontrols (USA), Inc.



2.1.2 Checking

**Check the USB/COM connection on your computer.**

You must define a COM port number under “**Options**” in order to work with Belimo PC-Tool MFT-P v3. To find out which COM port number is the correct one, you need to check which COM port the USB port was automatically connected to by the system.

- A) Select “**Settings/Control Panel/System**” in the Windows “**Start**” menu. On the “**Hardware**” tab, click “**Device Manager**”.



- B) You can see here that the USB port on the ZIP-USB-MP has been connected to COM 8, for example (a different COM number may apply on your PC).



### Selecting the same COM port in PC-Tool Version 3.4

After selecting the COM port, for example “COM=8” (a different COM number may apply on your PC), you can set to work with the Tool.

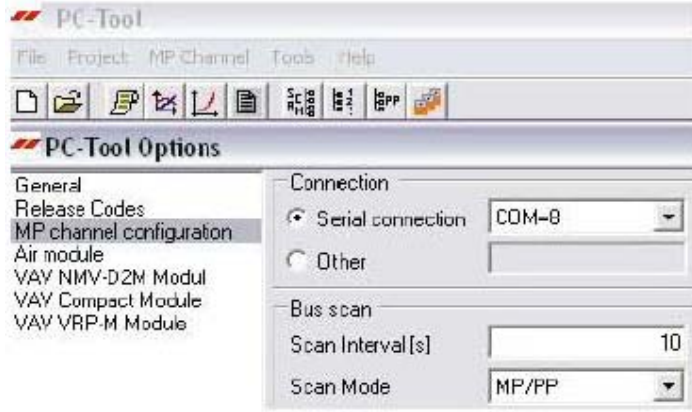

## 2.2 Starting the program



Click the program icon on your desktop. A start screen appears. Click the Start button (bottom right).

## 2.3 Adapting PC-Tool options

When you start the program for the first time, a dialog is displayed for adapting the user-specific settings.

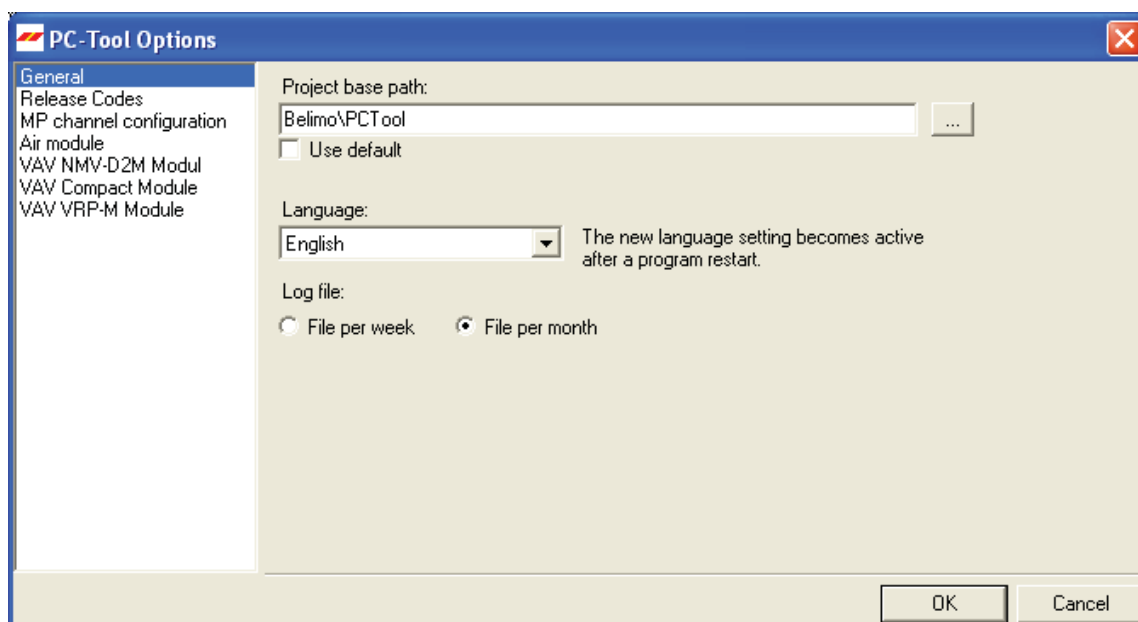

*PC-Tool options*

Select the desired language in the combobox here. If you change the language, exit the program and restart it.

## 2.4 Creating a new project

To work with the program, you have to create a "project". The dialog for entering the project data is displayed. Click the radio button "New project".



*Creating a new project*

The project name, company and user ID must be filled in; all other information is optional.

## 2.5 Setting up the program

The project and the MP-Channel can be seen in the outline bar [C]. The bus is scanned every 10 seconds by default.

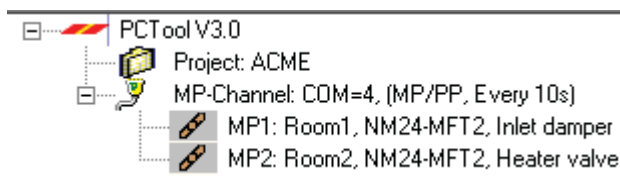

*Outline bar [C]*

If no actuators are shown after 10 seconds, you should check whether the level converter ZIP-USB-MP is connected to the right COM interface. Adjust the settings for the serial interface if necessary [⇒ 3.3.1].

## 2.6 Displaying actuator parameters

Select the desired actuator in the outline bar [C] by clicking it with the mouse.

The current settings for the actuator are displayed in the detail area [D].

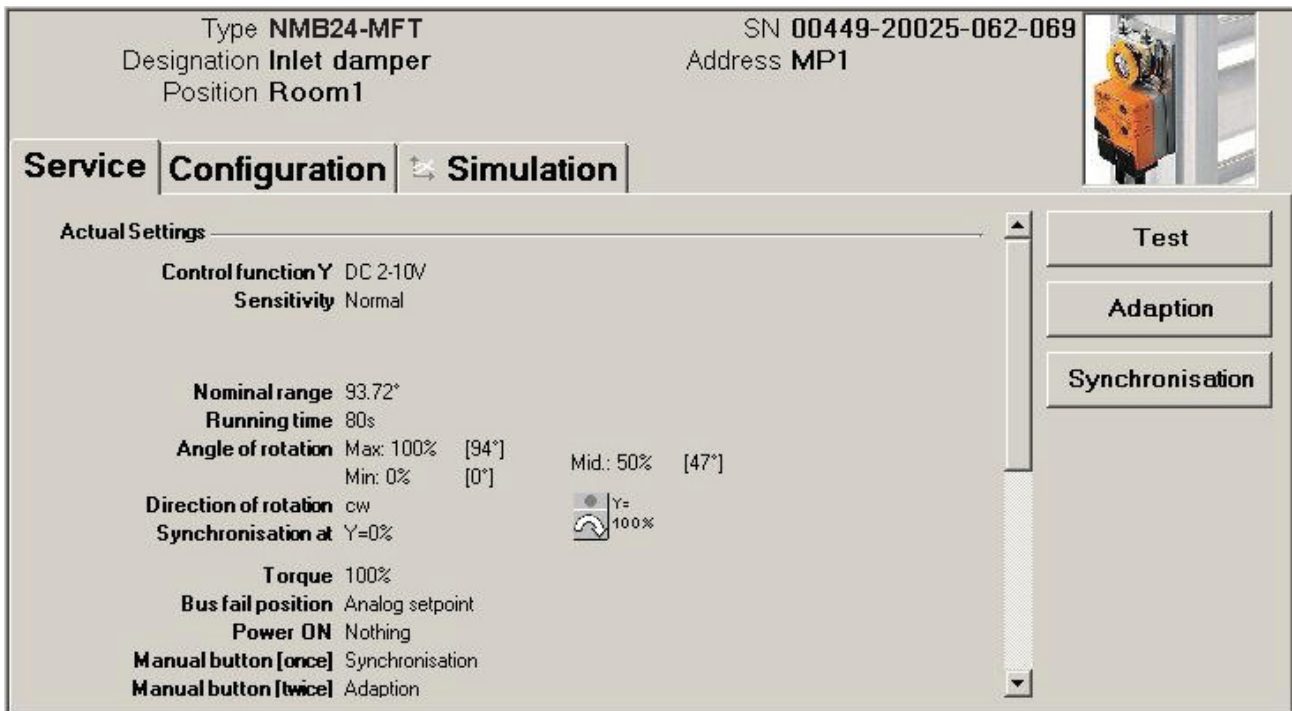

Example of detail area [D] (damper actuator)

## 2.7 Further actions

Read the descriptions for the following topics in Section 3 Basic functions

- Bus scan
- Setting the bus address
- Parameterization of actuators

Read the details for the application areas of the actuators in the descriptions of the following modules

- Damper actuators (Air module)

## 3 Basic functions

---

### 3.1 Program start

After the program is started, a start screen is displayed. Click Start.

Determine the project with which you would like to work. You can either

- open one of the last projects listed,
- open an existing project from a file, or
- create a new project.

The defined MP-Channel is displayed and opened. A bus scan is started for each MP-Channel.

---

If only one actuator is connected, it is automatically selected and displayed.

---

**Option** If you cancel the project selection, the program will be started without a project. In this case, only the functions Help, File ▶ New project and File ▶ Open existing project will be available.

You can also start the program by means of opening a project file: In the Explorer, double-click a file with the extension `.bptpj` or on a corresponding file link.

---



If you create a link to a project file on the desktop, make sure that you do not inadvertently move or copy the file instead. You can tell when a link has been created correctly by the small arrow in the bottom left-hand corner of the file icon. (If the project file itself, rather than a link to it, is on the desktop then all other files will be saved there as well.)

---

In a network environment, the program should be installed on your workstation and started locally. Special authorizations are required to start the program on network drives.

---

## 3.2 Projects

### 3.2.1 Project data

All user-specific data of the program are administered in the framework of projects. Each project has a project directory in the file system. The project files are stored in sub-directories of the project directory.

---

The storage place of the project files is described in the Appendix.

---

### 3.2.2 Creating a new project

Select File ►, New Project in the main menu. Enter the new project data in the dialog. The project name, company and user ID must be filled in; all other information is optional. Click OK.

Since only one project can be active at a time, the currently displayed project will be closed and the new project opened.

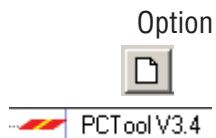

Option

You can also create a new project by clicking the New Project icon on the toolbar [B] or clicking the program icon in the outline bar [C] with the right mouse button and then selecting New Project.

### 3.2.3 Opening a project

Select File ► Open Existing Project in the main menu. A list of all project files in the storage location is displayed.

Mark a project from the list in the dialog or open any given project file (\* .bptpj) with Find.... Click OK.

Since only one project can be active at a time, the currently displayed project will be closed and the selected project opened instead.

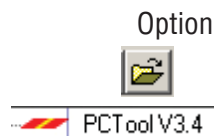

Option

You can also create a project by clicking on the New Project icon on the toolbar [B] or clicking the program icon in the outline bar [C] with the right mouse button and then selecting Open Project.

### 3.2.4 Changing project data

Click the project in the outline bar [C] to display the project data. The Edit button (far right) displays a dialog in which you can change the data.

Option

Click the project in the outline bar [C] with the right mouse button and select Properties. Project name and path cannot be changed within the program. However, you can rename the project file (extension .bptpj) using the Windows Explorer or move the entire project folder to another location. Afterwards, open the project again.

---

The project folder and project file can have different names – for example for backing up data. The name of the project file determines the project name.

---

### 3.2.5 Exporting a project

Copy the entire project folder in the Explorer, for example onto a CD or thumbdrive.

### 3.2.6 Copying a project

Copy the entire project folder to another location in the Explorer. Give the project folder a new name. Give the project file (<project>.bptpj) the same name within the new project folder.

### 3.2.7 Deleting a project

Delete the entire project folder in the Explorer. The project to be deleted must not be currently open in the program.

## 3.3 MP-Channel

### 3.3.1 Serial interface



MP-Strang:

The ZIP converter is connected to a serial interface (COM) for connecting the MP/MFT actuator or the MP-Bus to the PC-Tool. To select the number of the serial interface used on your computer, click the MP-Channel icon in the outline bar [C] and select MP-Channel settings.

For typical wiring diagrams, see ⇨ 4.4 Typical wiring diagrams

Now set the serial connection:

- If you activate the "Serial connection" box (as shown in the screenshot), you can select a serial connection. This list shows all ports on your computer (between COM=1 ... COM=255).
- Option: If you activate the "Other" box, you can enter a connection ID in the text box. Valid values are:

"COMx" or "COM:x" or "COM=x" (x is the port number between 1 and 255).

"Baudrate=x" (x is the baud rate 75...115200).

"Bytesize=x" (x is the number of data bits 5...8).

"Stopbits=x" (x is the number of stopbits 1, 1.5 or 2).

"Parity=x" (x is the the parity no, odd, even, mark or space).

It is only mandatory for the COM port to be specified. Separate the values with a semicolon (;).

Example:

"COM1;Baudrate=9600;Stopbits=1".



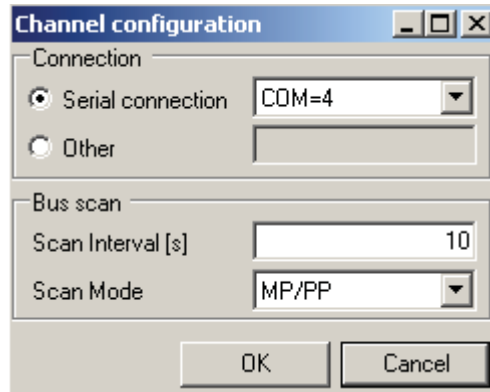

*MP-Channel settings*

### 3.3.2 Bus scan

In the bus scan section of the "MP-Channel settings" dialog, you can enter the time interval for the periodic bus scan in seconds. Permitted values are whole numbers between 1 and 9999.

The program can address actuators in two basic ways:

In multi-point mode (MP), up to 8 actuators of the types MP / MFT can be individually digitally addressed.

In point-to-point mode (PP) only a single actuator can be activated. In this case, the "classic" operating modes are available with response voltage at connection D5.

Select the type of bus scan in the bus scan section of the "MP-Channel settings" dialog:

PP Only	Connection of a single actuator in PP mode
MP / PP	First scan address 1 to 8 in MP mode. If there is no response in MP mode, switch to PP mode.

#### Periodic bus scan

The periodic bus scan is active by default. To switch this off, click the MP-Channel with the right mouse button and select Interrupt scanning. Afterwards, you can switch the periodic scan back on again the same way with the menu item Scan Every xx Seconds.

#### Manual bus scan

Manually activate an immediate bus scan with the function button F5 ("Update") as needed. This is possible at any time, even when the periodic bus scan is active.

Option You can also select MP-Channel ▶ Trigger Scan in the main menu or activate the Trigger scan function by clicking the MP-Channel with the right mouse button.

If more than one actuator responds at the same MP address during a bus scan or if more than one actuator is connected in PP mode, a bus jam will occur. This situation is indicated by the program with a corresponding message.

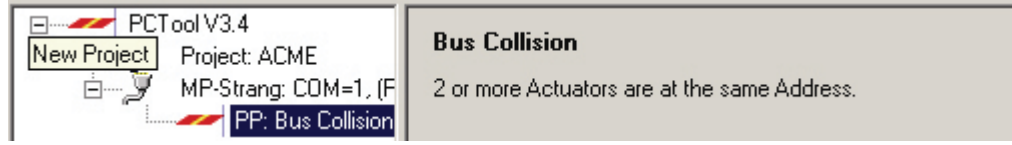

Saving a bus scan overview in a file

The result of a bus scan can be saved in a file for recording. Select "Channel" in the outline bar to show an enumeration of all found MP nodes with the corresponding data (address, position, type, description and serial number).

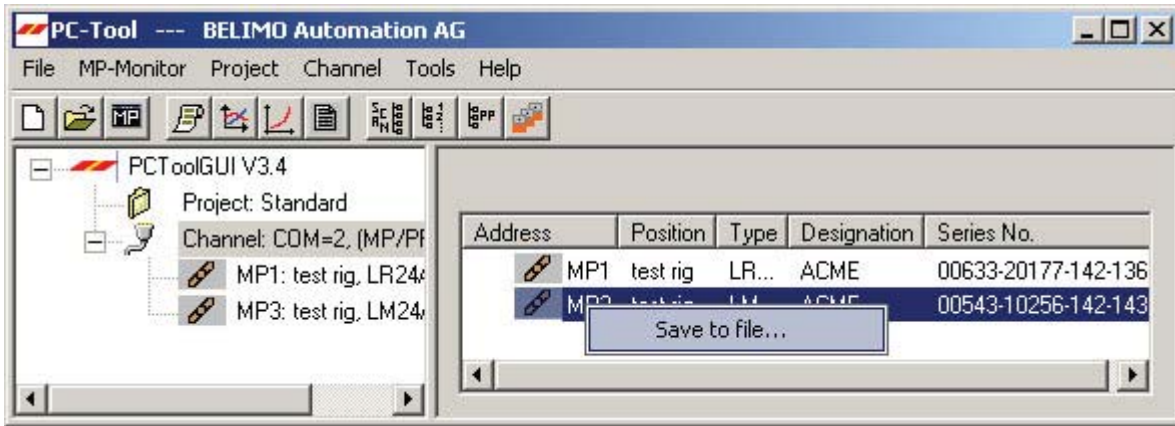

*Saving the bus scan overview*

Click the right mouse button to open the context menu and choose "Save to file" for saving the information in a text file.

### 3.4 Setting the bus address

Each actuator with an MP-Bus interface (valid for all devices with an MP-Bus interface, e.g. I/O modules, etc.) can be assigned an address which it will use to communicate on the MP-Bus.

The setting of the bus address can be disabled on certain actuators, e.g. for the actuator types ...LON and ...ALON (for LONWORKS®).

**NOTE: USE THIS SECTION ONLY IF THE ACTUATORS (S) MP ENABLED.**

3.4.1 Series addressing of actuators



Click the Address device icon in the toolbar [B].

Option Click the MP-Channel with the right mouse button and select Addressing Device. Or select MP-Channel ► Addressing Device in the main menu.

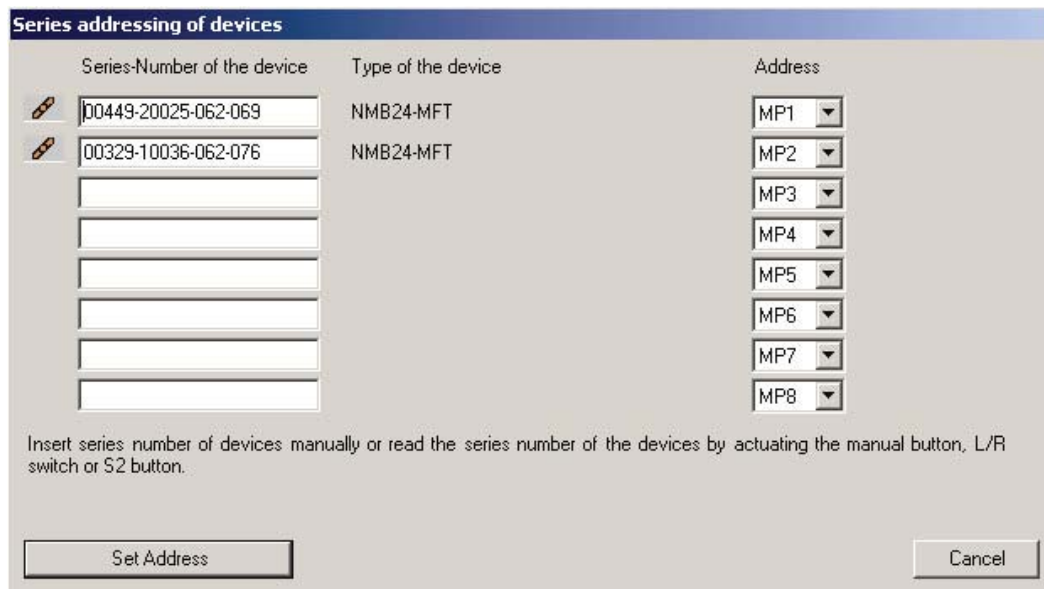

*Series addressing*

If one of the addresses is already assigned to another actuator, a message will be displayed:



*Message when an address is already assigned (series addressing)*

Click Yes to initially release the address. The actuator that used to occupy the address is set to PP.

If you select No, the actuator will be set to the already assigned address and a bus jam can occur.

Click Cancel to stop the series addressing at this point. You can now rearrange the addresses or end the entire process.

### 3.4.2 Addressing with known serial numbers

Each MP/MFT actuator is delivered with a label containing its individual serial number. These serial numbers can be used to assign a PP or an MP1 ... MP8 address to the actuator. An additional, removable label with an identical serial number is supplied with the actuator. If the actuator is installed at a particular position in the system, this additional label can be affixed at the same position in the system diagram. This records where the actuator with the corresponding serial number is located in the building. These serial numbers can be used to assign the MP1 ... MP8 addresses to the actuators.

You can also fill in the input boxes manually before clicking Set Address, for example when the buttons of the actuators are not accessible or you regularly take the serial numbers from your documents.

### 3.4.3 Resetting actuator addresses

If you want to reset actuators with MP addressing to PP, click to the right of the MP-Channel and select "De-address Device" in the pop-up menu.

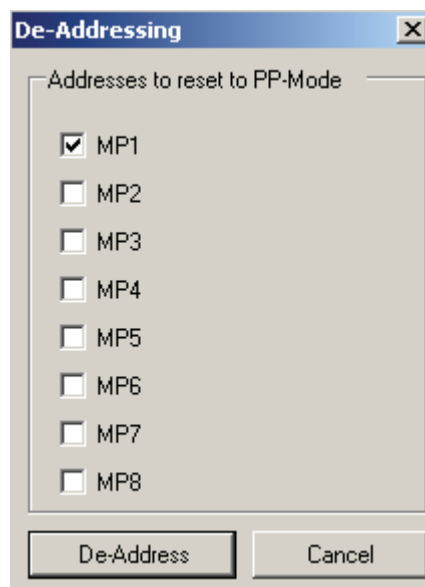

*Selection of the addresses to be reset*

Mark the addresses whose actuators are to be de-addressed.

---

When the bus scan is set to MP/PP, the de-addressed actuators are no longer visible in the outline bar [C] as long as there are still actuators with addresses.

---

If you set several actuators to PP, a bus jam will occur with the bus setting "PP only".

---

### 3.4.4 Addressing a single actuator



Select the actuator in the outline bar [C] and click the "Change MP Address" icon in the toolbar [B].

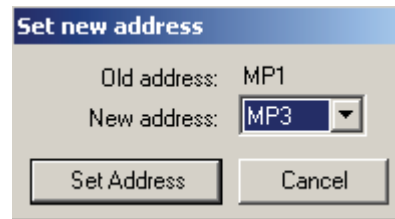

*Setting a new address*

Option Click the actuator with the right mouse button and select "Change MP Address" ("MP-Adresse ändern").

Select the new address in the combobox. If the address is already assigned to another actuator, a message will be displayed:

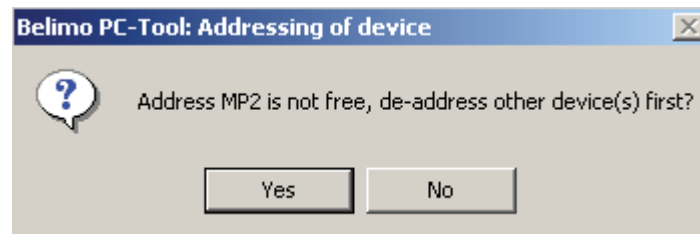

*Message when an address is already assigned*

Click Yes to initially release the address. The actuator that used to occupy the address is set to PP. If you select No, the actuator will be set to the already assigned address and a bus jam can occur.

### 3.5 Selecting a module

All actuators that are active and connected to an MP-Channel are displayed in the outline bar [C]. Select the desired actuator from this display.

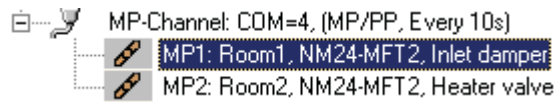

The type of actuator is indicated by the icon:

Icon	Actuator type
	Damper actuator
	Valve actuator
	Window ventilation actuator
	Actuator for fire dampers
	VAV (Variable Air Volume) controller actuator
	THC24-MP
	UST-3 I/O module
	Unknown actuator

When an actuator is selected for the first time, the parameters are read out and displayed in the detail area [D].

In addition, the address for communication on the MP-Channel (MP or PP mode) and the name of the actuator type are displayed in the outline bar [C].

The complete information for identifying the selected actuator is found in the header of the detail area [D].

Type <b>NMB24-MFT</b>	SN <b>00449-20025-062-069</b>
Designation <b>Inlet damper</b>	Address <b>MP1</b>
Position <b>Room1</b>	

*Display of the actuator identification*

---

Note the difference between the current communication mode on the MP-Channel and the displayed address. An actuator with the address MP2 can be activated in PP mode during a bus scan, for example.

---

### 3.6 Actuator parameters

#### 3.6.1 Displaying actuator parameters

The parameters of an actuator are displayed on the Service tab in the detail area [D].

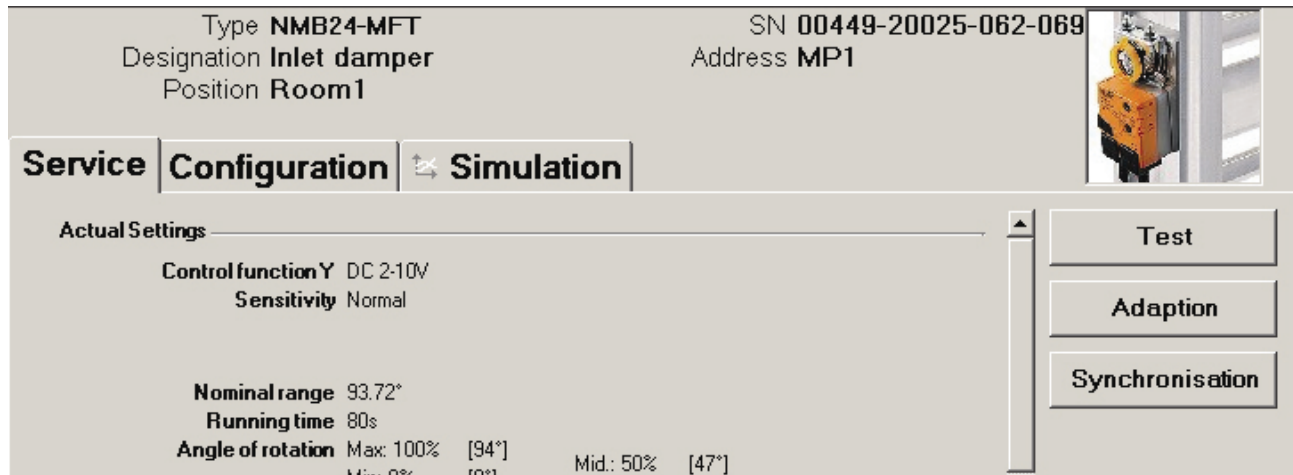

*Example of the "Service" tab (damper actuator)*

The Test, Adaptation and Synchronization functions are described for each respective module.

#### 3.6.2 Printing out actuator parameters

The displayed actuator parameters can be printed out. Click the printer icon in the toolbar [B] or select Print Actuator Parameters in the pop-up menu after clicking the actuator in the outline bar [C] with the right mouse button.

#### 3.6.3 Deleting maintenance/error messages

When an actuator has created and saved maintenance or fault messages, these are displayed on the Service tab.

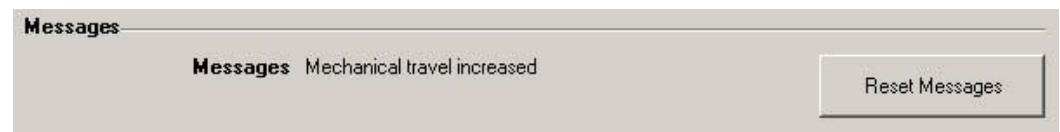

*Message display on the Service tab*

Use "Reset messages", to delete the messages stored in the actuator.

Following messages may appear:

<b>Message</b>	<b>Description</b>
Mechanical travel increased	Expected end stop value for top or bottom has been overrun.
Mechanical overload	Actuator did not reach set point because an obstacle has reduced the operating range
Excessive utilisation	Actuator moves to often compared with the total operating time (typical relation of active time to operating time is greater than 25%)

Actuators for fire & smoke dampers have provide a larger scale of messages. The specific messages are described in the Fire & Smoke module.



### 3.7 Configuring an actuator

To change the parameters of an actuator, go to the Configuration tab.

Type **NMB24-MFT** SN **00449-20025-062-069**  
 Designation **Inlet damper** Address **MP1**  
 Position **Room1**

**Service** **Configuration** **Simulation**

Designation   
 Position   
 Control signal Y  Start Stop

Angle of rotation	Min	Mid	Max
	<input type="text" value="0"/> % (0..67%)	<input type="text" value="50"/> % (0..100%)	<input type="text" value="100"/> % (33..100%)
	<input type="text" value="0"/> °	<input type="text" value="47"/> °	<input type="text" value="94"/> °

Running time  s (74..296s)

Read  
Write  
Store to file...  
Load from file...

Example of the "Configuration" tab (damper actuator)

The lower area with the basic settings can be displayed with the "More..." button and hidden again with the "Less" button.

When you change a value in an input box, the box turns yellow:

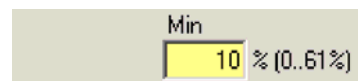

The status image on the right additionally shows whether all the displayed values match those stored in the actuator:



Display matches actuator

*Status image*



Values have been changed

Save the changed values in the actuator with the "Set" button underneath the status image. You can read out the parameters currently saved in the actuator again with the "Read" button. Entries for values that you have not previously saved in the actuator will be lost as a result.

### 3.7.1 Saving a parameter file

You can store the displayed parameters in a file (with the extension .btpar) with "Store to file..." on the "Configuration" tab. The suggested name for the file consists of the project, the actuator type, the position, the serial number, the current date and the time of day.

---

Since the content of the file corresponds to the values displayed on the screen, you can change individual values and save Options in files without loading them on the actuator.

The file can only be saved when all values on the screen are valid.

---

### 3.7.2 Loading a parameter file

The values of a saved parameter file can be read back into the input screen for the configuration with "Load from file...".

### 3.7.3 Copying parameters

Read out the parameters of an actuator that you want to copy and save them in a file. Change the actuator, load the saved parameters from the file and program the actuator with the copied values.

### 3.7.4 Load factory settings

When a project is created, two folders are created in the parameter directory. These folders contain the factory settings for all supported actuator types.

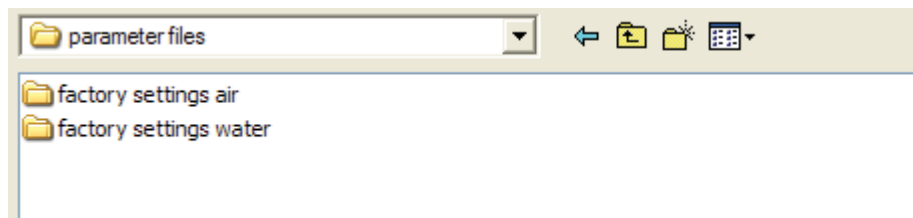

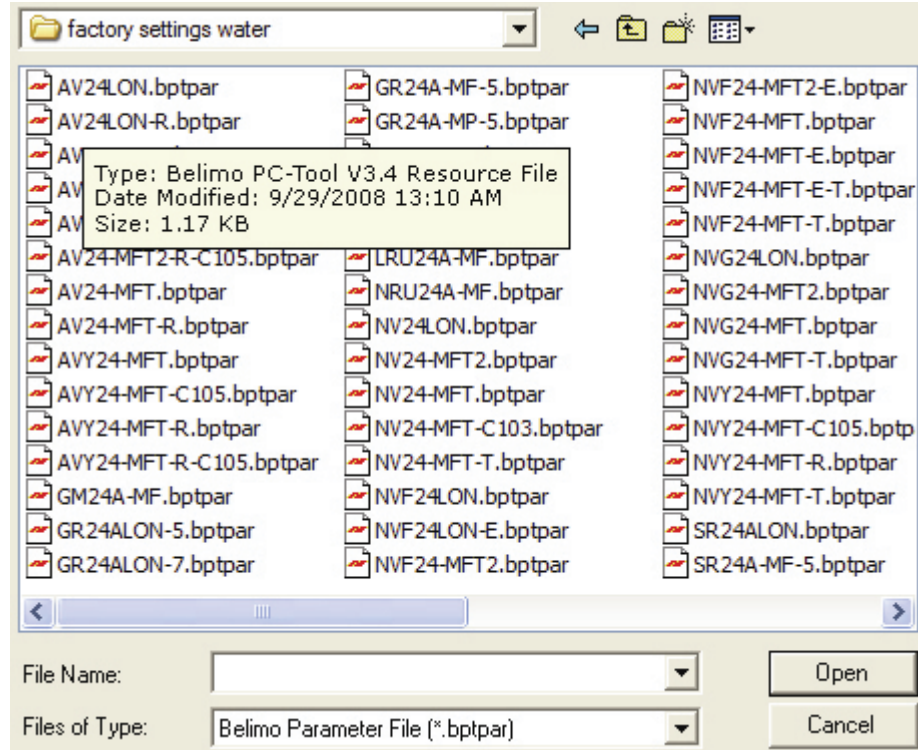

*Parameter files with factory settings*

Open the file which matches the actuator type. The settings are loaded into the input screen for the configuration. Afterwards, store the parameters in the actuator with the "Set" button.

**NOTE: USE THIS SECTION ONLY IF THE ACTUATORS (S) MP ENABLED.**

### 3.8 Parameterizing limited lots

You can parameterize several identical actuators with the function "Parameterize Limited Lots". The number depends on the power of the voltage supply.

To parameterize limited lots, save the parameter set to be programmed in a file.

With one parameter set, you can only program actuators from the same actuator family (e.g. MFT), i.e. the parameter set used must match the actuator family.

Connect the devices according to the following wiring diagram (for further wiring diagrams, see clause 4.4 Typical wiring diagrams):

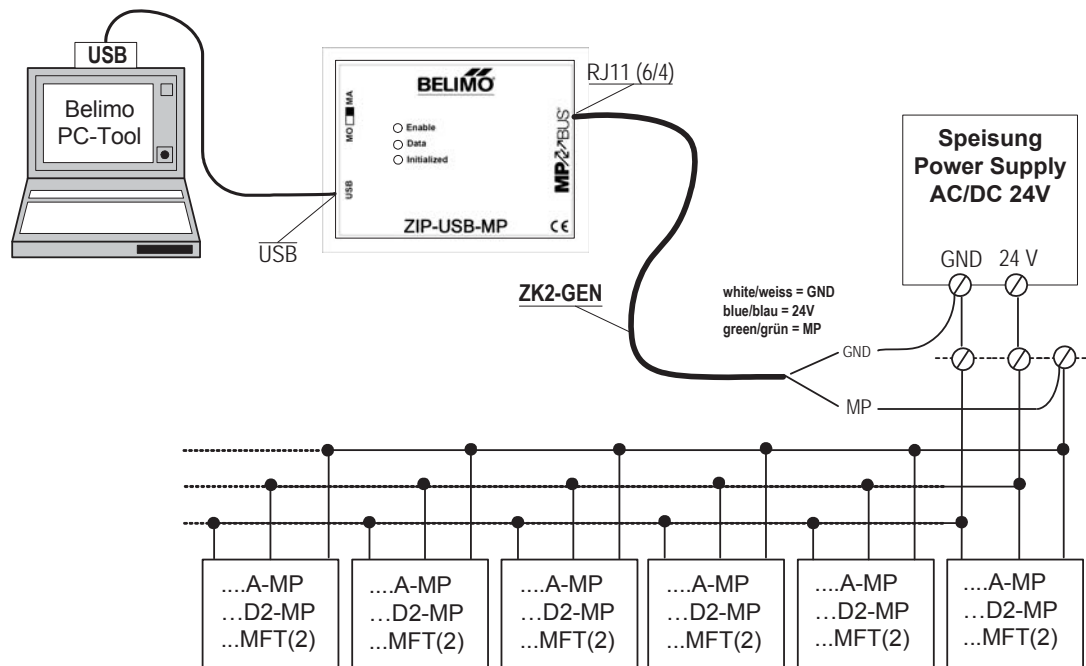

Select the desired MP-Channel and click the symbol "Parameterize Limited Lots".

- Option Click with the right mouse button on the MP-Channel and select Parameterize Limited Lots. Or select the MP-Channel ▶ Parameterize Limited Lots in the main menu.

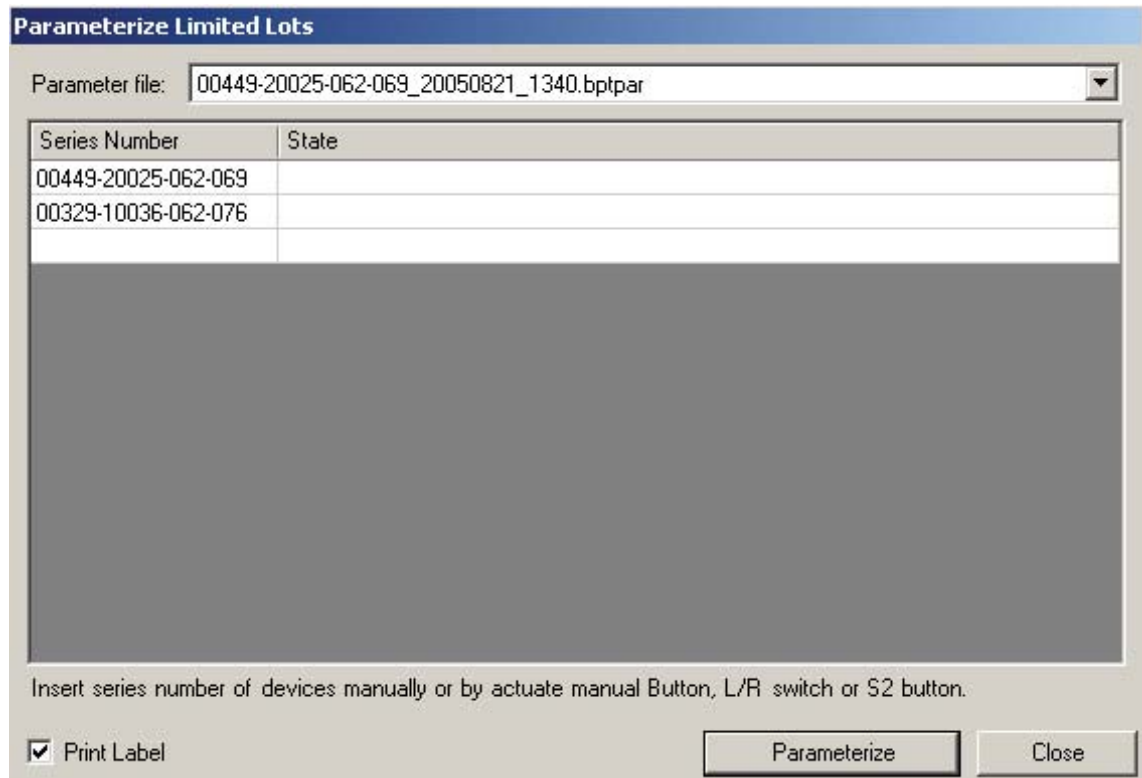

*Dialog for parameterizing limited lots*

Select the file with the saved parameters in the dialog.

Position the cursor in the first input box for the serial number. Then press the acknowledge button on the first actuator which should be parameterized. If the buttons are not accessible, directly enter the serial numbers as described below.

The serial number of the actuator is read out after the acknowledgement and written into the input box. The cursor jumps to the next line.

Repeat the process for all actuators that are to be parameterized and mark the checkbox if you want to print labels after parameterization (see Section 3.9 "Printing labels").

Click Parameterize.

The PC-Tool now asks for the file with the values to be written into the actuators.

The periodic bus scan is stopped for the duration of the parameterization. The actuators are successively set to the address MP1, programmed and finally set to PP addressing.

When the bus scan is set to MP/PP, the actuators in the outline bar [C] will not be visible. If the bus setting PP only is used, a bus jam will result.

If an error occurs during programming, a corresponding text is displayed in the "State" column.

If the address MP1 is already assigned to an actuator, a message will be displayed:

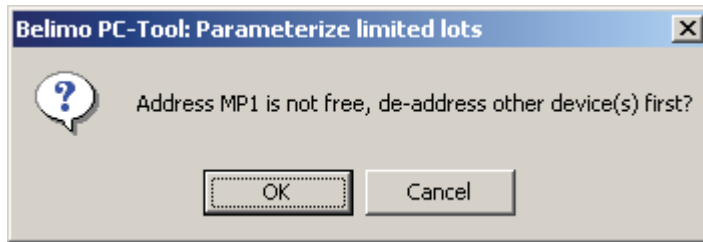

*Message when the address MP1 is already assigned (limited lot)*

Click OK to initially release the address MP1. The actuator that used to be assigned to this address will be set to PP.

Click Cancel to stop the parameterization at this point.

#### Identification with known serial numbers

You can also fill in the input boxes manually before you click "Parameterize", for example when the buttons of the actuator are not accessible or you regularly take the serial numbers from your documents.

#### Programming further series

The actuators that have been successfully programmed are deleted from the list. You can register further serial numbers in the list and then click "Start parameterization" again.

### 3.9 Printing labels

To identify actuators, you can write self-adhesive labels with the PC-Tool program. A special printer may be necessary, depending on the type of label.

#### 3.9.1 Setting up a configuration file

Labels are defined per project. To print labels, set place holders (number in brackets) in the configuration file for the information to be printed.

---

The structure and storage location of the configuration files are described in the Appendix.

---

#### 3.9.2 Printing labels



Select an actuator and click the "Print Label" icon (with an orange background).

Option Click an actuator in the outline bar [C] with the right mouse button and select "Label Printing".

*Label printing dialog*

Select a printer and a configuration file.

Enter the number of identical labels that are to be printed for "Number of labels per actuator". When parameterizing limited lots, the total number of printed labels is equal to this value times the number of actuators.

Enter the desired texts {41} – {44} that are to be printed, if necessary. A maximum of 50 characters are available per text box. In text with consecutive numbering, a number is entered instead of the place holder "#". This number is increased by one for each new actuator.

If labels have already been used from a label sheet, you can specify at what label position the printing should start (for example 4 when 3 labels have been used from the first row).

Your entries and the selected printer are preserved from one label printing process to the next (automatic saving). You can empty the input boxes with Reset Form.

---

The texts {41} – {44} must be present in the label configuration file in the form of place holders. Otherwise, they will not be printed out.

---

### 3.9.3 Printing labels offline

Labels can still be printed even if no actuator is connected. In this case, only the information from the project data, the texts entered in the dialog and the current date can be output. The start number is always used instead of the place holder #.



Click the "Print label" icon (with gray background).

Option Click the project in the outline bar [C] with the right mouse button and select "Label Printing". Or select Project ► Print Label in the main menu.

For Number of labels per actuator, enter the number of identical labels to be printed. The number with the placeholder "#" is NOT counted up. The further procedure is the same for printing actuator labels.

---

**NOTE: USE THIS SECTION ONLY IF THE ACTUATORS (S) MP ENABLED.**

---

## 3.10 Transformation tables

Transformation tables are for converting the sensor value into another physical quantity, for example from resistance (in ohms) to temperature (in °C) for NTC resistors. Several frequently used transformation tables are supplied with the program.

Selecting a transformation table

Select a transformation table with the combobox. The corresponding converted value is displayed underneath the sensor value.

---

The measured sensor variable in the table must match the selected sensor type: volts for active sensors, ohms for sensor resistors, on/off for switches.

---



Adapting a transformation table



Click the transformation table icon.

Option

Click the project in the outline bar [C] with the right mouse button and select Transformation table. Or select Project ▶ Transformation table in the main menu.

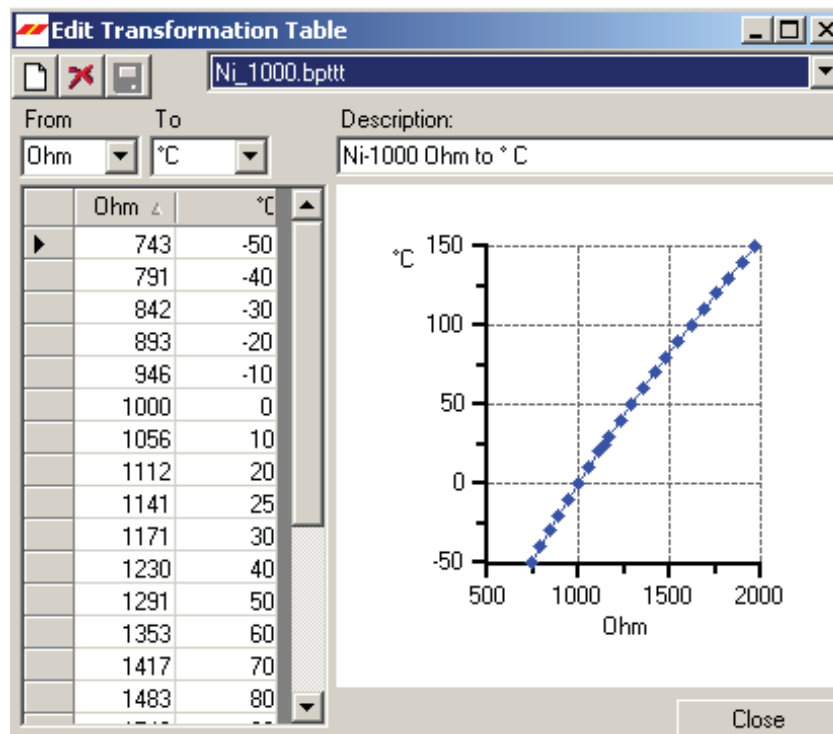

Dialog for editing transformation tables

Select an available transformation table using the combobox.

The sensor values and the converted values are displayed in the table on the left. On the right, you see a corresponding diagram with the sensor values on the horizontal axis and the converted values on the vertical axis. The table values are *linearly interpolated*; in other words, the points are connected by straight lines to calculate intermediate values.

During conversion, the first and last connection lines are extended beyond the range of entered points (*extrapolated*) so that even sensor values outside of this range are valid.

You can adapt each value in the table or add new value pairs in the last line, which is marked with an asterisk (\*). Newly added value pairs are automatically sorted into the right place.

---

The following holds true for switches: Off = 0, On = 1.

---



Save the changes to the transformation table by clicking on the floppy disk icon.

---

When you change a transformation table in one project, the changes do not affect corresponding tables in other projects. However, you can return to the original project folder from all projects through the entry <Other...> in the combobox and open the changed table.

---

#### Setting up a new transformation table



When the dialog for editing a transformation table is open, you can create a new table with the "New" icon. Select the physical quantities for the sensor values and the converted values in the comboboxes above the table. You can also write any other quantities into the text boxes of the comboboxes.

---

For the sensor values, only volts, ohms and on/off are meaningful input quantities, because only these sensor types are supported.

---

Enter a description in the text box and add new value pairs in the last line of each table, which is marked with an asterisk (\*). A transformation table must have at least two lines.

---

For switches, you can define an on/off inversion table with the assignments  $0 \rightarrow 1$  and  $1 \rightarrow 0$ .

---



Save the new transformation table by clicking on the floppy disk icon. The name that you enter in the "Save file as" dialog will be subsequently offered as a selection in the combobox.

---

If the name of the new table does not appear in the combobox on the "Simulation" tab, open the project again.

The new transformation table is not directly available as a selection in the combobox in other projects. However, you can return to the original project folder from all projects through the entry <Other...> in the combobox and open the new table.

---

#### Deleting a transformation table



When the dialog for editing a transformation table is open, you can use the Delete icon to delete a table that has been selected in the combobox.

---

If the name of the deleted table still appears on the "Simulation" tab in the combobox, open the project again.

---

### 3.11 Displaying recorded trend data



Click the symbol Trend display.

Option Click the project in the outline bar [C] with the right mouse button and select "Trend Recall". Or select Project ► Trend Recall in the main menu.

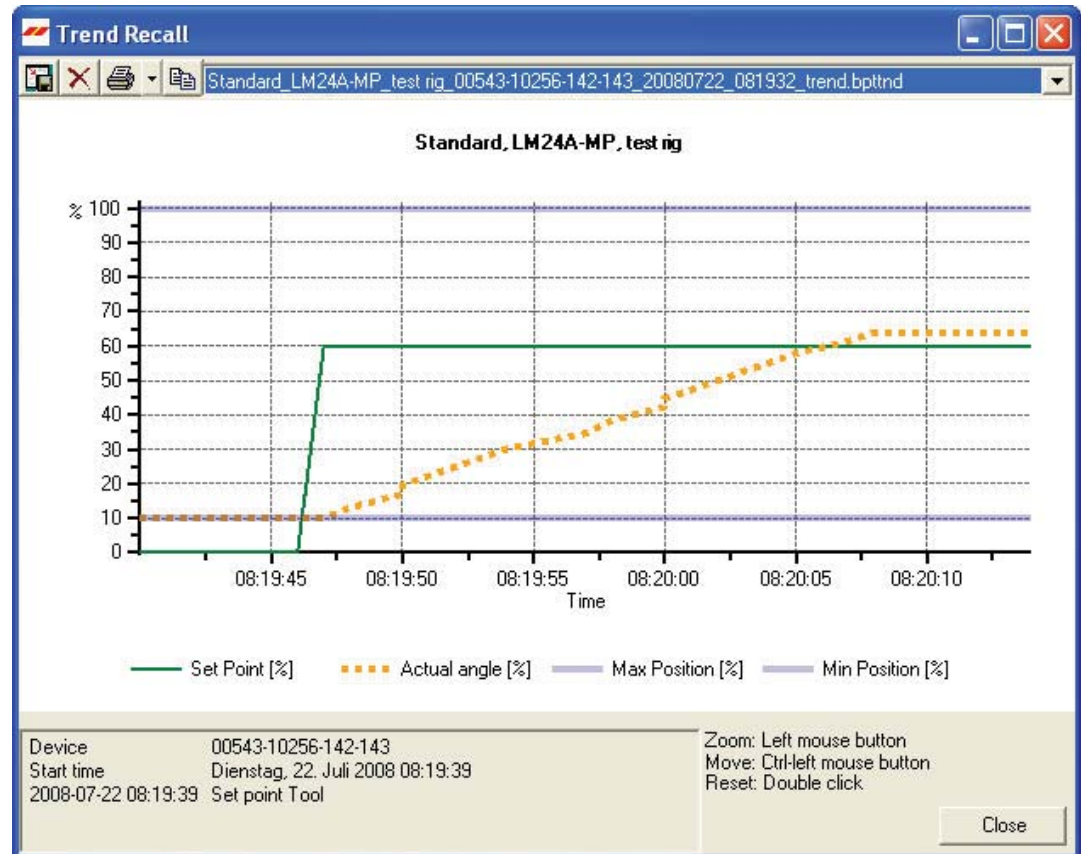

#### Trend recall

Select a trend file with the combobox.

Keep the CTRL key pressed and pull the diagram to the left or right with the mouse in order to display values for other times.

You can use the copy button to insert the diagram into other documents via the clipboard.

Use the save button to fix the window size of the trend display.

#### Printing a trend

Click the Print icon or press the key combination CTRL-P.

Option In addition to the Print button, you can open a menu with the "down" key. In addition to printing, this allows you to display a preview or select several files for printing with "Print multiple".

### 3.12 PC-Tool options

Select Tools►PC-Tool options... in the main menu.

Option Click the project in the outline bar [C] with the right mouse button and select PC-Tool options...

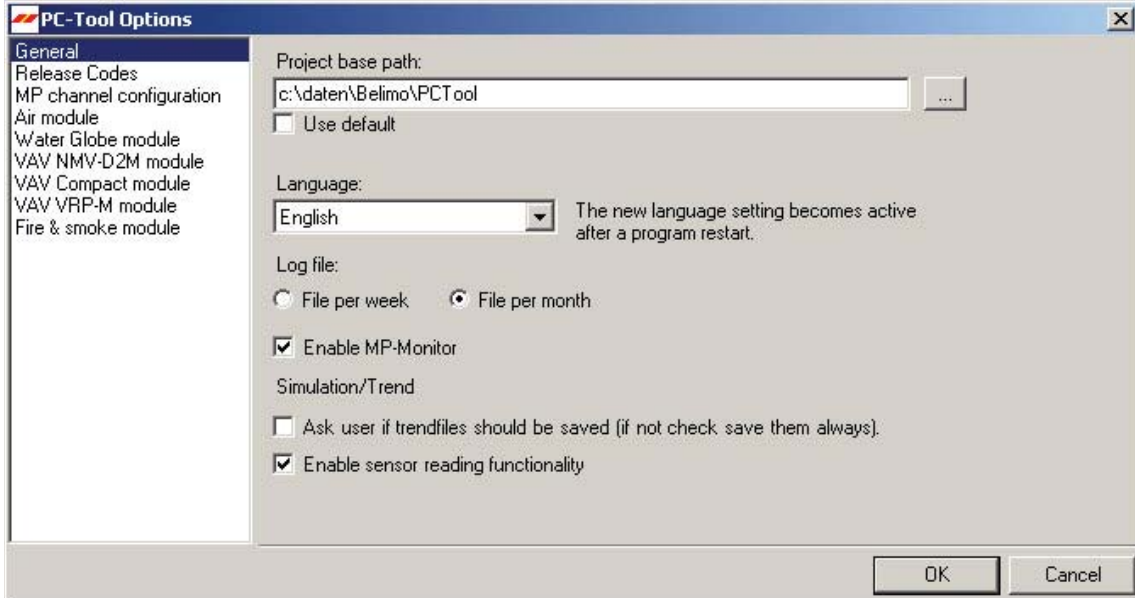
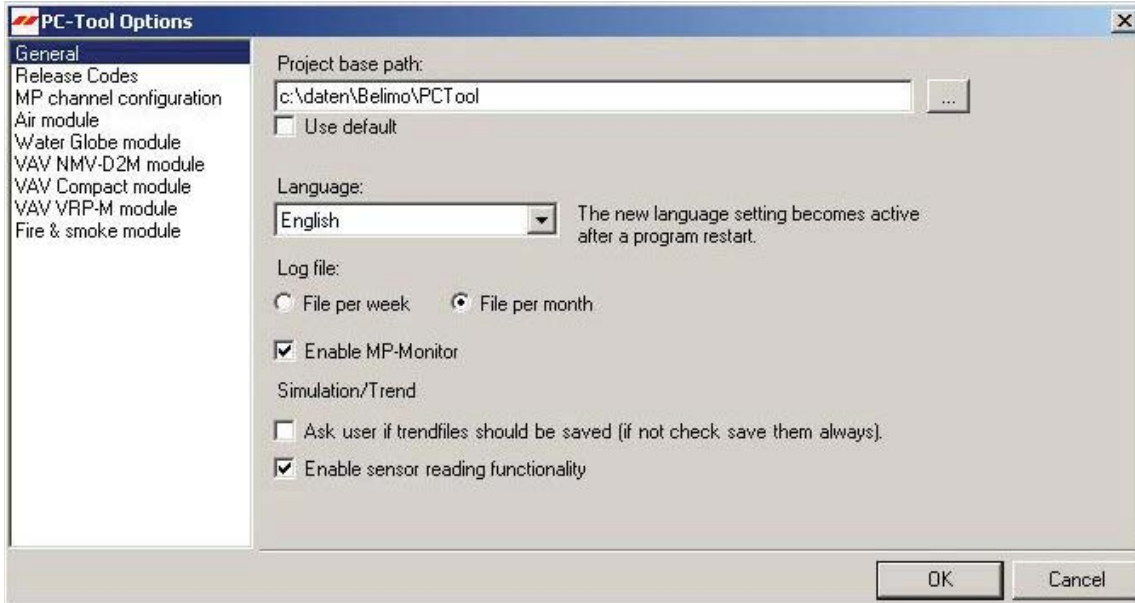

*Dialog for basic settings (general)*

"Project base path" sets the default directory in the file system, in which the new project folder will be saved. You can override this information when creating new projects, however.

When you mark the "Use default", checkbox, new projects will be saved in your user profile under "My Documents". With the operating system Microsoft Windows XP (English), this folder is located under

C:\Documents and Settings\<<Name>\My Documents.

You can open the folder "My Documents" with the "My Computer" icon.

The language that you select in the combobox will be used the next time that you start the program.

Under "Log file", you can define whether a separate log file should be created each month or each week.

Mark the "Activate MP-Monitor" checkbox to monitor the communication with the actuators with the diagnostic tool.

In addition to "General", the names of the supported modules (actuator families) are displayed on the left side. Further information on the module-specific settings is found in the corresponding sections of this manual.

### 3.13 Log file

All activities with the PC-Tool software that influence the data stored in the actuator are recorded in a separate log file for every project. The time of each action is logged.

#### Configuring the log file

You can create a separate log file for each week or month of a project (default: File per month). To change this setting, select Tools►PC-Tool options in the main menu. You can select either 'File per week' or 'File per month' under 'General'.



#### Reading the log file

Click the "Read log file" icon in the toolbar.

**Options** Click the project icon in the outline bar [C] with the right mouse button and select Read log file. Or select Project ►Read log file in the main menu.

Using the combo box 'Log file', you determine the file to read. The contents of the log file are displayed in a table in the top section (each action starts a new row).

By clicking a column title, you can sort the table according to the selected column. By clicking again on the same column title, the sorting direction is reversed: increasing (A-Z) or decreasing (Z-A).

#### Details

Click a table row to display details of this action in the bottom section.

You can print the text in the detail area ("Print..." button) or copy it to the clipboard ("Copy" button) and then paste it into another document.

Read logfile

Log file: M-2006-02.bptlog

Log events:					
Date/Time	Event	Position string	Type	Series no.	MP-Ad
02.02.2006 09.42:31	Read all parameter	P-10001	LF24-MFT2	00404-10097-080-09	PP
02.02.2006 09.42:31	Write all parameter	P-10001	LF24-MFT2	00404-10097-080-09	PP
02.02.2006 11.27:05	Read all parameter	P-10001	LF24-MFT2	00404-10097-080-09	PP
02.02.2006 11.31:20	Read all parameter		NMV-D2-MP	00603-30024-146-13	MP4
02.02.2006 14.42:16	Read all parameter		NMV-D2-MP	00603-30024-146-13	MP4
02.02.2006 14.43:09	Read all parameter	My position	SM24A-MP	00534-00026-142-12	PP
02.02.2006 16.05:21	Read all parameter	My position	SM24A-MP	00534-00026-142-12	PP
02.02.2006 16.05:31	Read all parameter	My position	SM24A-MP	00534-00026-142-12	PP
02.02.2006 16.09:04	Read all parameter	My position	SM24A-MP	00534-00026-142-12	PP
02.02.2006 16.09:10	Read all parameter	My position	SM24A-MP	00534-00026-142-12	PP
02.02.2006 16.36:10	Read all parameter		ΔF24I ON	00413-10019-084-08	MP1

Key	Value
Date/Time	02.02.2006 14.42:16
Event	Read all parameter
Position string	
Type	NMV-D2-MP
Series no.	00603-30024-146-139
MP-Adresse	MP4
Project name	testproj_tmp
-----	
SN	00603-30024-146-139
Type	NMV-D2-MP
Designation	
Position	
Address	MP4
Control type	VAV-CAV
Calibration value	3628
Volumetric flow setting	V'nom: 3303 m3/h, V'mid: 1652 m3/h V'min: 0 m3/h, V'max: 3303 m3/h
CAV feature	Standard
Control function Y	DC 2-10 V
Sensitivity	normal

Copy    Print...    Close

IM40035 - 05/10 - Subject to change. © Belimo Aircontrols (USA), Inc.

## 4 Attachment

---

### 4.1 Storage locations of files

#### 4.1.1 Project data

The default project is stored as a "Default project" sub-directory in the installation directory of the program.

The projects are user-specific and are stored as a sub-directory in the user profile. For an English-language version of Windows, this is

```
C:\Documents and Settings\<>Name>\My Documents\Belimo\PCTool
```

This directory contains sub-directories with the project names.

#### 4.1.2 Configuration files

The user-specific settings are stored in the user profile under "Application data". For an English-language version of Windows, this is

```
C:\Documents and Settings\<>Name>\Application Data\Belimo\PCTool
```

This directory can be "hidden" under Windows. If it is not present, the settings will be queried upon starting.

## 4.2 Configuration files for printing labels

### 4.2.1 Storage location

The filenames have the extension \*.bptlb. They are saved in the "label definition" directory for each project. For an English-language version of Windows, this is

```
C:\Documents and Settings\\My Documents\Belimo\PCTool\ <Project>\label definition
```

### 4.2.2 Format

The configuration files for label printing are stored in XML format. You can edit these files with an editor program, for example "Notepad".

Configuration files for common Avery and Zweckform labels are supplied with the program.

Example of a configuration file

```
<?xml version="1.0" encoding="utf-8"?>
<LabelDefinition xmlns:xsd="http://www.w3.org/2001/XMLSchema"
xmlns:xsi="http://www.w3.org/2001/XMLSchema-instance">
  <PageSize Height="278" Width="214" />
  <PageBorder Top="18" Left="5" />
  <LabelSize Height="33" Width="100" />
  <LabelBorder Top="5" Left="5" />
  <Lines>
    <Line Text="" />
    <Line Text="{0} / {1}" />
    <Line Text="{20}" />    <Line Text="{21}" />
    <Line Text="{23}" />
    <Line Text="{41} / {42}" />
  </Lines>
</LabelDefinition>
```



### 4.2.3 Boxes

You can adapt the values for the page layout (values in millimeters) for new label formats.

<b>PageSize</b>	<b>Page size (height and width)</b>
PageBorder	Border width (top and left) = distance from the top left corner of the first label to the page border
LabelSize	Size of an individual label
LabelBorder	Label border width (top and left) = distance of the lettering from the label border

In every line element <Line>, you can insert place holders where certain project and actuator characteristics will be added during printing.

{0}	Company name (from project data)
{1}	Project name
{10}	Actuator type
{11}	OEM designation
{12}	Position
{13}	Serial number
{14}	MP address
{20}	Control type Y
{21}	Feedback signal U5
{22}	Range of rotation min – mid – max
{23}	Running time
{24}	Direction of rotation (cw /ccw)
{25}	Bus fail position
{26}	Sensitivity
{27}	Synchronization at
{28}	Torque
{29}	Nominal range
{30}	Conductance
{31}	Vnom
{32}	Vmax
{34}	Vmin
{36}	Control fct.
{37}	Mode
{40}	Printing date
{41}	Text with consecutive numbering
{42}	Freely definable text 1
{43}	Freely definable text 2
{44}	Freely definable text 3
{50}	Switching point S1 in degrees (°)
{51}	Switching point S2 in degrees (°)
{52}	Setting damper free running test

You can define up to 50 lines. The program does not check whether the lines fit on a label.

---

When you define a new configuration file in a project, this configuration will not be directly available in other projects. However, you can return to the original project folder from all projects by using the entry <Other...> in the combobox, and then use the file.

---

#### 4.2.4 Example of a label

The following example results in a label having the dimensions width x height = 50 mm x 20 mm. The example is intended for an endless label printer that prints labels of the size 50 mm x 20 mm.

The company name, the project name, the actuator type, the type of control signal and the running time are printed on the label.

This data yields the following configuration file and the subsequently displayed label:

```
<?xml version="1.0" encoding="utf-8"?>
<LabelDefinition xmlns:xsd="http://www.w3.org/2001/XMLSchema"
xmlns:xsi="http://www.w3.org/2001/XMLSchema-instance">
  <PageSize Height="20" Width="50" />
  <PageBorder Top="0" Left="0" />
  <LabelSize Height="20" Width="50" />
  <LabelBorder Top="5" Left="5" />
  <Lines>
    <Line Text="{0}" />
    <Line Text="{1}" />
    <Line Text="Type: {10}"/>
    <Line Text="{20} Running time: {23}"/>
  </Lines>
</LabelDefinition>
```

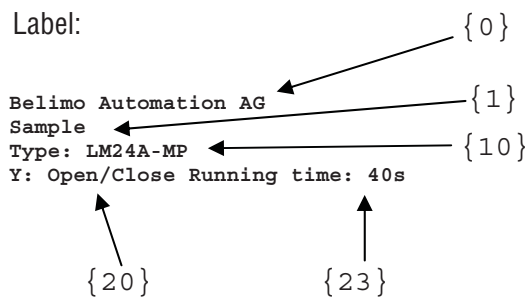

## 4.3 Troubleshooting and error messages

### 4.3.1 General

- Problem** After the program starts, an MP-Channel is not opened but displayed with the MP-Channel icon.
- Solution** The MP-Channel cannot be opened, for example because the selected serial interface is assigned to another application. Check whether a modem or a communication program is using this interface.

### 4.3.2 Error messages

Error message	Description
Start adaptation failed.	Communication failure on the MP-Channel or faulty actuator.
Actuator locked for PC-Tool.	The drive has been configured so that it can be neither read out nor programmed with the PC-Tool.
Summary: Actuator not reachable	Communication failure on the MP-Channel or faulty actuator.
Summary: Actuator run into timeout.	The drive did not respond within the specified time.
Answer has too much data.	Conflict between the actuator and program. The program library (belipp.dll) may not be up-to-date.
Answer doesn't have enough data.	Conflict between actuator and program. The program library (belipp.dll) may not be up-to-date.
Command has not enough parameters.	Conflict between actuator and program. The program library (belipp.dll) may not be up-to-date.
Command parameters out of range.	Conflict between actuator and program. The program library (belipp.dll) may not be up-to-date.
Belimo library error code = ....	Internal fault.
Description is missing	A transformation table must have a description.
Bus Jam	Two or more devices respond to the same address. Re-address the actuators.
This field is required!	This field must have an entry. It is not allowed to remain empty.
There is already an instance running!	The program cannot be started on a computer where it is already running.
Error while creating the project!	Check whether it is possible to write to the storage location of the project.
Error while copying default project.	When a new project is created, configuration files and sub-directories are normally copied from the default project in the installation directory of PC-Tool. The default project has probably been accidentally deleted, moved or renamed.

<b>Error message</b>	<b>Description</b>
Default project directory '...' does not exist! Please reinstall the application.	When a new project is created, configuration files and sub-directories are normally copied from the default project in the installation directory of PC-Tool. The default project has probably been accidentally deleted, moved or renamed.
Command ... unknown by the device	Conflict between actuator and program. The program library (belipp.dll) may not be up-to-date.
The value must be between ... and ....	The entry is not in the permitted range of values.
Invalid data answer from the device.	Conflict between actuator and program. The program library (belipp.dll) may not be up-to-date.
The difference is smaller than ....	A rule for the minimum difference between two values has been violated.
The length of the string must not exceed ... characters.	Shorten your entry.
MP-command ... unknown by PP_Function	Conflict between actuator and program. The program library (belipp.dll) may not be up-to-date.
A transformation table must have at least 2 points.	A transformation table must have at least 2 lines to be able to calculate intermediate values.
Not all parameters written to device	(Note the detailed instructions with the message regarding the reason for the error.)
Label print failed.	(Note the detailed instructions with the message regarding the reason for the error.)
Wrong device family ... instead of ...	When setting the parameters of small batches, an actuator from another actuator family was connected and does not match the parameter file.
Wrong transformation table for this sensor type. It cannot transform from unit ....	The transformation table does not have the measuring quantity of the sensor in the first column. Resistance sensors must convert 'ohm' into the target parameter, for example.
Wrong device connected!	This fault occurs when actuators are changed during parameterization. Read the parameters out again.
Wrong MP channel: '...'.	The MP-Channel has changed.

<b>Error message</b>	<b>Description</b>
Error starting testscript	The test script is invalid.
Label printing error	(Note the detailed instructions with the message regarding the reason for the error.)
Error loading transformation table	(Note the detailed instructions with the message regarding the reason for the error.)
Error while loading project file: ...	(Note the detailed instructions with the message regarding the reason for the error.)
Error reading parameter file	(Note the detailed instructions with the message regarding the reason for the error.)
Error opening Channel ....	(Note the detailed instructions with the message regarding the reason for the error.)
Error opening file explorer	File Explorer could not be started when displaying MP-Monitor files.
Error opening MP-Monitor	(Note the detailed instructions with the message regarding the reason for the error.)
Error while saving test report!	(Note the detailed instructions with the message regarding the reason for the error.)
Error while processing line ... of the trend file ...	The trend file could not be interpreted. It was probably written manually.
Error: Invalid code for the module release.	Relates to the entry of the activation code. Please check your entry. All boxes must be filled-out according to the requirements.
Error: There is another device on MP1	Address conflict.
Error: Unable to change address to MP1	Address conflict.
Error: no answer from actuator	Communication failure on the MP-Channel or faulty actuator.
Address ... already set to this device!	Re-addressing re-assigns an already existing address.
Module release code expired!	Please contact your representative for a replacement of the code.
Character '...' is not allowed (not ISO-8859-1)!	Only characters from the Western European character set are permitted for Description and Position of an actuator (see table in Section 4.3.3).
No answer (possible bus jam).	Communication problem on the MP-Channel or faulty actuator.
No answer from device.	Communication failure on the MP-Channel or faulty actuator.
No label configuration file chosen.	Please choose a valid label configuration file and print a test label or uncheck print label after write.
No or empty setup string.	"Other" was selected when setting the communication parameters, but no connection was specified.
Could not deaddress other device	Address problem. (Note the detailed instructions with the message regarding the reason for the error.)
Couldn't write to the device!	Communication failure on the MP-Channel or faulty actuator.

Error message	Description
Could not find the VRP-M Tool executable. Would you search for it now?	Concerns VRP-M controller. The corresponding program could not be found at the location specified in the PC-Tool options.  Configure the path in the options (menu Tools/PC-Tool options in VRP-M).
Could not find PC-Tool V2.1. Would you search for it now?	Affects VAV actuators. The old version of the program could not be found at the location specified in the PC-Tool options.
Error while loading project.	(Note the detailed instructions with the message regarding the reason for the error.)
MP-Command ... failed.	Conflict between actuator and program. The program library (belipp.dll) may not be up-to-date. MP command could be password-protected.
MP-Channel was closed	The MP-Channel was closed during an asynchronously running function.
Not all data written to the device.	Communication problem during writing of the parameter data, possibly due to bus jam. Check the connection and addressing of the actuators. An MP command is password-protected or the actuator is not familiar with the command.
Could not read all data from the device.	Communication problem while the parameter data was read, possibly due to bus jam. Check the connection and addressing of the actuators.
Not all fields have valid values! Can't write data	One or more input values in the "Configuration" tab is not valid. Look for a flashing exclamation mark. If you move the mouse pointer to the exclamation mark, an explanatory text (tooltip) with the valid range of values will usually appear.
OEM or BELIMO password necessary. Please contact OEM-Manufacturer	Parameters on the actuator can be protected with a password against changes. A password is necessary to overwrite them.
Parameter file contains no series number	When setting the parameters of small batches, the actuator family is checked by means of the serial number. The parameter file is old or has been changed manually.
Error opening configuration file	(Note the detailed instructions with the message regarding the reason for the error.)
Error storing configuration file	(Note the detailed instructions with the message regarding the reason for the error.)
Plausibility check: Failed. Please check the configuration dialog for further information.	Testing is not started if there are errors in the configuration.
Problems opening the MP-Channel "...".	Error at the interface. Check the communication parameters and the cabling.
Sending ... to ... returned error ...	Conflict between actuator and program. The program library (belipp.dll) may not be up-to-date.
Wrong format of serial number	You have made a typing error while manually entering the serial number. Check the notation of the serial number.

<b>Error message</b>	<b>Description</b>
Series number has a wrong format!	You have made a typing error while manually entering the serial number. Check the notation of the serial number.
Reset alarm messages failed	Communication failure on the MP-Channel or faulty actuator.
Synchronization failed	Communication failure on the MP-Channel or faulty actuator.
The test script cannot be started because some conditions are not complied.	A certain minimum air flow or system pressure is necessary for the test. Please check fan and VAV box.
Start test run failed	Communication failure on the MP-Channel or faulty actuator.
New address could not be verified	The serial number is read before and after an actuator is re-addressed. These two numbers do not match. Another actuator probably answers to the programmed address.
Unknown MP-Channel '...'	The MP-Channel could not be identified.
Invalid or corrupted parameter file '...'	The contents of the file could not be correctly interpreted. The format may no longer be valid. If possible, read out the parameters again and save them in a new file.
Invalid Series Number	The entered serial number was not found in any connected actuator.
Invalid value entered	Refer to the notes about the valid range of values.
Invalid value!	Refer to the notes about the valid range of values.
Unspecific Belimo-Lib error	Internal fault.
Must be greater than zero.	Refer to the notes about the valid range of values.
Must be an integer.	Refer to the notes about the valid range of values.
Summary: Test cannot be executed due to active forced control	Remove the Y connection with the control signal for the duration of the test.
Two or more devices respond to the same address.	Bus jam Re-address the actuators.



### 4.3.3 ISO 8859-1/ANSI character set

Only characters from the ISO 8859-1/ANSI character set are permitted in the "Description" and "Position" box











Pos	Char	Pos	Char	Pos	Char	Pos	Char	Pos	Char	Pos	Char	Pos	Char
32		64	@	96	`	128	€	160	<sup>7)</sup>	192	À	224	à
33	!	65	A	97	a	129	•	161	ı	193	Á	225	á
34	"	66	B	98	b	130	, <sup>1)</sup>	162	ç	194	Â	226	â
35	#	67	C	99	c	131	f	163	£	195	Ã	227	ã
36	\$	68	D	100	d	132	„ <sup>2)</sup>	164	¤	196	Ä	228	ä
37	%	69	E	101	e	133	...	165	¥	197	Å	229	å
38	&	70	F	102	f	134	†	166	‡	198	Æ	230	æ
39	'	71	G	103	g	135	‡	167	§	199	Ç	231	ç
40	(	72	H	104	h	136	^	168	¨	200	È	232	è
41	)	73	I	105	i	137	‰	169	©	201	É	233	é
42	*	74	J	106	j	138	Š	170	ª	202	Ê	234	ê
43	+	75	K	107	k	139	‹	171	«	203	Ë	235	ë
44	,	76	L	108	l	140	Œ	172	¬	204	Ì	236	ì
45	-	77	M	109	m	141	•	173	- <sup>8)</sup>	205	Í	237	í
46	.	78	N	110	n	142	Ž	174	®	206	Î	238	î
47	/	79	O	111	o	143	•	175	™	207	Ï	239	ï
48	0	80	P	112	p	144	•	176	°	208	Ð	240	ð
49	1	81	Q	113	q	145	‘ <sup>3)</sup>	177	±	209	Ñ	241	ñ
50	2	82	R	114	r	146	’ <sup>4)</sup>	178	²	210	Ò	242	ò
51	3	83	S	115	s	147	“ <sup>5)</sup>	179	³	211	Ó	243	ó
52	4	84	T	116	t	148	” <sup>6)</sup>	180	´	212	Ô	244	ô
53	5	85	U	117	u	149	•	181	µ	213	Õ	245	õ
54	6	86	V	118	v	150	–	182	¶	214	Ö	246	ö
55	7	87	W	119	w	151	—	183	·	215	×	247	÷
56	8	88	X	120	x	152	~	184	¸	216	Ø	248	ø
57	9	89	Y	121	y	153	™	185	¹	217	Ù	249	ù
58	:	90	Z	122	z	154	š	186	º	218	Ú	250	ú
59	;	91	[	123	{	155	›	187	»	219	Û	251	û
60	<	92	\	124		156	œ	188	¼	220	Ü	252	ü
61	=	93	]	125	}	157	•	189	½	221	Ý	253	ý
62	>	94	^	126	~	158	ž	190	¾	222	Þ	254	þ
63	?	95	_	127		159	ÿ	191	¿	223	ß	255	ÿ

The character positions marked with • are vacant.

- 1) Single speech mark, low
- 2) Double speech marks, low
- 3) Single left speech mark
- 4) Single right speech mark
- 5) Double left speech marks
- 6) Double right speech marks
- 7) Non-breaking space
- 8) Breaking hyphen

## 4.4 Typical wiring diagrams

### 4.4.1 Overview table

Cable	MP level converters and devices	Drawing	Page
<b>ZK1-GEN</b> 	 <b>ZIP-USB-MP</b>	Typical wiring diagram 1	1-55
<b>ZK2-GEN</b> 	 <b>ZIP-USB-MP</b>	Typical wiring diagram 2	1-55
		Typical wiring diagram 3	1-56
<b>ZK6-GEN</b> 	 <b>ZIP-USB-MP</b>	Typical wiring diagram 4	1-56
<b>ZKS-MP</b> 	 <b>ZIP-USB-MP</b>	Typical wiring diagram 5	1-57
<b>ZK1-VAV</b> 	 <b>ZIP-USB-MP</b>	Typical wiring diagram 6	1-57
		Typical wiring diagram 7	1-58
<b>Direct connection</b>	 <b>ZIP-RS232</b>	Typical wiring diagram 8	1-58

IM40035 - 05/10 - Subject to change. © Belimo Aircontrols (USA), Inc.

4.4.2 Typical wiring diagrams

Typical wiring diagram 1

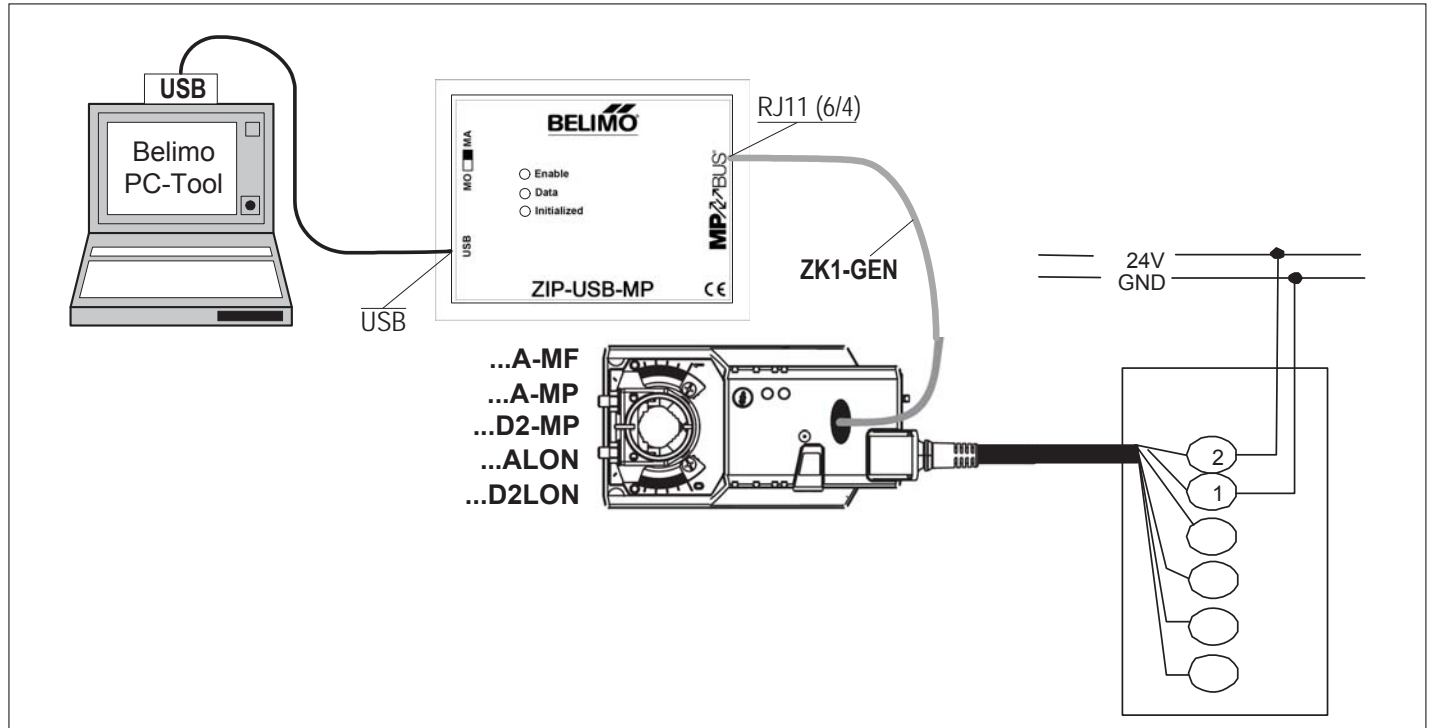

Typical wiring diagram 2

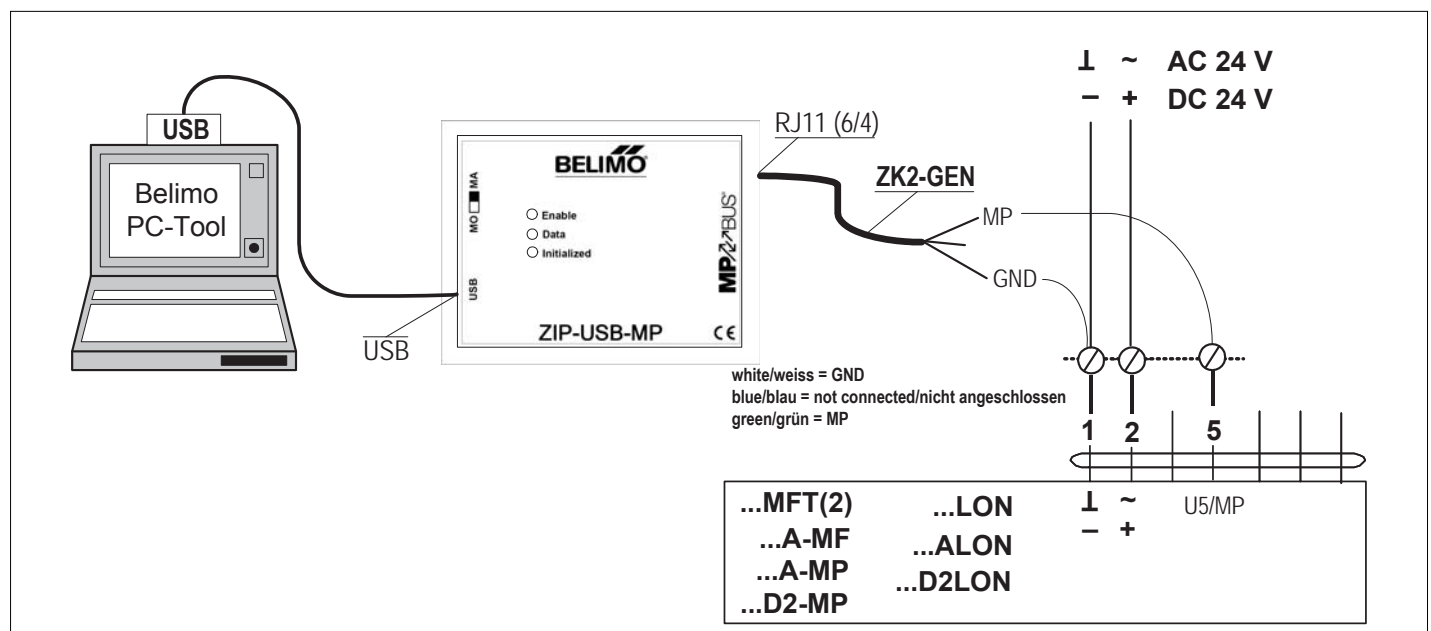

M40035 - 05/10 - Subject to change. © Belimo Aircontrols (USA), Inc.

Typical wiring diagram 3

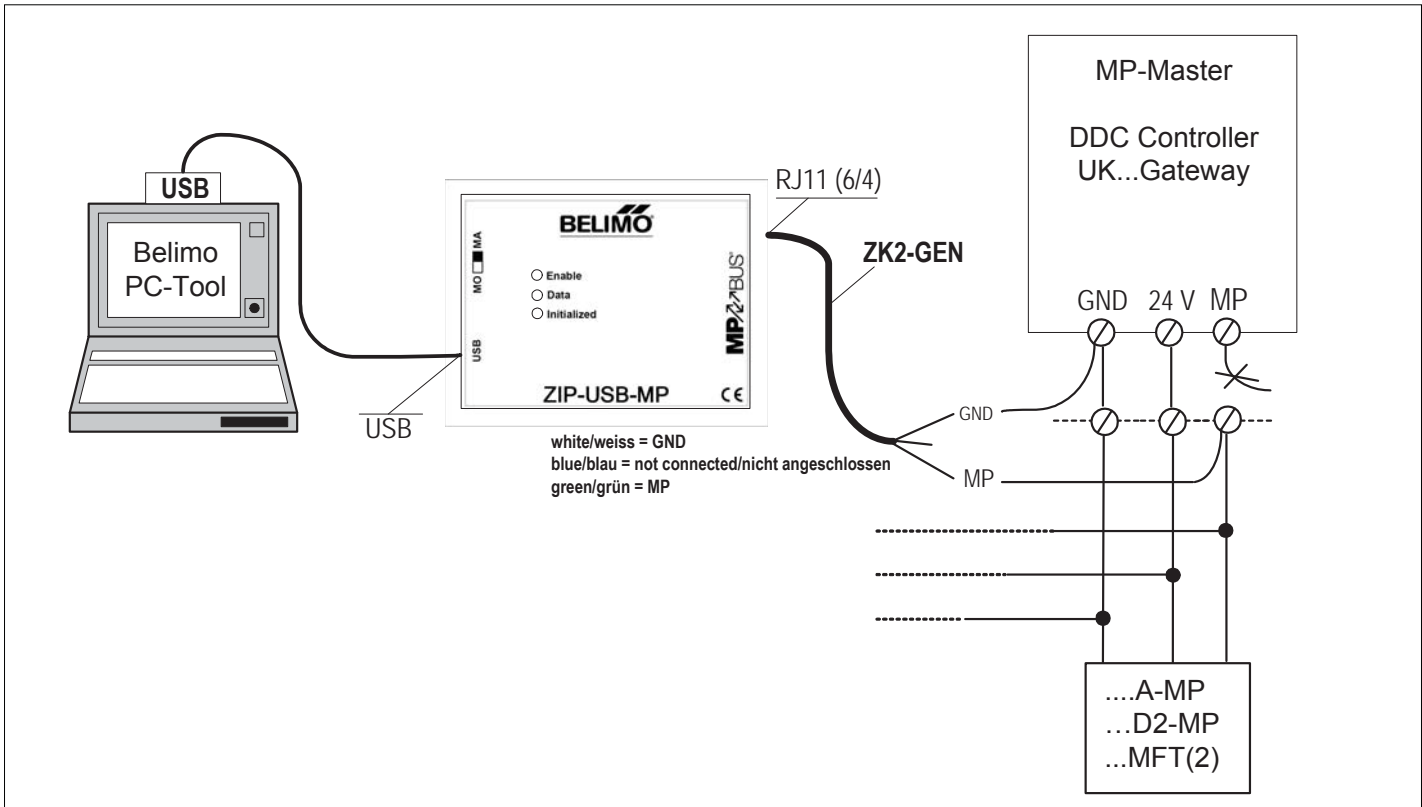

Typical wiring diagram 4

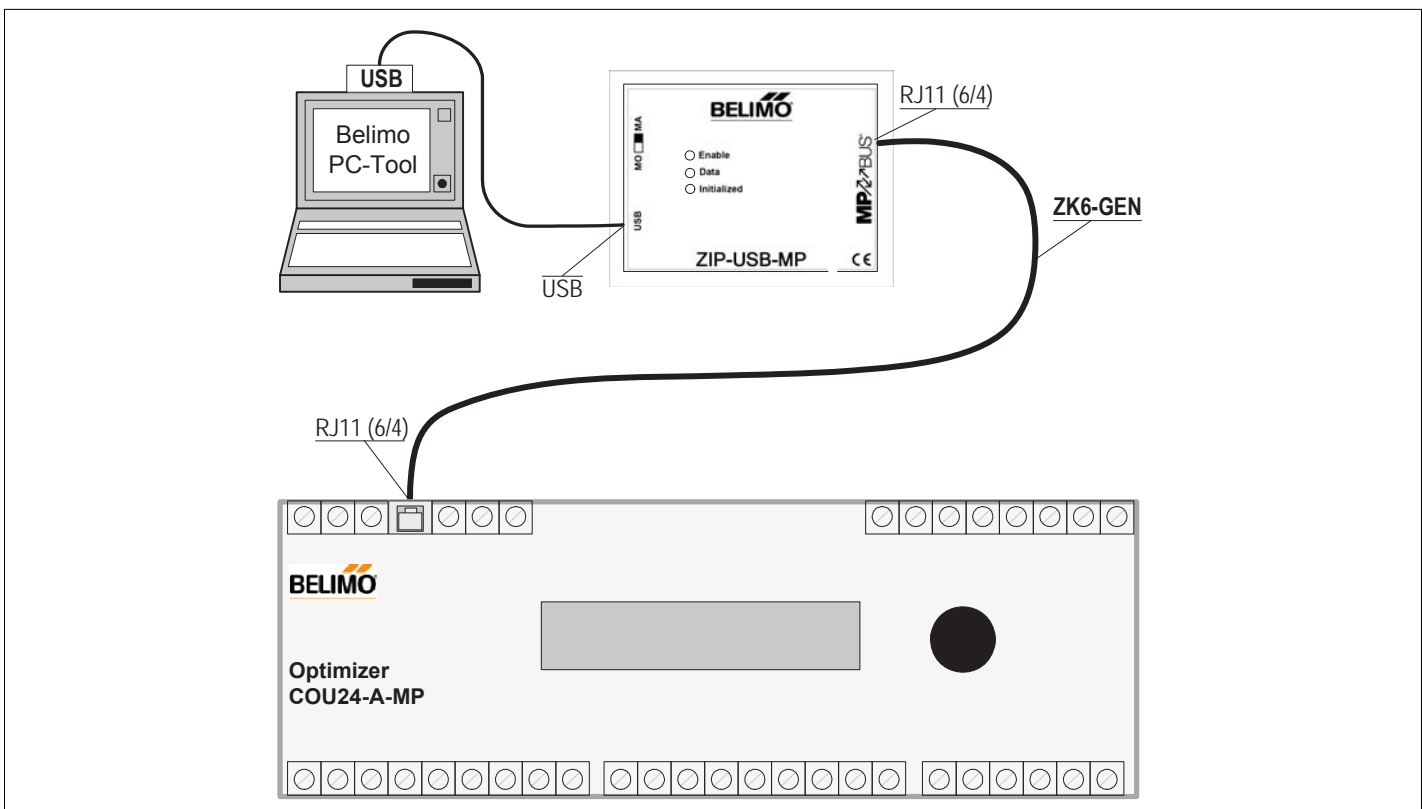

IM40035 - 05/10 - Subject to change. © Belimo Aircontrols (USA), Inc.

Typical wiring diagram 5

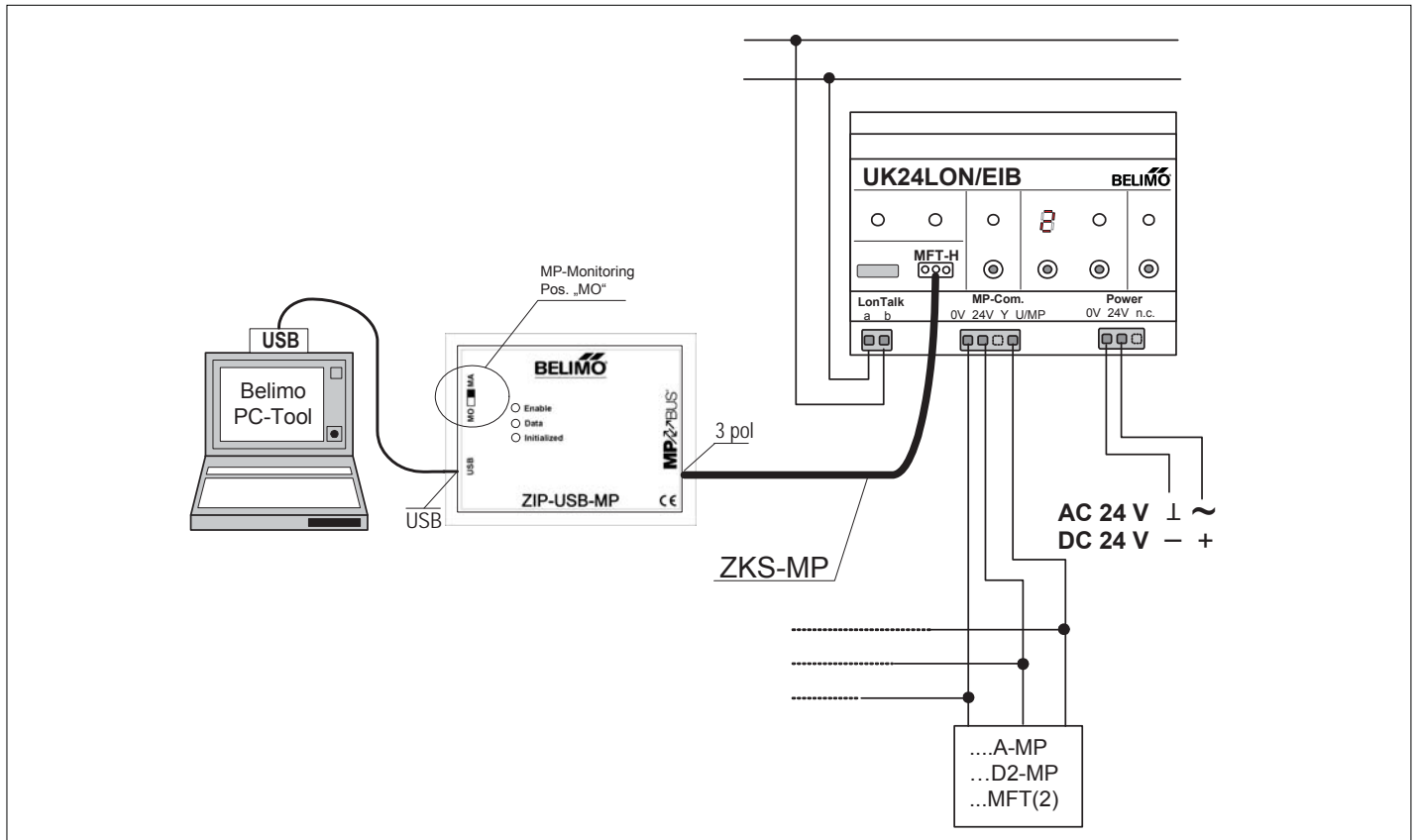

Typical wiring diagram 6

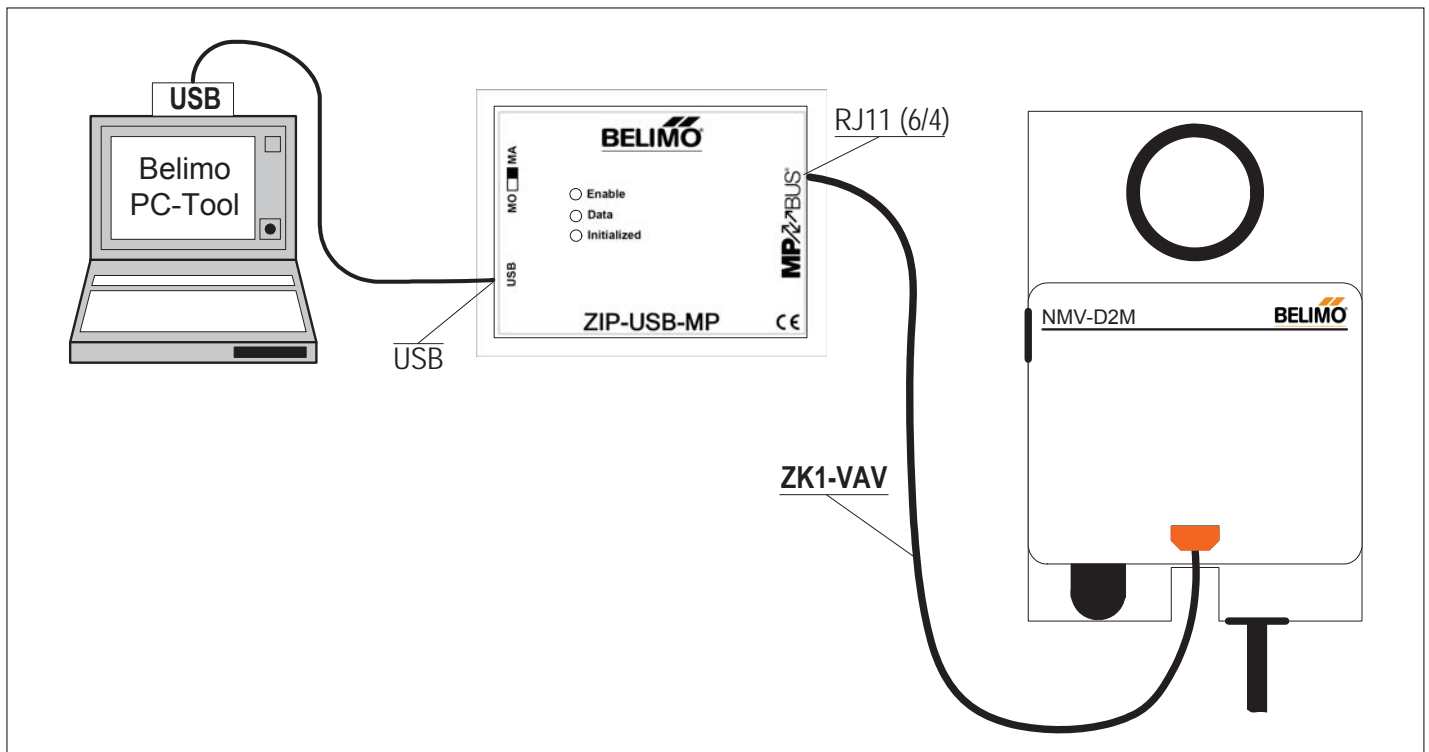

M40035 - 05/10 - Subject to change. © Belimo Aircontrols (USA), Inc.

Typical wiring diagram 7

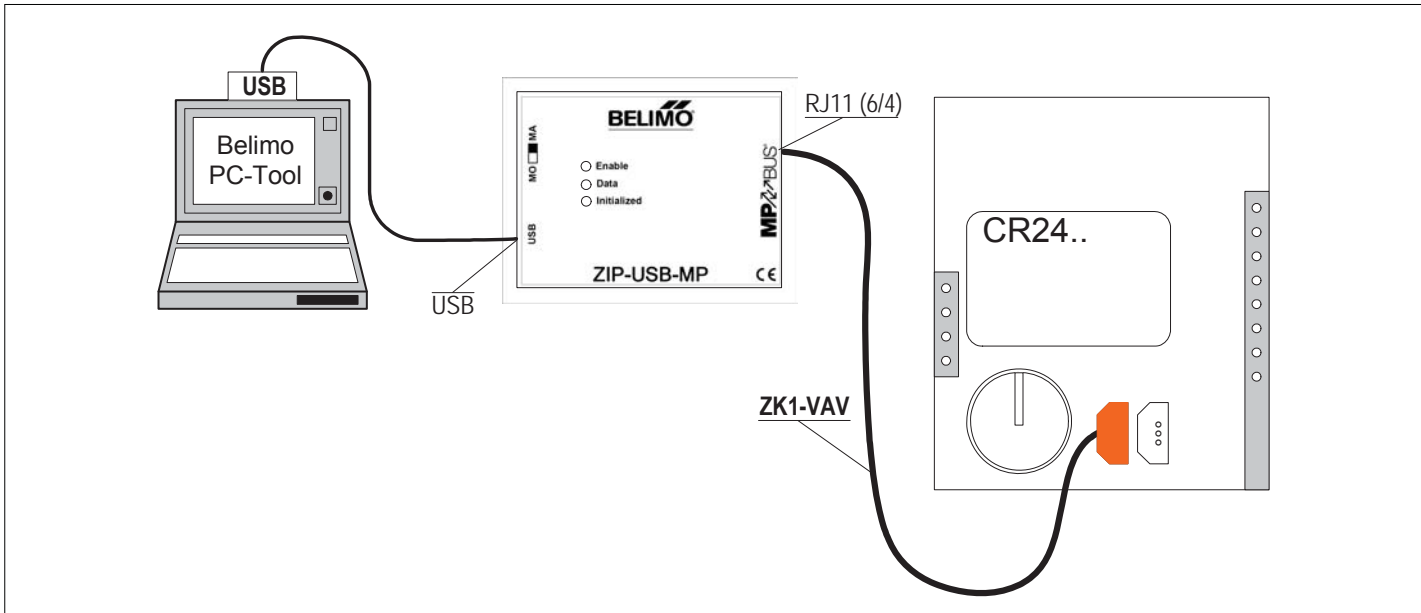

Typical wiring diagram 8

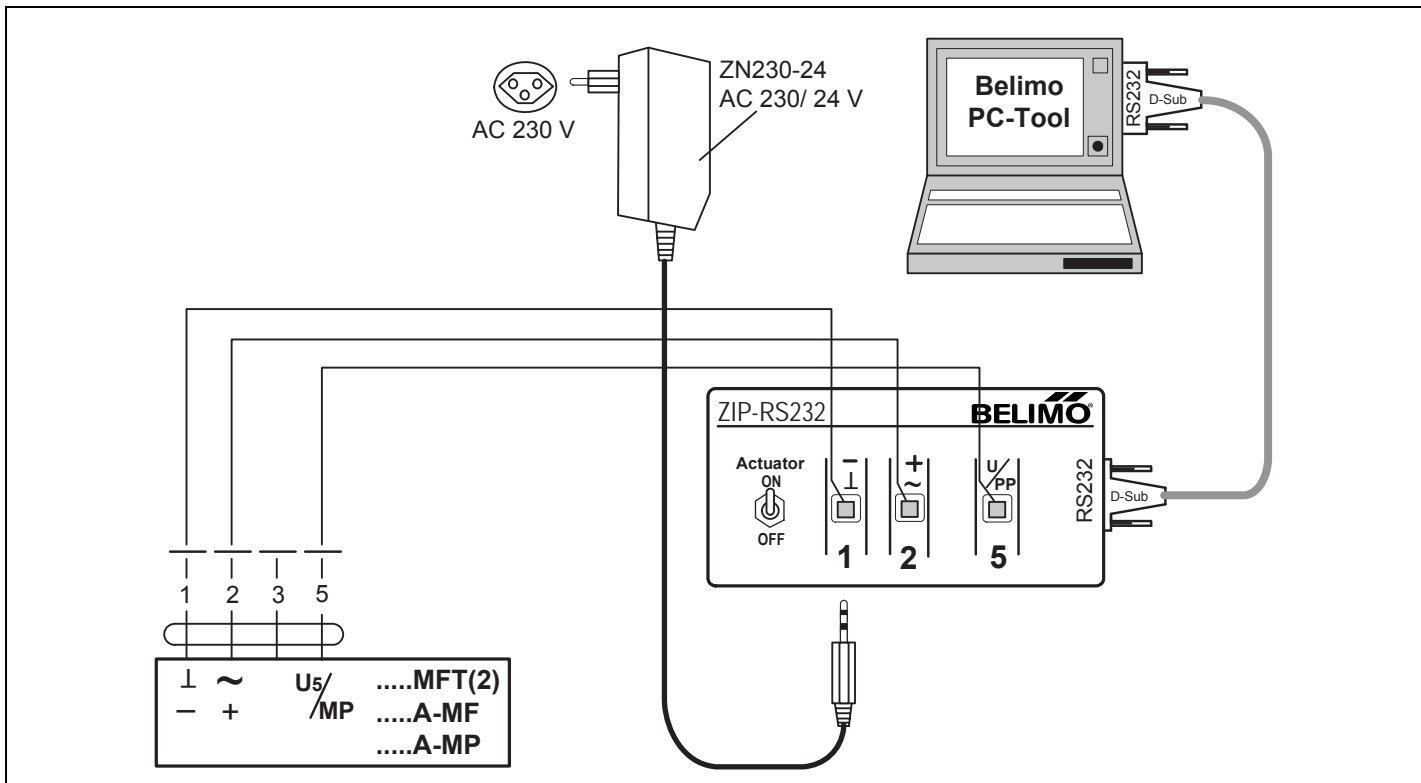

IM40035 - 05/10 - Subject to change. © Belimo Aircontrols (USA), Inc.

# Damper and Valve Actuators User Manual

M40035 - 05/10 - Subject to change. © Belimo Aircontrols (USA), Inc.





## Table of Contents

<b>1</b>	<b>Introduction .....</b>	<b>2-1</b>
<b>2</b>	<b>Service.....</b>	<b>2-2</b>
2.1	Displaying settings .....	2-2
2.2	Adaptation .....	2-4
2.3	Synchronization .....	2-4
2.4	Function test.....	2-5
<b>3</b>	<b>Configuration .....</b>	<b>2-7</b>
<b>4</b>	<b>Controller simulation .....</b>	<b>2-14</b>
4.1	Actuator control.....	2-15
4.2	Reading out sensors and switches .....	2-15
4.3	Trend recording .....	2-16
<b>5</b>	<b>PC-Tool options .....</b>	<b>2-18</b>



# 1 Introduction

---

The "Air module" user manual describes the detail area [D] of the Air module. The documentation is divided according to the three index tabs "Service", "Configuration" and "Simulation".

Air and Water Actuators are basically the same. The water actuator has a linkage that connects the actuator to the valve. The nomenclature of air and water is as follows:

<b>Air</b>	<b>Water</b>
GMB	GRB
AMB(Q)	ARB
NMB(Q)	NRB
LMB(Q)	LRB

The actuators operate in the same manner. Examples in this document show the damper versions and all data applies to valve actuators as well.

NOTE: NV/NVF actuators section starts on 3-A

## 2 Service

NOTE: This will display after successfully communicating to the actuator.

### 2.1 Displaying settings

The Service tab gives an overview of the current settings of the actuator.

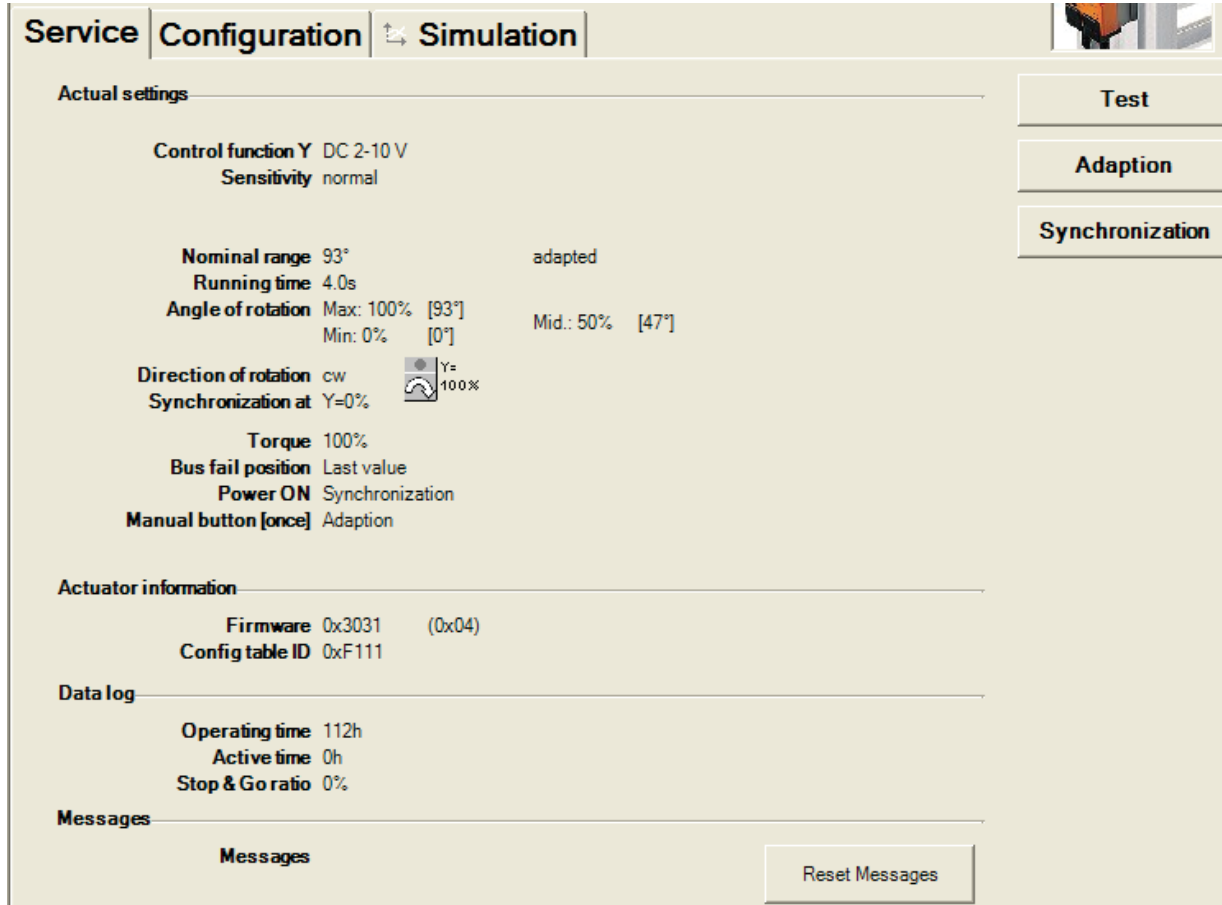

*Service tab for full-rotation damper actuators*

For linear actuators the stroke is displayed instead of the angle of rotation, and the torque instead of the positioning force.

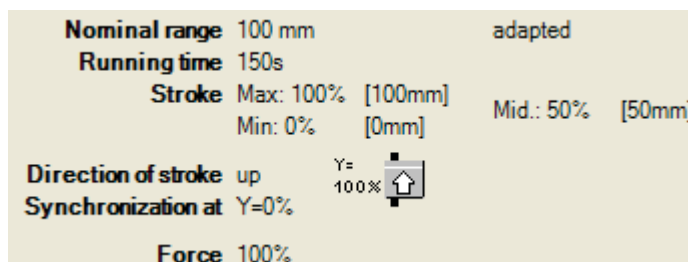

*Service tab for linear actuators (excerpt)*

### Meaning of the settings

Control signal Y	Type of control
Sensitivity	Response sensitivity and reversal hysteresis of the control function
Feedback U5	Type of feedback signal
Range	Position range within the mechanical limits
Running time	related to operating range or a fixed angle/stroke of 95°/100mm (with annotation)
Angle of rotation	Programmed rotation range: Min / Mid / Max (for full-rotation actuators)
Stroke	Programmed stroke range: Min / Mid / Max (for linear actuators)
Direction of rotation	Clockwise/counterclockwise (for full-rotation actuators)
Direction of stroke	Up / down (for linear actuators)
Synchronization at	Stop position 0 % or 100 %
Torque	In percent of the maximum torque (for full-rotation actuators)
Actuating force	In percent of maximum positioning force (for linear actuators)
Behavior in the event of bus failure	Behavior when communication fails
Power ON	Behavior when the system is switched on
Manual button [once]	Function when pressed once
Manual button [twice]	Function when pressed twice (not present in "New Generation" actuators)
Function table	Assignment of override setting and override function (only for certain actuators)
Firmware	Software version on the actuator
Config table ID	Identification of the configuration table
Operating time	Number of hours during which the actuator was connected to the power supply
Active time	Number of hours during which the actuator was mechanically in motion and connected to the power supply
Stop & Go ratio	Ratio of active time/operating time in percent. A high Stop & Go ratio indicates an unstable control.

## 2.2 Adaptation

In the adaptation, the actuator determines the range 0% ... 100% by approaching the mechanical limits.

Click the "Adaptation" button on the Service tab.

**Option** You can also trigger the adaptation directly on the actuator. The necessary buttons for this can be programmed. For example, "Manual button [twice]" can be assigned the adaptation function.

The progress of the adaptation is displayed in the status line. The actuator first moves against the programmed direction to the zero stop and then to the end stop at the full angle of rotation.

Next, the absolute values for a programmed limited angle of rotation range (minimum, mid-position, and maximum) as well as the feedback signal U5 are recalculated and displayed.

## 2.3 Synchronization

In the case of synchronization, a mechanical limit is moved to in order to determine the absolute range.

For each actuator, it is possible to program whether synchronization will take place at the zero stop (0%) or at the full angle of rotation/stroke (100%).

Click the "Synchronization" button on the Service tab.

**Option** You can also trigger the synchronization directly on the actuator. The necessary buttons for this can be programmed. For example, "Manual button [once]" can be assigned the synchronization function.

The progress of the synchronization is displayed in the status line. With the setting Synchronization at: Y=0%, the actuator moves against the programmed direction to the zero stop, and with the setting Synchronization at: Y=100% to the end stop at the full angle of rotation/stroke.

### Function test

The function test checks for opening and closing.

First of all, the drive moves to the mechanical stop according to the synchronization position. If the angle of rotation (or stroke) is set to "adapted", movement takes place to the other stop; with "programmed", on the other hand, to the programmed range limit.

Click the "Test" button on the Service tab. The standard display is covered by the test window.

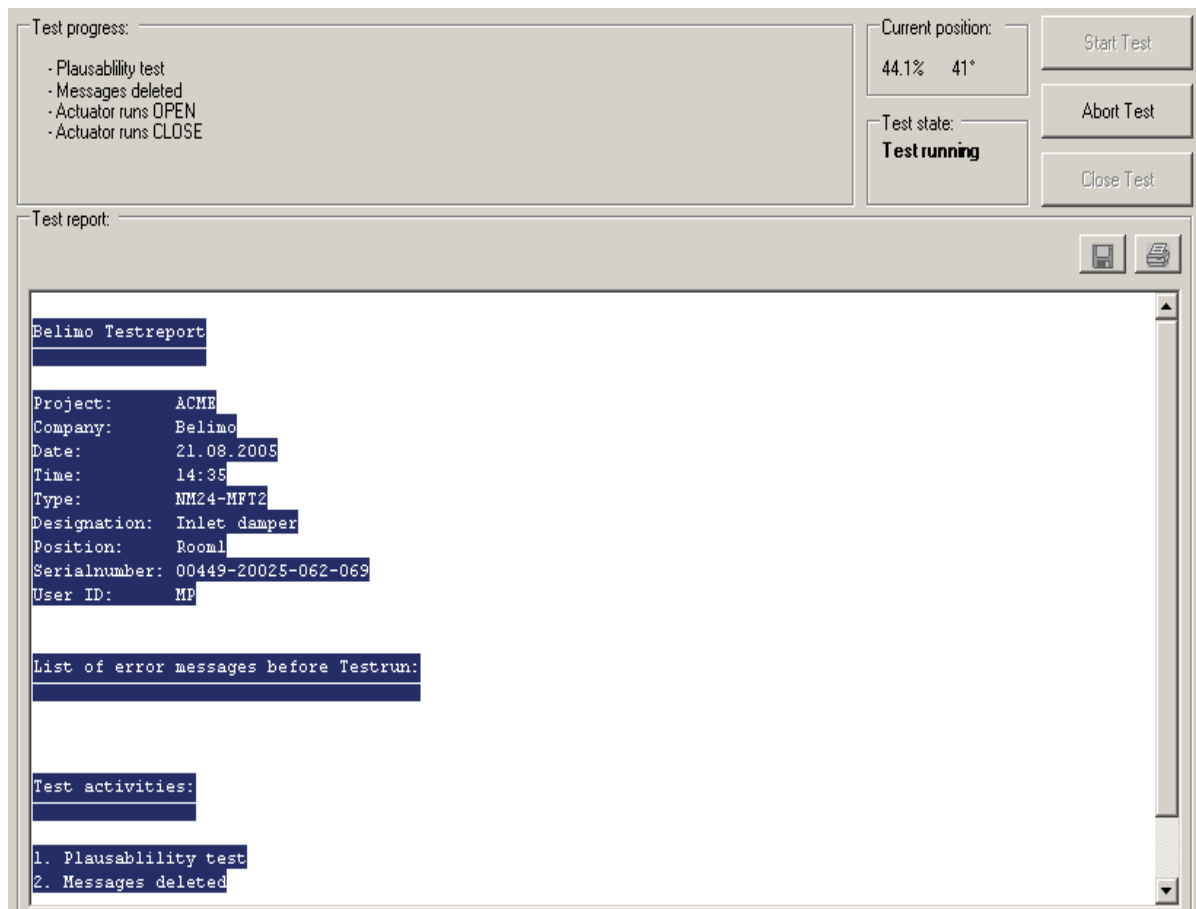

*Display of test progress and test report*

Click the "Start Test" button.

The progress and the current position are continuously displayed.

The test report contains

- information on the project,
- the identification of the actuator,
- a list of fault messages pending before the start of the test,
- the test steps and the test results, and
- the current actuator settings.

---

If the test reports an invalid actuator configuration, go to the "Configuration" tab after ending the test. The values that are not allowed are marked with a flashing exclamation point.

---

You can save the test report as a file by clicking the floppy disk icon, and you can print it with the printer icon.

End the function test with the "Close Test" button. The program asks whether you want to save an unsaved test report now.

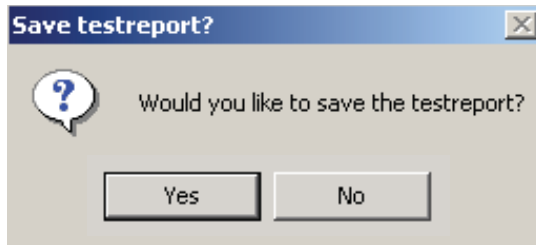

If you cancel the test early, the actuator will be reset to its original state. No test report will be created.



### 3 Configuration

On the "Configuration" tab, you can read out parameter values from the actuator, change them and save them back to the actuator. The valid ranges for the parameter values are displayed in parentheses next to the input boxes.

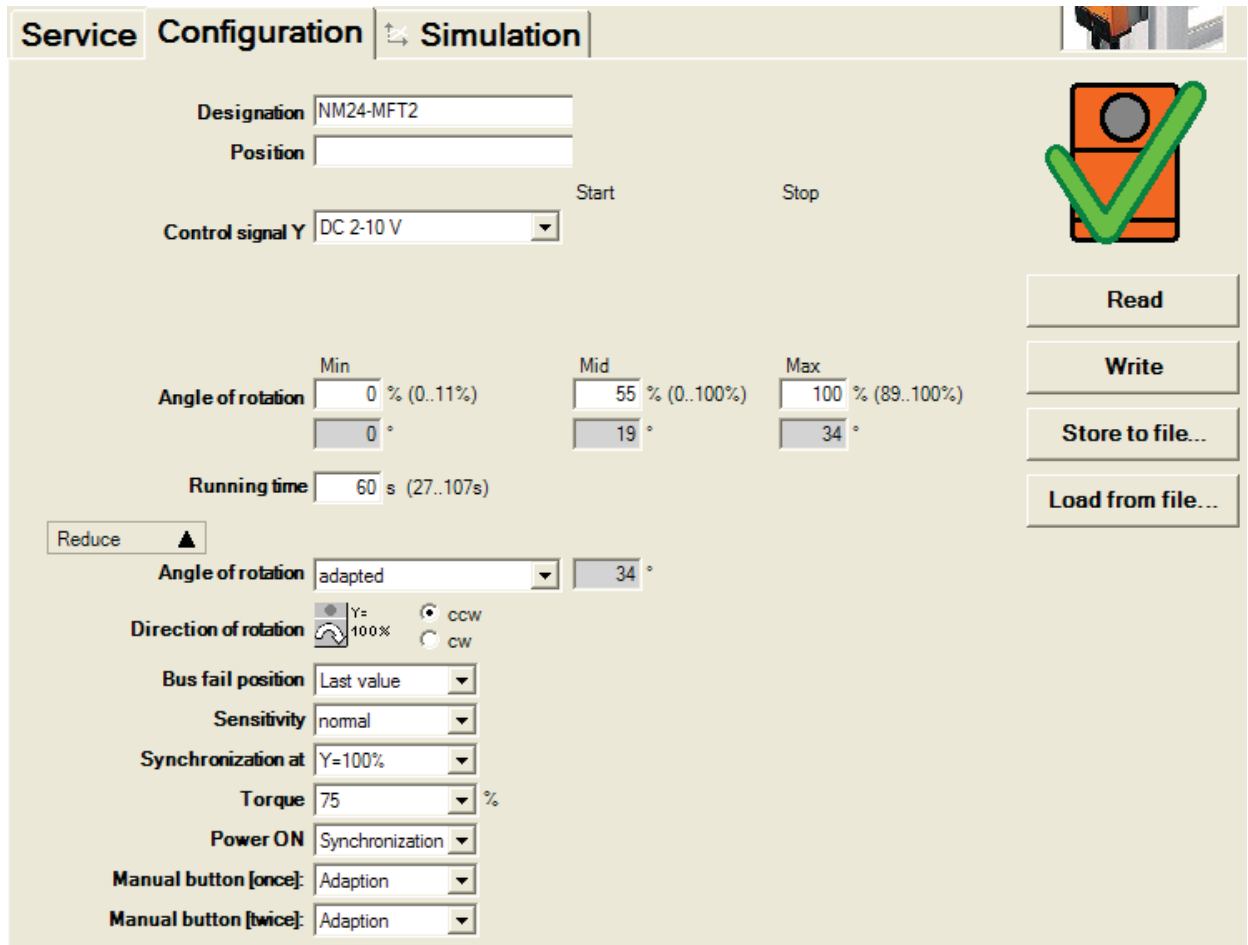

"Configuration" tab for full-rotation damper actuators

For linear actuators, the stroke is displayed instead of the angle of rotation and the stroke direction instead of the direction of rotation.

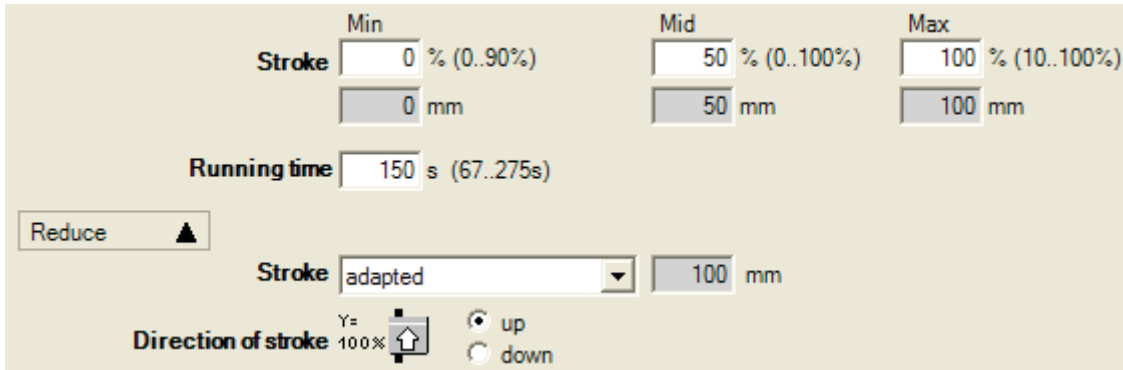

"Configuration" tab for linear actuators (excerpt)

Actuator number

Description	16 characters of any text
Position	16 characters of any text

Control signal Y

3-point	AC voltage, positions: Open / neutral / closed
Open / closed	DC or AC voltage, 2-point
DC 0–10 V	(DC voltage) Fixed operating range DC 0–10 V
DC 2–10 V modulating	(DC voltage) Fixed operating range DC 2–10 V
DC variable	Start (Y=0%) 0.5 ... 30 V Stop (Y=100%) 2.5 ... 32 V Range between start and stop at least 2 V
PWM 0.02–5 s	Duration of the control pulse (pulse width modulation), fixed operating range
PWM 0.1–25.5 s	Duration of the control pulse, fixed operating range
PWM 0.59–2.93 s	Duration of the control pulse, fixed operating range
PWM variable	Start (Y=0%) minimum 0.02 seconds Stop (Y=100%) maximum 50 seconds

VAV 4 +/- 6 V	When this function is selected, the actuator is parameterized as a VAV actuator and can therefore be controlled by the VAV controllers VR...  Note: When VAV (6 ± 4 V) is selected, the values for minimum, maximum, intermediate value, running time and angle of rotation/stroke are reset to the default values.
4–20 mA	(Direct current) Fixed operating range DC 4–20 mA  Note: This selection is only available for certain drives (e.g. "SunYeh")
mA variable	(Direct current) The values for start and stop are specified in the actuator and cannot be changed with the PC-Tool.  Note: This selection is only available for certain drives (e.g. "Butterfly Actuators")

Feedback U5 (only active when the actuator address is set to PP)

Damper position, 2–10 V	DC voltage measurement signal, fixed range
Damper position, 0.5–10 V	DC voltage measurement signal, fixed range
Damper position, variable	DC voltage measurement signal Start 0.5...8.0 V / Stop 2.5 ... 10.0 V Range between start and stop at least 2 V
Damper position, 4–20 mA	Direct current measurement signal, fixed range
...	<i>Certain actuators can define further feedbacks, which you cannot change, however.</i>

U5 scaling (only with "New Generation" actuator, MFT or MP types)

Start	Position in percent, corresponds to the start value of the feedback signal
Stop	Position in percent which corresponds to the stop value of the feedback signal

Angle of rotation (for full-rotation actuators)

Stroke (for linear actuators)

Min	Programmed lower limit of the range
Mid	Mid-position of range
Max	Programmed lower limit of the range

An existing value for Mid is automatically adapted when Min and Max are entered: If you enter Min, Mid is always larger than or equal to this input value. If you enter Max on the other hand, Mid is always less than or equal to this value.

Examples of settings for control signal Y / feedback U5

**Control signal Y:** 3...8 V min: 30%, max : 70%  
**Feedback U5 :** 2...7 V start: 20%, stop: 90%

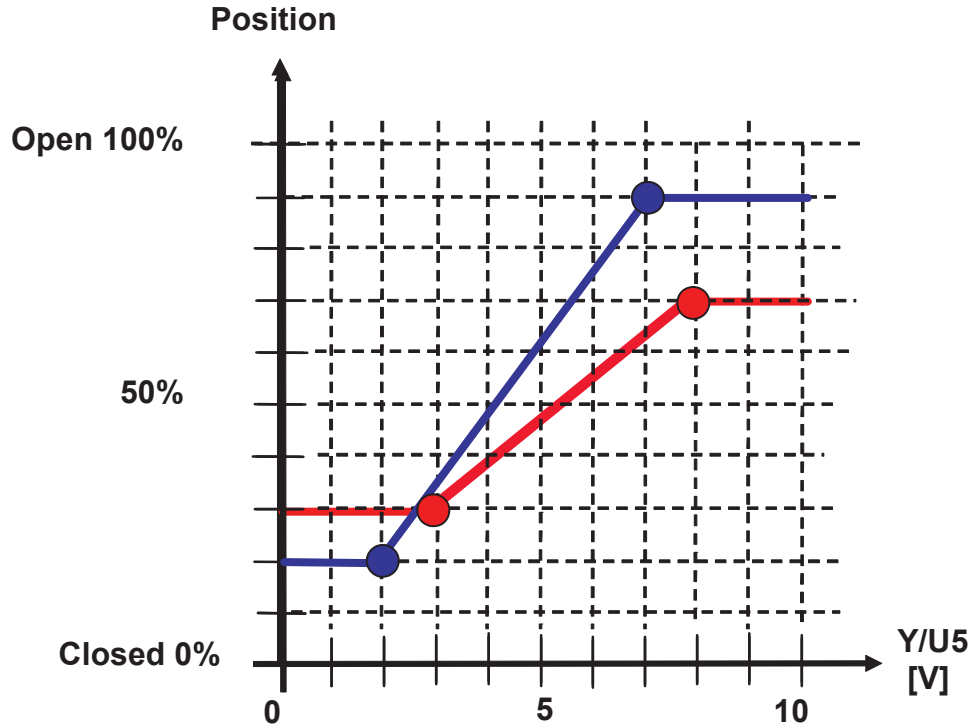

Running time

In seconds	Time needed to pass through the range limited by Min and Max (the valid range of values for the running time depends on the actuator type and the passed-through range).
------------	--

Note: For actuators with the "constant speed" operating mode, the speed does not depend on the range passed through. The running time refers to a fixed angle of 95° for rotary actuators or a fixed stroke of 100 mm for linear actuators.

Angle of rotation (for full-rotation actuators) / Stroke (for linear actuators)

Adapted	from the mechanical limits of certain angle of rotation range/stroke
Programmed	Angle of rotation range (full-rotation) or stroke (linear), the valid values depend on the maximum nominal setting range of the actuator

Direction of rotation (for full-rotation actuators)

cw	Damper opening in the clockwise direction
ccw	Damper opening in counterclockwise direction

Stroke direction (for linear actuators)

open	Upward-opening damper (relative to the orientation of the lettering on the actuator)
down	Downward-opening damper

Behavior in the event of bus failure

Last setpoint	Position according to control signal Y
Open	Move to full angle of rotation/stroke (100 %)
Close	Move to zero stop
Close quickly	Close with maximum speed

Sensitivity

Sensitivity	Actuators without spring-return: NM24-MFT AM24-MFT GM24-MFT	Actuators with spring return: TF24-MFT LF24-MFT NF24-MFT AF24-MFT	Actuators of the new generation and linear: ..MF ..MP ..LON
Normal			
– Response sensitivity:	1° angle of rotation	1° angle of rotation	1.0% @ operating range
– Reversal hysteresis	2.5° angle of rotation	2.5° angle of rotation	2.5% @ operating range
Damped			
– Response sensitivity:	2° angle of rotation	2° angle of rotation	2% @ operating range
– Reversal hysteresis	5° angle of rotation	5° angle of rotation	5% @ operating range
Variable (only available with release code)			
– Response sensitivity	--	--	adjustable 0% ... 20%
– Reversal hysteresis	--	--	adjustable 0% ... 20%

Synchronization at

Y = 0%	Moves to the mechanical limit at zero stop (depending on the direction of rotation / stroke direction)
Y = 100%	Moves to the mechanical limit at full angle of rotation (depending on direction of rotation / stroke direction)

Note: When the nominal setting range is set to "programmed", then the synchronization MUST be carried out at Y=0%.

Torque (for full-rotation actuators) / Positioning force (for linear actuators)

25% ... 100%	Can be set in increments of 25%. 100% corresponds to the maximum torque / the maximum positioning force for the actuator type (see nameplate)
--------------	---

Power ON

Synchronization	Moves to a mechanical limit (according to the setting "Synchronization at")
Adaptation	Moves to both mechanical limits and recalculates angle-dependent parameters
Nothing	(This option is not available for actuators of the "TOP" performance class. When switched on, they must always be adapted or synchronized)

You can programmatically limit the rotation and stroke range at one end by only changing the minimum or the maximum. If the value of Power ON is set to "Nothing", then the following holds true:

*The mechanical limit that can still be attained within a rotation range limited at one end will be used for synchronization.*

If you set the minimum to a value greater than 0%, the zero stop will no longer be in the range. In this case, synchronization will take place at the end stop of the full damper opening (Y = 100%). If, on the other hand, you set the maximum to a value smaller than 100%, synchronization will take place at the zero stop (Y = 0%).

This is also valid for the case that the nominal setting range is set to "programmed" and the minimum is equal to 0%: The setting "Power ON: Nothing" is allowed.

Synchronization when the angle of rotation/stroke is limited at both ends

If the minimum is greater than 0% AND the maximum is smaller than 100%, then you can select where the synchronization will take place. In this case, it is necessary to perform synchronization or adaptation when you switch the device on (the setting "Power ON: Nothing" is considered an error).

If the nominal setting range is set to "programmed" and the minimum is greater than 0%, then the same rule applies: At least one synchronization must be programmed.

Manual button [once]/[twice]

Synchronization	Moves to a mechanical limit (according to the setting "Synchronization at") when the manual button is pressed once or twice respectively
Adaptation	Moves to both mechanical limits and recalculates angle-dependent parameters when the manual button is pressed once or twice respectively

---

Note: For "New Generation" actuators (types MFT, MP), the function Manual button [twice] is not available.

---

## 4 Controller simulation

Go to the "Simulation" tab.

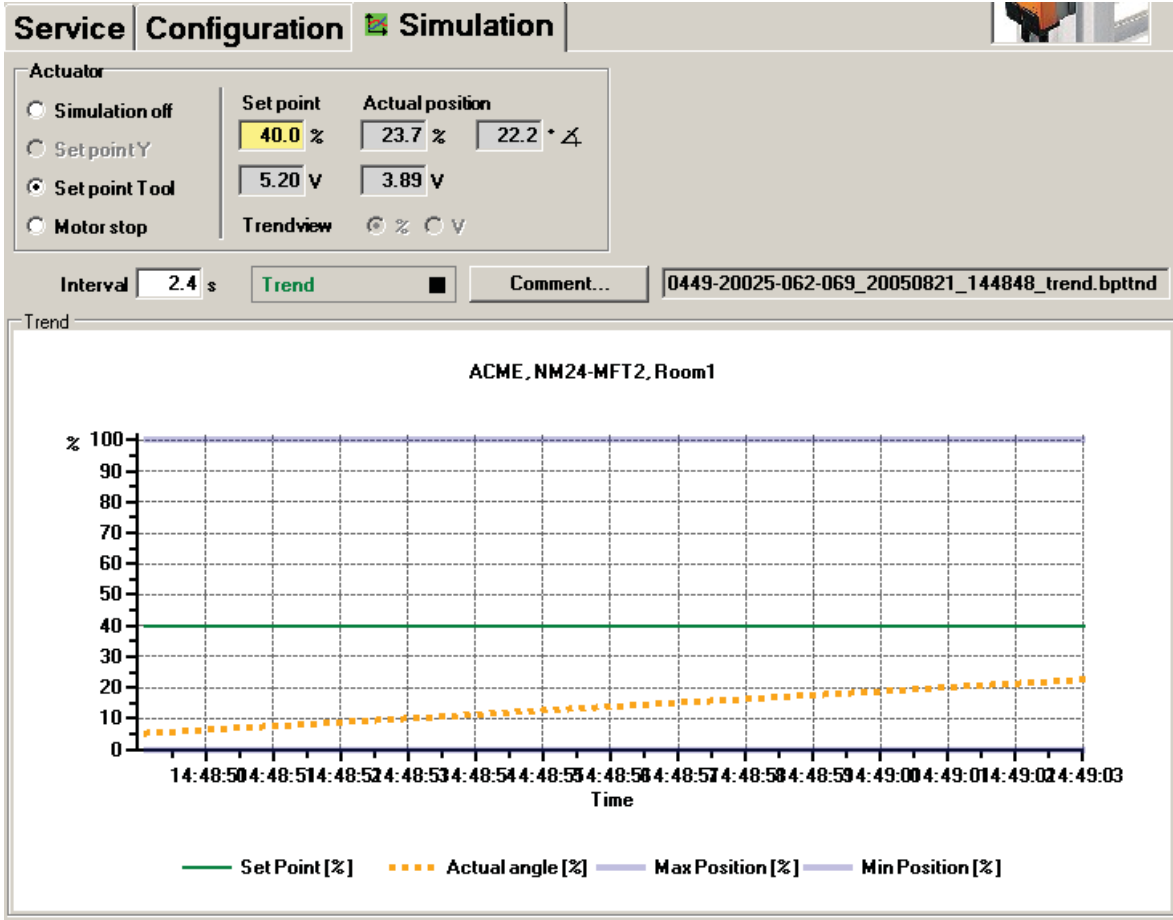

Simulation tab for damper actuators

The controller simulation is not possible while the actuator is performing an adaptation or synchronization.



## 4.1 Actuator control

Select the type of setpoint definition with the radio buttons.

- Setpoint Y (only available in PP mode): Control signal at connection Y according to selected control type (DC, PWM, open/close, 3-point).

Setpoint Tool (not available with control type open/close or 3-point): The setpoint is entered in % of the programmed range. 0% is the minimum, 100% the maximum. The input values are converted and displayed in the units of the corresponding control signal (volts, milliamps or seconds).

The control is switched off when you click "Motor stop". This function is not available with the control types open/close and 3-point.

### Measurement values

During the simulation, the current angle of rotation or stroke is displayed in % of the absolute (mechanically limited) range and – converted according to the scale setting – as a feedback value in volts or milliamps.

## 4.2 Reading out sensors and switches

The values of sensors and switches can be read out in MP mode. This function, however, must be activated in advance in the PC-Tool options under "General". Select Tools ► Options in the main menu.

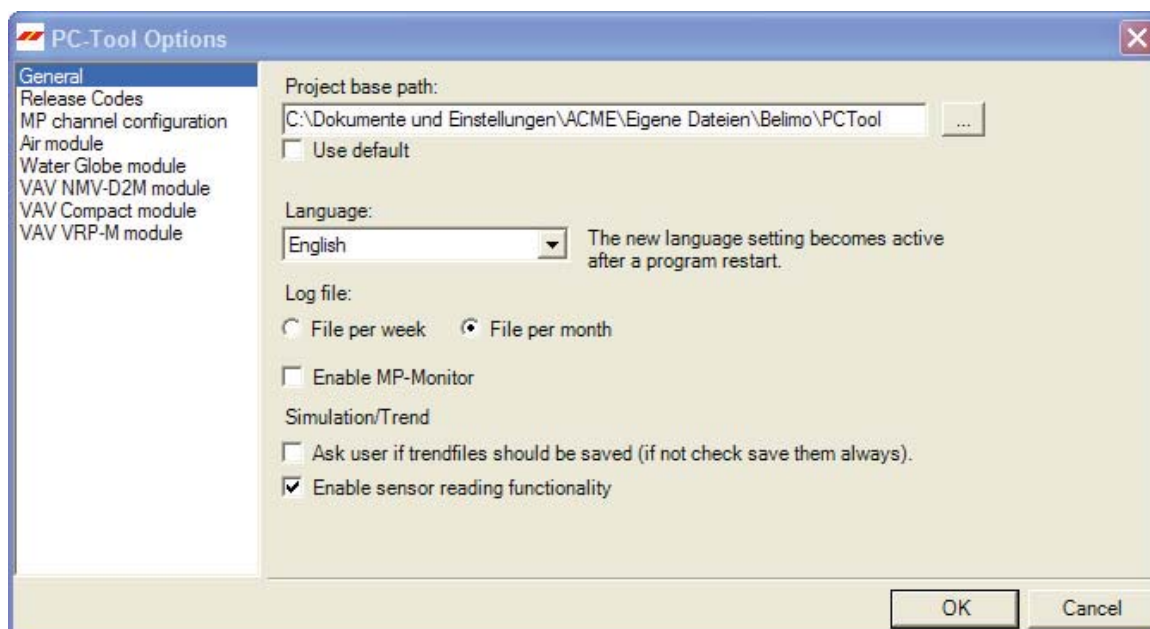

*Settings for reading out sensors*

On the Service tab, a section with the sensor values is displayed to the right of the actuator control.

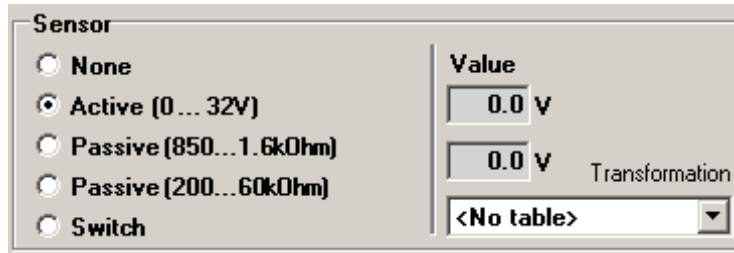

*Sensor display in MP mode*

Select the type of the connected sensor with the radio buttons. The value is either displayed in volts (active), ohms (passive) or as on/off (switch).

The transformation table allows you to additionally convert the raw value of the sensor into the corresponding measuring quantity (temperature etc.). (See the "Transformation table" section in the General User Manual)

### 4.3 Trend recording

During simulation, the time progress of the setpoints and actual values can be displayed in a plot. The values are saved in a trend file and can be displayed again at a later time. Furthermore, you can add any comment texts you would like.

In the PC-Tool options "General", you determine whether the trend file is automatically saved when the recording is finished (checkbox not selected) or whether the program should ask you. The suggested file name can be modified before saving the file.

Click the "Trend Record" button during simulation. The display changes to a "flat" button. The recording stops when you click again.

The Trend View radio buttons allow you to set whether the display is given in percent of the full range (%) or in volts (V).

The position is queried every second by default. You can change the query interval in an input box. The permitted values are 0 to 9999 seconds, whereby the value 0 means "no waiting time" (query as quickly as possible).

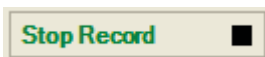
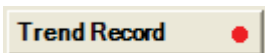

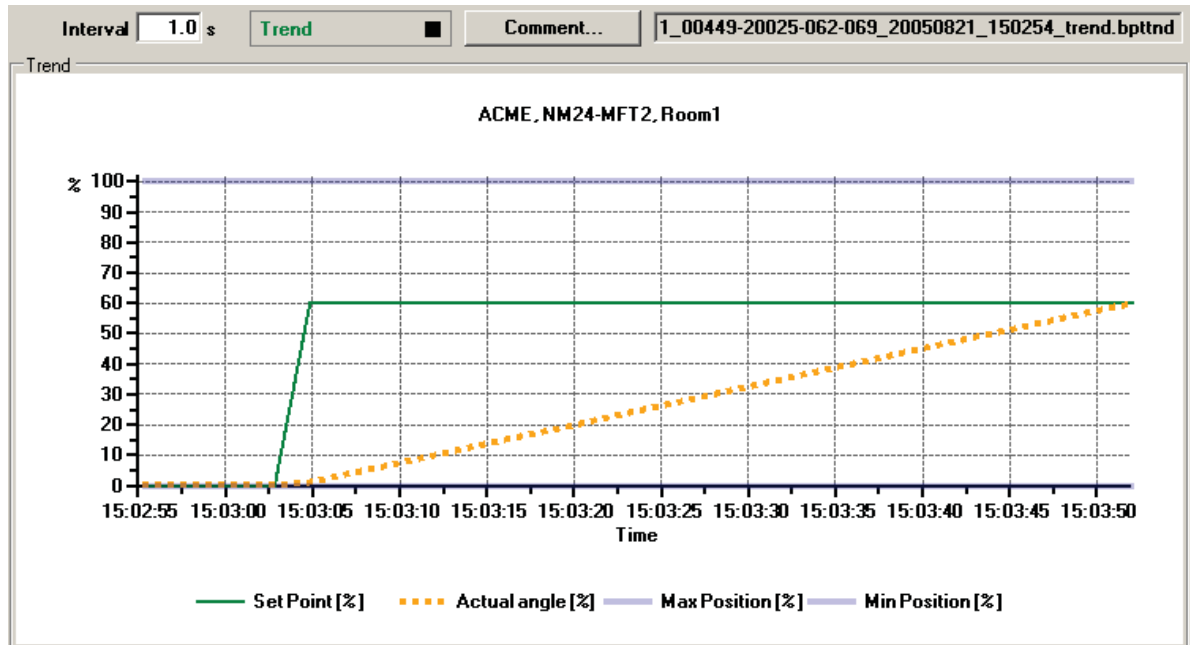

*Trend plot*

The Comment button allows you to enter a text at a defined time and the text is then saved in the trend file.

---

If you want to record a trend for more than one hour (long-term trend), enter a value of at least 2 seconds for the interval. If the interval is shorter, too many data points will result and the time for correcting the curve between the queries can become too short.

---

## 5 PC-Tool options

Select Tools ► Options in the main menu.

Option Click the right mouse button on the program icon in the outline bar and select "Options".

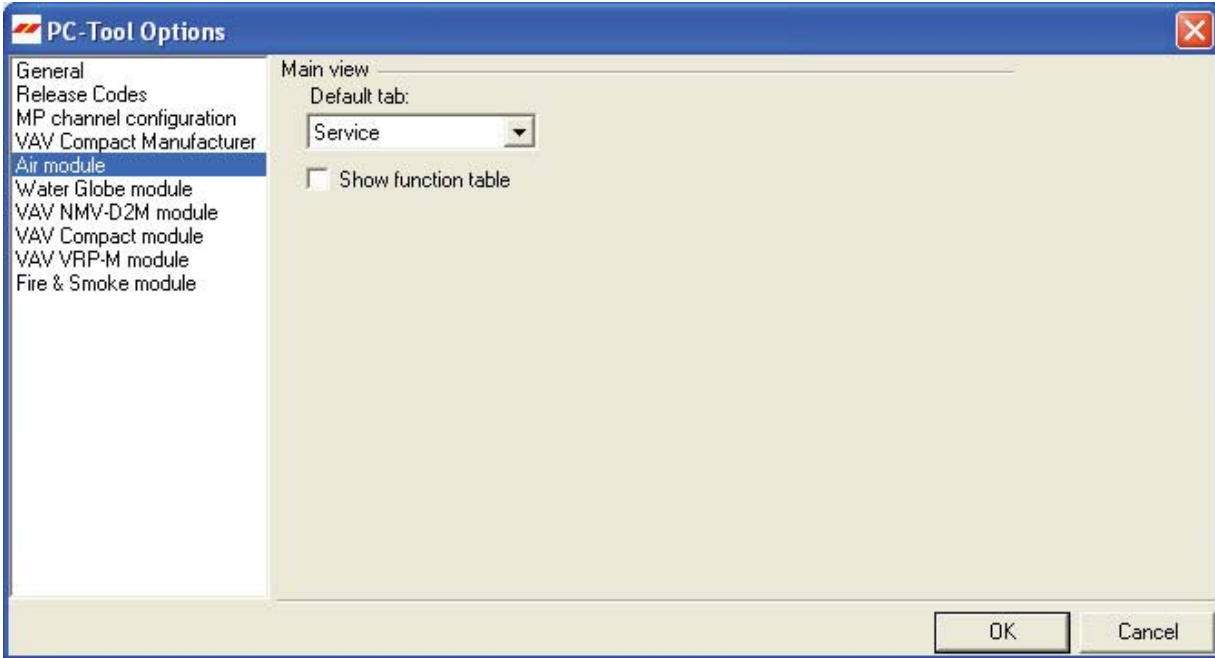

*Dialog for basic settings (Air module)*

Select "Air module" on the left.

Using the combobox "Default tab", you can select the index tab you want to open by default when starting the program PC-Tool.

If you would like to show the function table in the Configuration register, activate the "Show function table" checkbox.

# NV/NVF Series Actuators User Manual

M40035 - 05/10 - Subject to change. © Belimo Aircontrols (USA), Inc.

This page intentionally left blank.

## Table of Contents

<b>1</b>	<b>Introduction</b> .....	<b>3-3</b>
<b>2</b>	<b>Service</b> .....	<b>3-4</b>
2.1	Displaying settings .....	3-4
2.2	Adaptation .....	3-5
<b>3</b>	<b>Configuration</b> .....	<b>3-7</b>
<b>4</b>	<b>Controller simulation</b> .....	<b>3-11</b>
4.1	Actuator control .....	3-11
4.2	Reading out sensors and switches .....	3-12
4.3	Trend recording .....	3-13
<b>5</b>	<b>PC-Tool options</b> .....	<b>3-15</b>





# 1 Introduction

---

The "Water module" user manual describes the detail area [D] of the Water module for globe valve actuators. The documentation is divided according to the three tabs "Service", "Configuration" and "Simulation".

## 2 Service

### 2.1 Displaying settings

The Service tab gives an overview of the current settings of the actuator.

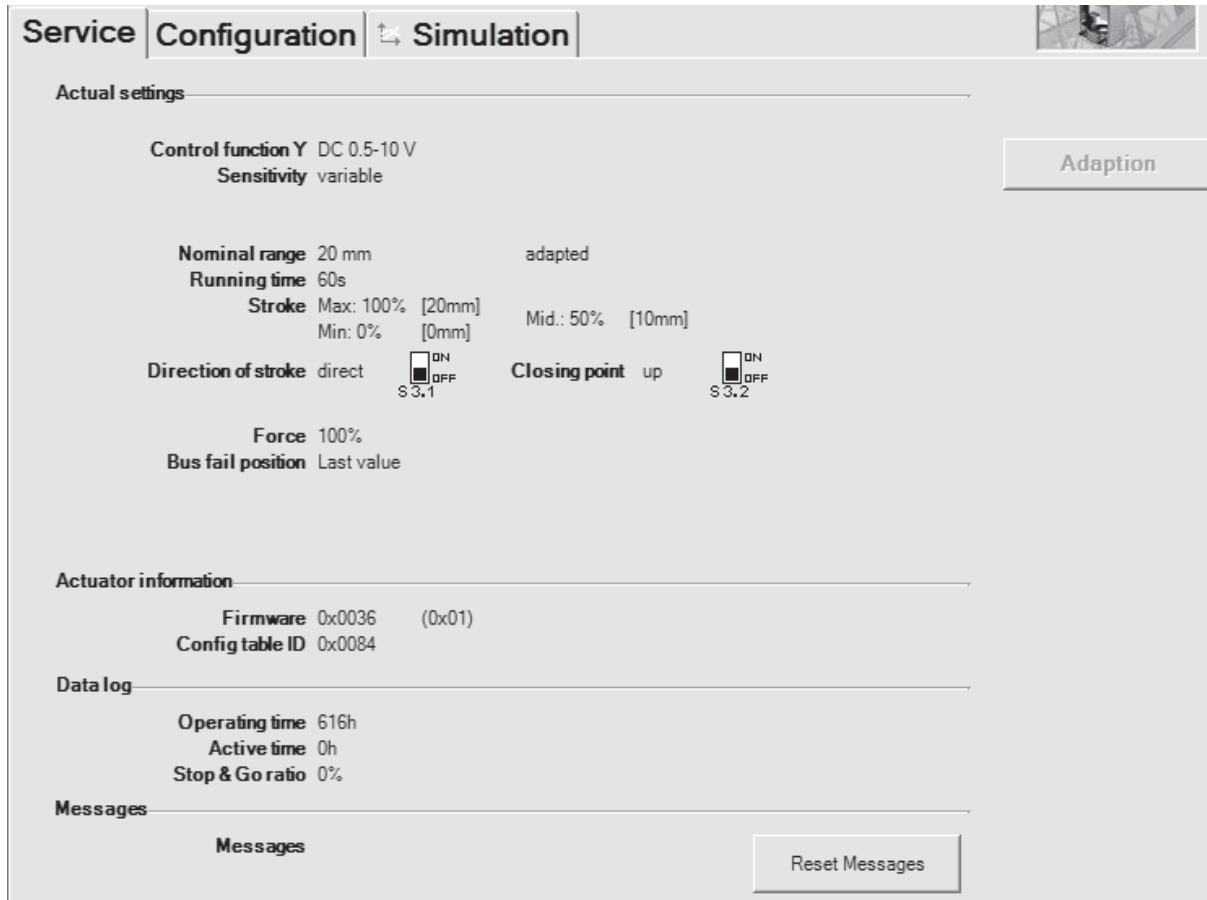

*Service tab for NV/NVF valve actuators*

### Meaning of the settings

Control signal Y	Type of control
Sensitivity	Response sensitivity and reversal hysteresis of the control function
Feedback U5	Type of feedback signal
Range	Position range within the mechanical limits
Running time	Time needed to pass through the position range
Stroke	Programmed stroke range: Max / Mid / Min
Direction of rotation	Clockwise/counterclockwise (for full-rotation actuators)
Direction of stroke	Plot of stroke direction to the positioning signal: Direct / inverted (in acc. with switch S3.1)
Switching point	Top / bottom (in acc. with switch S3.2)
Actuating force	In percent of the maximum positioning force
Behavior in the event of bus failure	Behavior when communication fails
Firmware	Software version on the actuator
Config table ID	Identification of the configuration table
Operating time	Number of hours during which the actuator was connected to the power supply
Active time	Number of hours during which the actuator was mechanically in motion and connected to the power supply
Stop & Go ratio	Ratio of active time/operating time in percent. A high Stop & Go ratio indicates an unstable control.

---

Running time, range, direction of rotation and stroke are not displayed on certain actuators.

---

## 2.2 Adaptation

In the adaptation, the actuator determines the range 0% ... 100% by approaching the mechanical limits.

Click the "Adaptation" button on the Service tab.

**Variant** You can also trigger the adaptation directly on the actuator. To do this, you have to remove the cover from the actuator. To trigger the adaptation, press the S2 button on the electronic PCB.

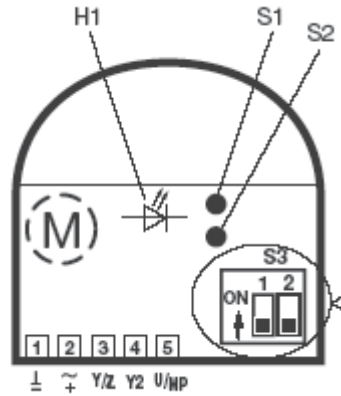

*Control element diagram with open linear actuator*

The progress of the adaptation is displayed in the status line. The actuator first moves against the programmed direction to the zero stop and then to the end stop at full stroke.

Next, the absolute values for a programmatically limited angle of rotation range (minimum, mid-position, and maximum) as well as the feedback signal U5 are recalculated and displayed.

### 3 Configuration

On the "Configuration" tab, you can read out parameter values from the actuator, change them and save them back to the actuator. The valid ranges for the parameter values are displayed in parentheses next to the input boxes.

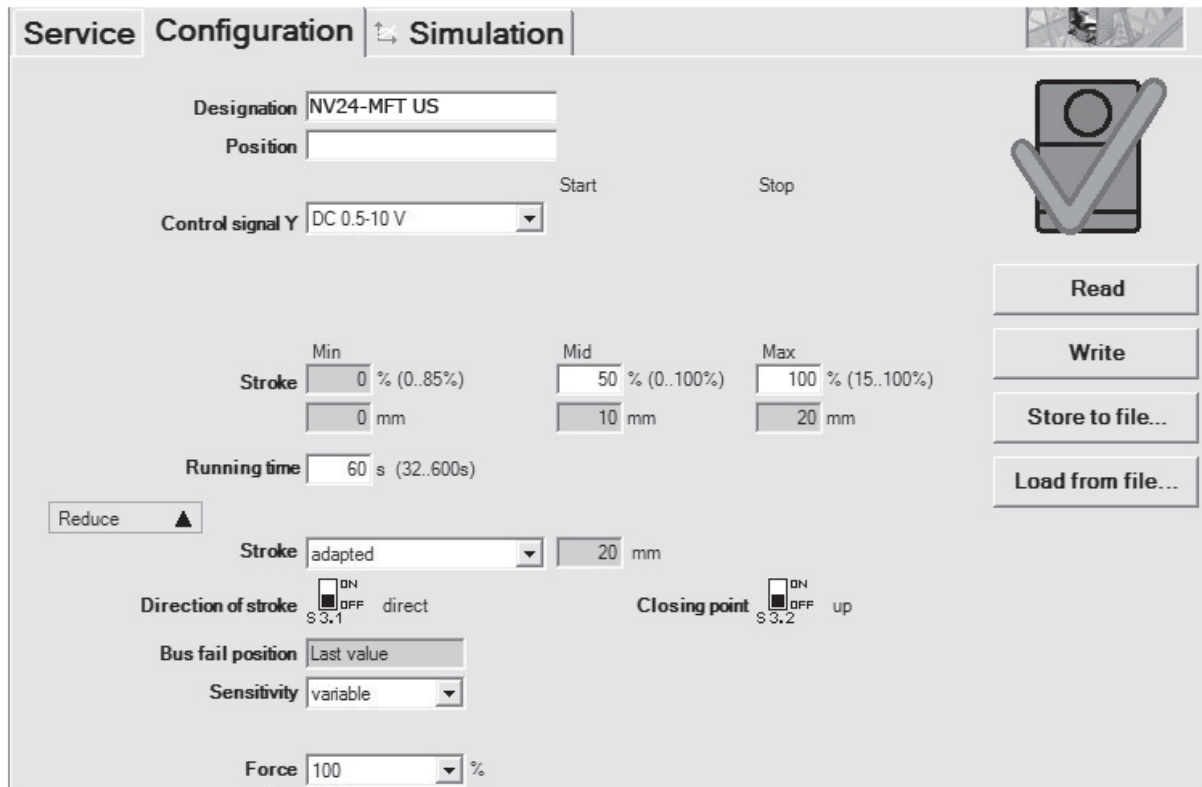

"Configuration" tab for globe valve actuators

Actuator number<sup>1</sup>

Designation	16 characters of any text
Position	16 characters of any text

<sup>1</sup> Only characters from the Western European character set are permitted for Description and Position (see General part, table in Section 4.3.3).

Control signal Y

3-point	AC voltage, positions: Open / neutral / closed
Open / closed	DC or AC voltage, 2-point
DC 0.5–10 V	(DC voltage) fixed operating range DC 0.5–10 V
DC 2–10 V modulating	(DC voltage) fixed operating range DC 2–10 V
DC variable	Start (Y=0%) 0.5 ... 30 Volt Stop (Y=100%) 2.5 ... 32 Volt Range between start and stop at least 2 V
PWM 0.02–5 s	Duration of the control impulse (pulse width modulation), fixed operating range
PWM 0.1–25.5 s	Duration of the control pulse, fixed operating range
PWM 0.59–2.93 s	Duration of the control pulse, fixed operating range
PWM variable	Start (Y=0%) minimum 0.02 seconds Stop (Y=100%) maximum 50 seconds

Feedback U5 (only active when the actuator address is set to PP)

Valve setting 2 -10V	DC voltage measurement signal, fixed range
Valve setting 0.5 -10V	DC voltage measurement signal, fixed range
Variable valve setting	DC voltage measuring signal Start 0.5...8.0 Volt / Stop 2.5 ... 10.0 V Range between start and stop at least 2 V

Scaling U5 (with "New Generation" actuator only)

Start	Position in percent, corresponds to the start value of the feedback signal
Stop	Position in percent which corresponds to the stop value of the feedback signal

Stroke

Min	Programmed lower limit of the range (cannot be changed)
Mid	Mid-position of range
Max	Programmed upper limit of the range

An existing value for Mid is automatically adapted when Max is entered: Mid is always less than or equal to this input value.

Examples of settings for control signal Y / feedback U5

**Control signal Y:** 3...8 V min: 30%, max : 70%  
**Feedback U5 :** 2...7 V start: 20%, stop: 90%

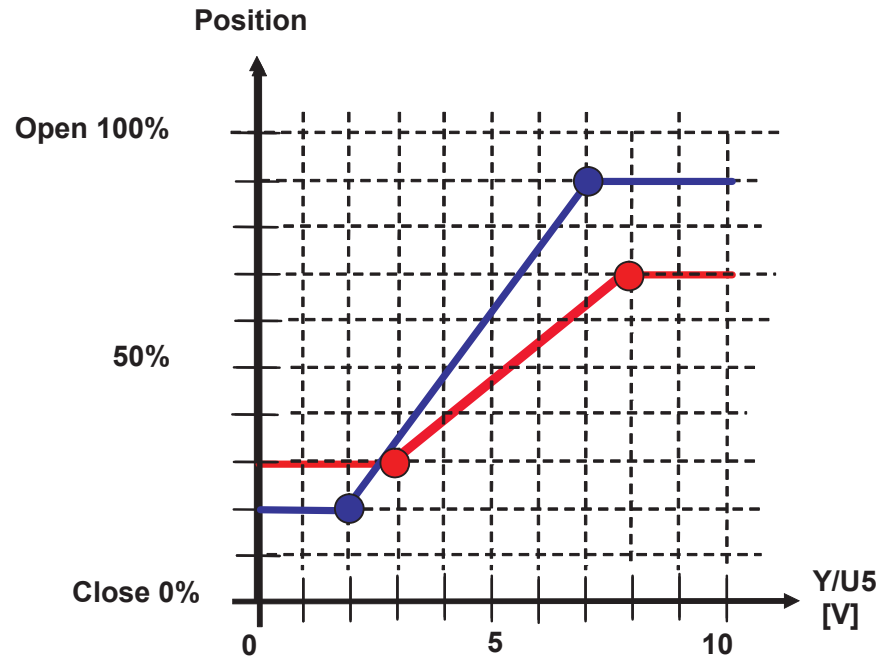

Running time

In seconds	Time needed to pass through the range limited by Min and Max (the valid range of values for the running time depends on the actuator type and the passed-through range)
------------	---

Stroke

Adapted	from the mechanical limits of certain stroke
Programmed	The valid values depend on the maximum nominal positioning range of the actuator

Stroke direction (in acc. with switch S3.1)

Direct	0% positioning signal is equivalent to 0% position feedback.
inverted	0% positioning signal is equivalent to 100% position feedback.

Closing point (in acc. with switch S3.2)

top	The linear spindle is moved into the actuator with the valve closed and the stem is moved out of the fitting.
bottom	The linear spindle is moved out of the actuator with the valve closed and the stem is moved into the fitting.

Behavior in the event of bus failure (currently cannot be changed)

Last setpoint	Position according to control signal Y
---------------	--

Sensitivity

Normal	
– Response sensitivity:	1% @ Operating range
– Reversal hysteresis	2.5% @ Operating range
Damped	
– Response sensitivity:	2% @ Operating range
– Reversal hysteresis	5% @ Operating range

Actuating force

25% ... 100%	Can be set in increments of 25%. 100% corresponds to the maximum positioning force for the actuator type (see nameplate)
--------------	--



## 4 Controller simulation

Go to the "Simulation" tab.

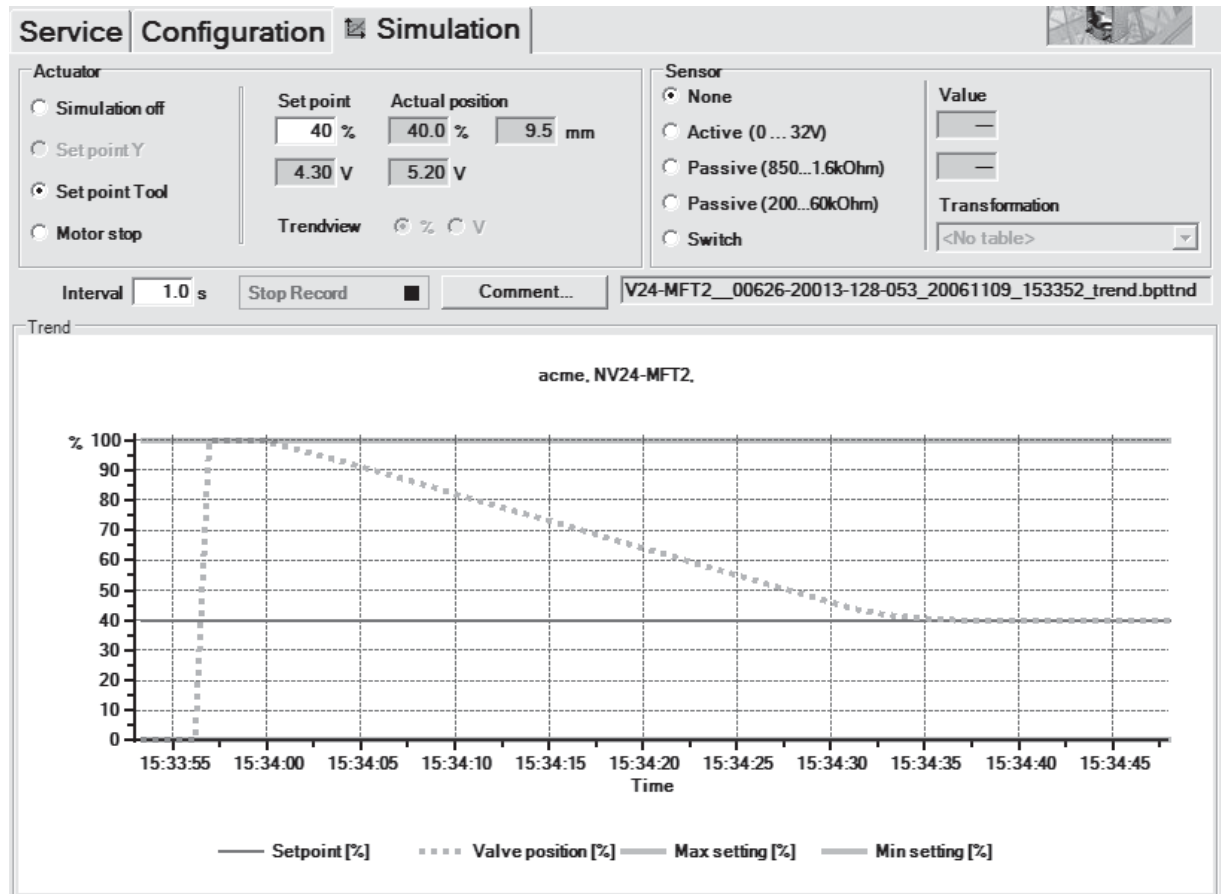

"Simulation" tab for globe valve actuators

The controller simulation is not possible while the actuator is performing an adaptation or synchronization.

### 4.1 Actuator control

Select the type of setpoint definition with the radio buttons.

- Setpoint Y (only available in PP mode): Control signal at connection Y according to selected control type (DC, PWM, open/close, 3-point).
- Setpoint Tool (not available with control type open/close or 3-point): The setpoint is entered in % of the programmed range. 0% is the minimum, 100% the maximum. The input values are converted and displayed in the units of the corresponding control signal (volts or seconds).

The control is switched off when you click Motor stop. This function is not available with the control types open/close and 3-point.

#### Measurement values

During the simulation, the stroke is displayed in % of the absolute (mechanically limited) range in millimeters and – converted according to the scale setting – as a feedback voltage in volts.

## 4.2 Reading out sensors and switches

The values of sensors and switches can be read out in MP mode. This function, however, must be activated in advance in the PC-Tool options under "General". Select Tools►PC-Tool options... in the main menu.

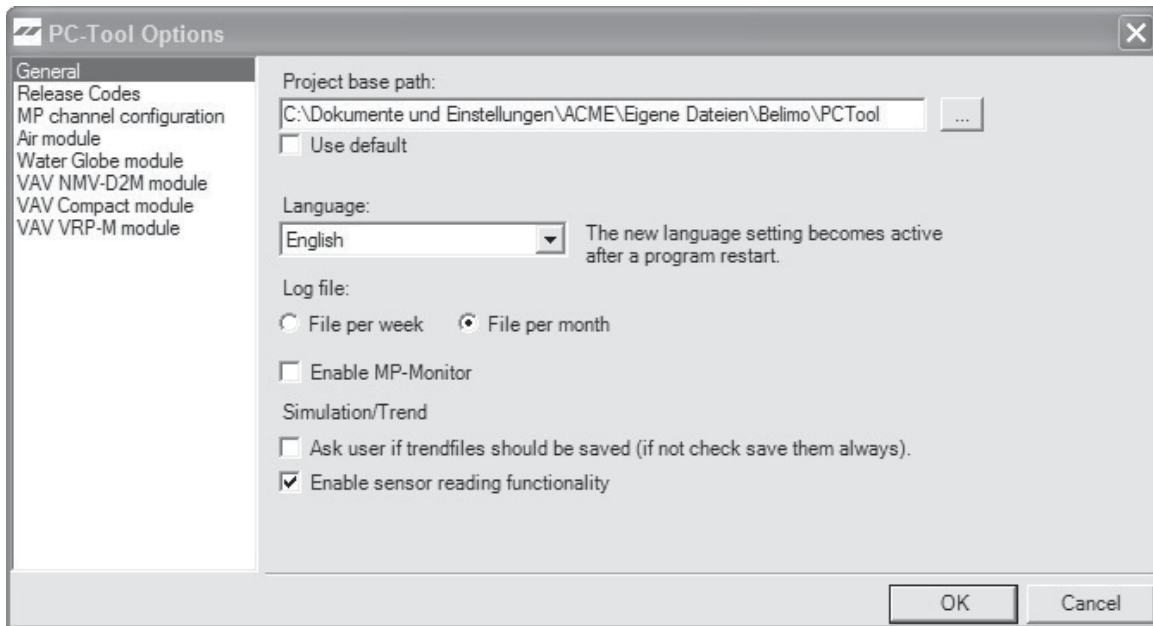

*Settings for reading out sensors*

On the Service tab, a section with the sensor values is displayed to the right of the actuator control.

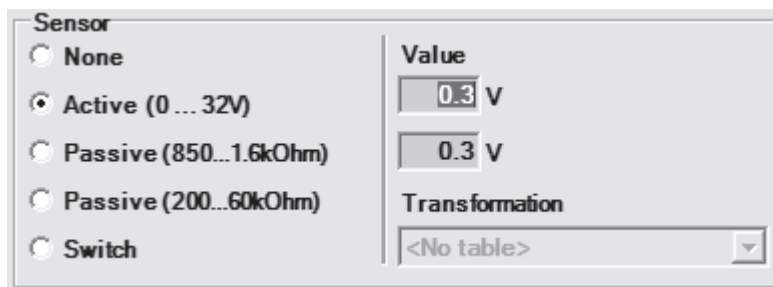

*Sensor display in MP mode*

Select the type of the connected sensor with the radio buttons. The value is either displayed in volts (active), ohms (passive) or as on/off (switch).

The transformation table allows you to additionally convert the raw value of the sensor into the corresponding measuring quantity (temperature etc...). (See the "Transformation table" section in the General User Manual)

### 4.3 Trend recording

During simulation, the time progress of the setpoints and actual values can be displayed in a plot. The values are saved in a trend file and can be displayed again at a later time. Furthermore, you can add any comment texts you would like.

In the PC-Tool options "General", you determine whether the trend file is automatically saved when the recording is finished (checkbox not selected) or whether the program should ask you. The suggested file name can be modified before saving the file.



Click the "Trend Record" button during simulation. The display changes to a "flat" button. The recording stops when you click again.

The Trend View radio buttons allow you to set whether the display is given in percent of the full rotation range (%) or in volts (V).

The position is queried every second by default. You can change the query interval in an input box. The permitted values are 0 to 9999 seconds, whereby the value 0 means "no waiting time" (query as quickly as possible).

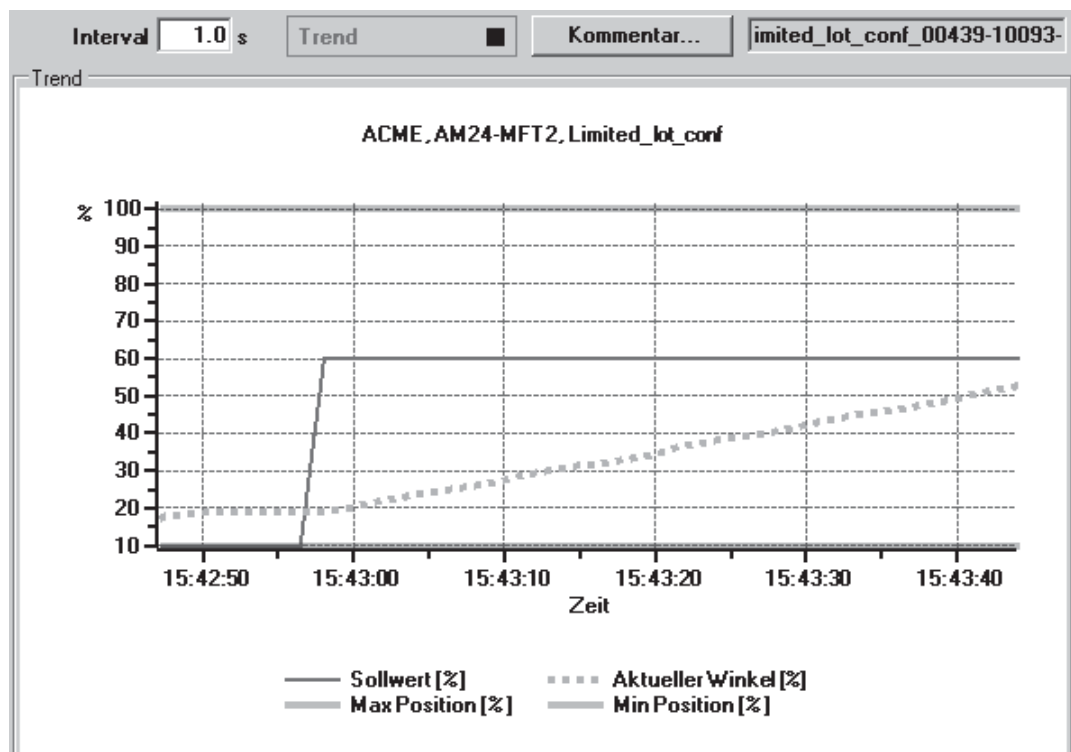

Trend plot

The Comment button allows you to enter a text at a defined time and the text is then saved in the trend file.

---

If you want to record a trend for more than one hour (long-term trend), enter a value of at least 2 seconds for the interval. If the interval is shorter, too many data points will result and the time for correcting the curve between the queries can become too short.

---

## 5 PC-Tool options

Select Tools▶PC-Tool options... in the main menu.

Variant Click the project in the outline bar [C] with the right mouse button and select PC-Tool options.

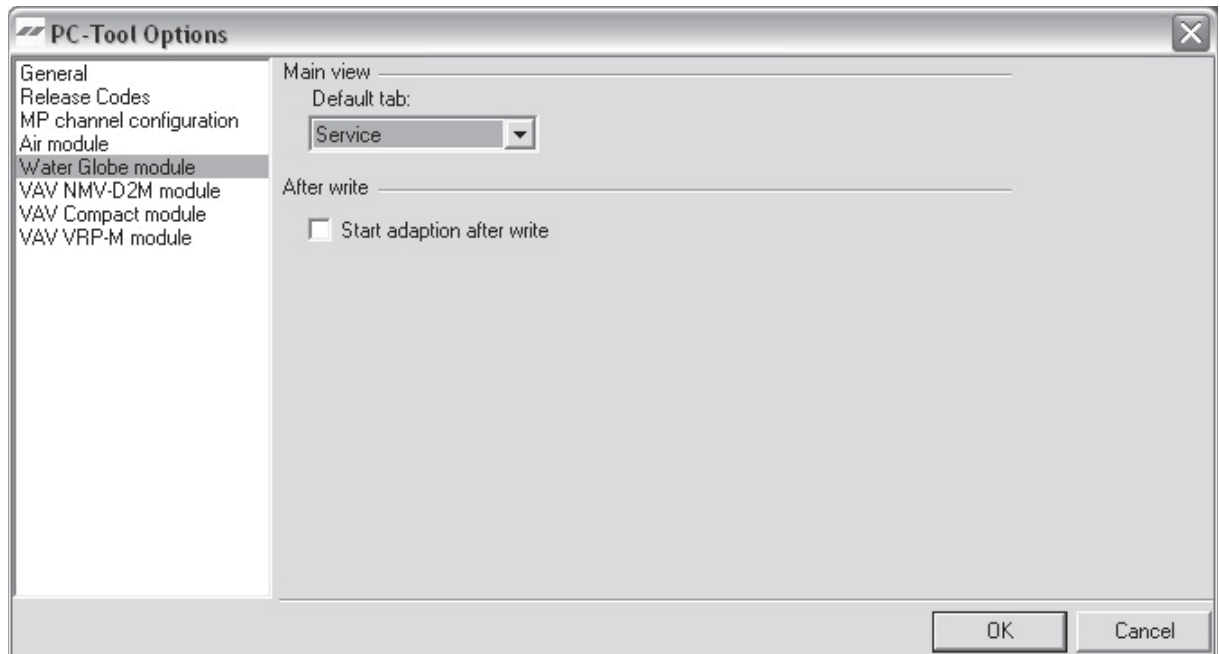

*Dialog for basic settings (Water module)*

Select "Water/globe module" on the left.

Using the combobox "Default tab", you can select the index tab you want to open by default when starting the program PC-Tool.

If an adaptation is to be performed after every programming operation, select "Start adaption after write".



# PC-Tool V3.5 ePIV Module

## Electronic Pressure Independent Valve

### User Manual

#### English

M40035 - 05/10 - Subject to change. © Belimo Aircontrols (USA), Inc.





# Table of Contents

1	Introduction.....	4-3
2	Service.....	4-4
2.1	Show Settings .....	4-4
2.2	Adaption .....	4-6
2.3	Synchronisation.....	4-6
2.4	Function Test .....	4-7
3	Configuration .....	4-9
3.1	Settings .....	4-10
4	Controller Simulation .....	4-12
4.1	Actuator Control (Actuator) .....	4-13
4.2	Test .....	4-13
4.2.1	Test scripts .....	4-13
4.4	Recording Trends.....	4-15
5	PC-Tool Options for ePIV Module .....	4-16



# 1 Introduction

The ePIV Module User Manual describes the detail area [D] of the module for the ePIV controller (Electronic Pressure Independent Valve, pressure-independent flow controller). The documentation is divided up in accordance with the tabs for "Service", "Configuration" and "Simulation".

---

**Note**

For function and wiring, see Product Information.

---

## 2 Service

### 2.1 Show Settings

The Service tab offers an overview of the current settings of the EPIV controller.

*Service tab for EPIV controller*

In the general section of this user manual, a description is given as to how you can print out the control parameters [chapter 3.6.2.] or delete the maintenance and error messages [chapter 3.6.3].

### Meaning of the settings

Control function	Flow control or open loop operation
Control function Y	Type of control. If the control function is interpreted as inverted, then this will be displayed.
Characteristic curve	The EPIV controller works with either an equal-percentage or a linear characteristic curve. Characteristic curve off means "linear", characteristic curve on means "equal percentage". The two characteristic curves (feedback U5 and control function Y) are always either simultaneously activated or simultaneously deactivated.
Feedback U5	Type of feedback signal (conventional operation)
Nominal range	Nominal position range within the mechanical limits
Valve size	Size of the valve; is set by Belimo. If the specified volumetric flow scale with respect to the valve size has been changed from the factory setting, then the label marked "Scaling adjusted" will appear.
Volumetric flow settings	Operating volumetric flow settings: V'nom / V'max (only V'nom in open loop operation)
Synchronisation at	Stop position 0% or 100%
Bus fail position	Position in the event of MP communications failure
Power ON	Behaviour/Function when switching on the device or after a voltage interruption, respectively
Gear release button	Function when the gear release button is pressed
Firmware	Software version of the EPIV controller
Config table ID	Identification of the configuration table of the EPIV
Operating time	Number of hours during which the actuator was connected to the supply
Active time	Number of hours during which the actuator was mechanically moving and connected to the supply
Stop & Go ratio	Ratio of active time/operating time in percent. A high Stop & Go ratio (red) indicates that the control is unstable.

The following additional settings appear when EPIV is combined with Super Cap:

Power Fail-/Power off Pos.	Actuator position after failure of the supply voltage
Power fail Delay	Time after the failure of the supply voltage and before the actuator begins to move to the emergency setting position.
Power fail Count	Number of voltage interruptions

Converting units for volumetric flow

Select Tools ▶ PC-Tool Options in the main menu.

Click on "EPIV Module" at the left.

You can determine the physical units for the volumetric flow with the Combobox volume display

- l/min (litres per minute)
- m<sup>3</sup>/h (cubic metres per hour)
- l/s (litres per second)
- l/h (litres per hour)
- gpm (gallons per minute)

This setting applies for all displays, printouts, labels and writing into the log file [see general section of this user manual].

## 2.2 Adaption

With adaption, the actuator determines the available range 0% ... 100% by approaching the mechanical limits.

To start, click the "Adaption" button in the Service tab.

The progress of the adaption is displayed in the status bar. The actuator first moves against the programmed direction to the zero end stop and then to the end stop with complete valve opening.

The actuators can be configured in such a way that an adaption will be triggered automatically when the supply voltage is switched on.

## 2.3 Synchronisation

During synchronisation, one mechanical limit is approached in order to compare the position calculation.

Each actuator can be programmed to determine whether synchronisation is to be carried out at the zero end stop (0%) or with full valve opening (100%).

To start, click the "Synchronisation" button in the Service tab.

Variant You can also trigger the synchronisation directly at the actuator by pressing the gear release button.

The progress of the synchronisation is displayed in the status bar. If synchronisation at: is set to Y=0%, the actuator will move against the programmed direction to the zero end stop; if on the other hand synchronisation at: is set to Y=100%, then it will move to the end stop with full valve opening.

The actuators can be configured in such a way that a synchronisation will be triggered automatically when the plant is switched on.

## 2.4 Function Test

The opening and closing of the valve is checked during the function test.

The actuator first moves in accordance with the synchronisation position to the mechanical end stop. If the range is set to "adapted", then the other end stop will be approached; if it is set to "programmed", on the other hand, then it will move to the programmed range limit.

Click on the "Test" button in the Service tab. The normal display will then be covered over by the test window.

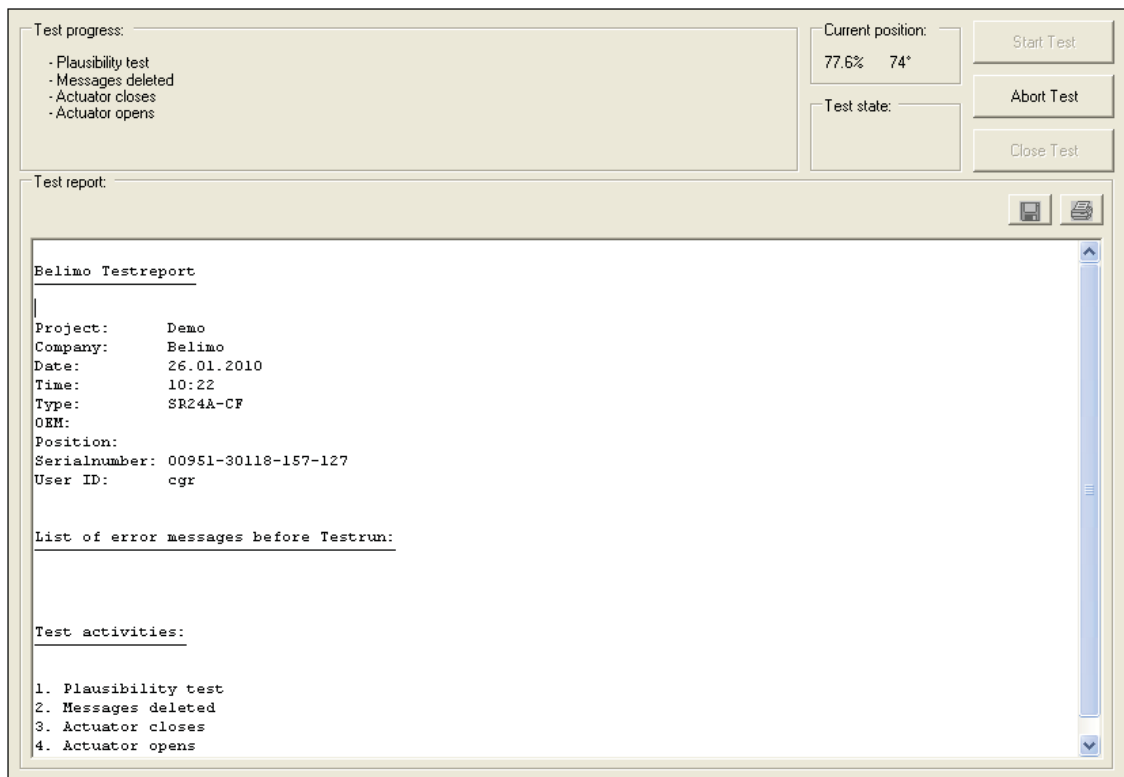

### *Display of test progress and test report*

Click on the "Start Test" button.

The progress and the current position will be displayed continuously.

The test report contains

- information concerning the project,
- the identification of the EPIV controller,
- a list of the error messages in effect before the start of the test,
- the test steps and the test result,
- the current controller settings.

---

If the test reports an invalid controller configuration, switch over to the "Configuration" tab after the test has been completed. There you will find the non-permitted values marked with a flashing exclamation mark.

---

You can save the test report as a file by clicking on the floppy disk symbol or print it out by pressing on the printer symbol.

End the function test by pressing on the "Close Test" button. The program will ask whether you would now like to save a test report that has not yet been saved.

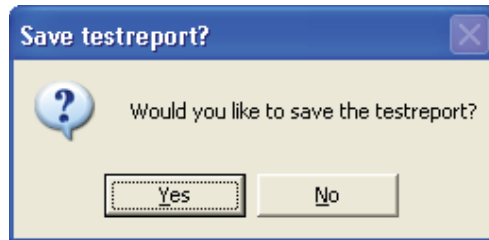

If you abort the test prematurely, then no test report will be compiled.



### 3 Configuration

In the "Configuration" tab, you can read out the parameter values from the EPIV controller, modify them and save them as a text file.

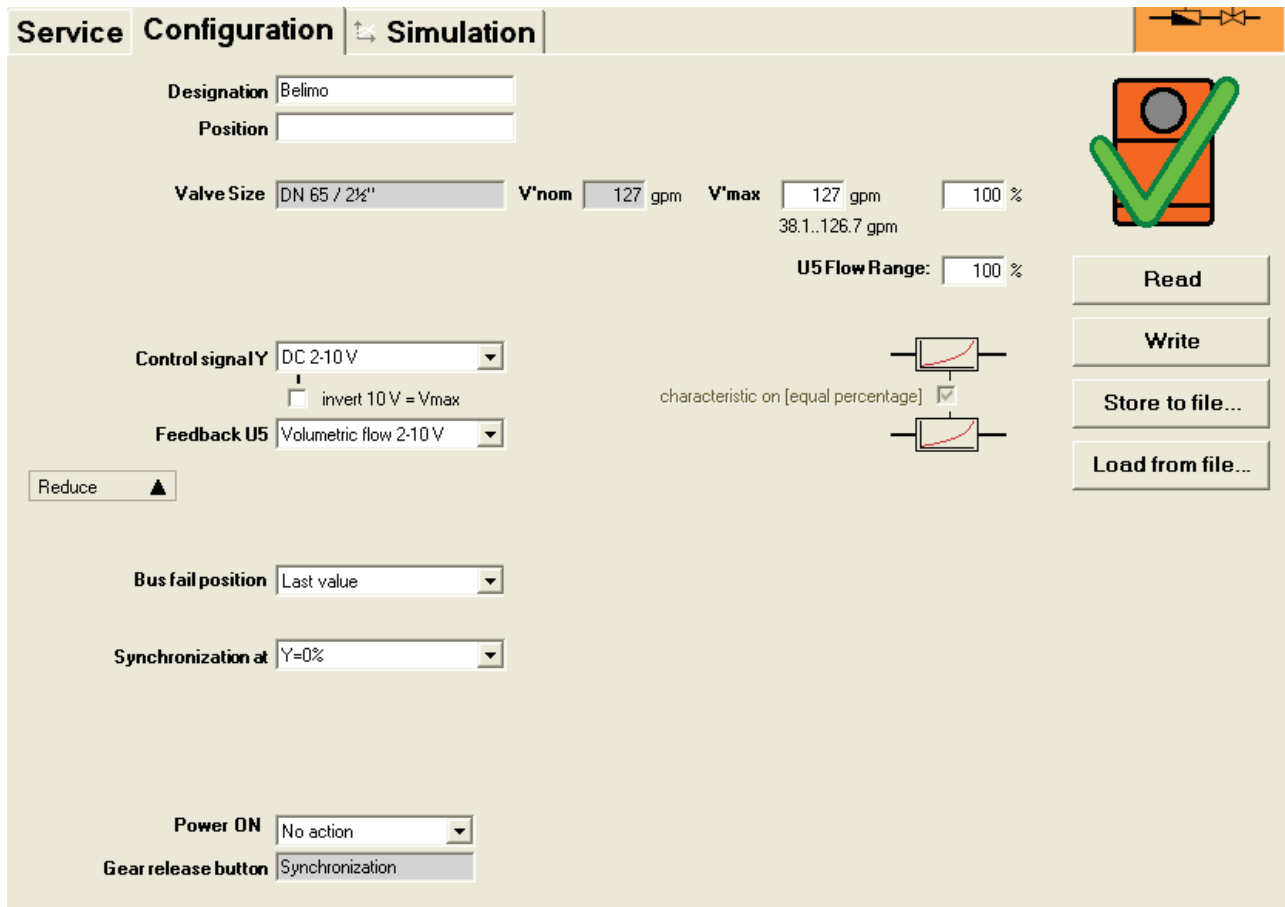

"Configuration" tab for EPIV controller

The extended configuration in the lower area will become visible when you click on "Expand".

## 3.1 Settings

### Controller ID<sup>1</sup>

Designation	16 characters of any text
Position	16 characters of any text

### Valve size

Selection list with valve sizes	Sets the valve size and thus also the nominal volumetric flow specified by the manufacturer (default nominal volumetric flow, if a release code is available, can be modified. See below: "Display scaling").
---------------------------------	---

### Volumetric flow, nominal

V'nom	Nominal volumetric flow (is set by the manufacturer)
-------	--

### Volumetric flow range

V'max	Upper limit of the operating volumetric flow setting (in selected unit or in %)  The possible range is displayed under the box, it lies between 30% - 100% of V'nom.
U5 volumetric flow range	Upper limit for the U5 volumetric flow range. This value is typically the same as V'max[%].  The value only has an influence on the U5 feedback voltage value.

You can change the physical units for the volumetric flow in "Tools ▶ PC-Tool Options" in the main menu [see chapter 2.2.].

An existing value for U5 volumetric flow range will automatically adjust itself to the V'max when the latter is entered. On the other hand, the V'max will not change if you change the U5 volumetric flow range yourself.

### Control signal Y

DC 0.5 ... 10V	Fixed operating range 0.5 ... 10V
DC 2 ... 10V	Fixed operating range 2 ... 10V
DC variable	Start (Y=0%) 0 ... 8V Stop (Y=100%) 2.0 ... 32V Range between start and stop at least 2V

### Control function Y inverted

on	Inverts the control function Y (lowest voltage = V'max)
----	---

<sup>1</sup> Only characters from the Western European character set are permitted to be used for designation and position (see general section, table chap. 4.3.3).

off	Control function Y normal (highest voltage = V'max)
-----	--

Feedback U5 (active only if actuator address is set to PP)

Volumetric flow 0.5 ... 10V	Volumetric flow feedback 0 ... 100%, V'nom = 0.5 ... 10V
Volumetric flow 2 ... 10V	Volumetric flow feedback 0 ... 100%, V'nom = 2 ... 10V
Volumetric flow variable	Volumetric flow feedback 0 ... 100%, V'nom Start 0.0 ... 8.0 volt / stop 2.0 ... 10.0V Range between start and stop at least 2V

Characteristic curve

Equal percentage	Characteristic curves for control function Y and feedback U5 switched on (input signal to volume equal percentage)
------------------	--

Bus fail position

Last setpoint	Volumetric flow in accordance with the last setpoint of the MP master received
Open	Open valve (100%, valve completely open)
Close	Close valve
Max / V'max	V'max volumetric flow

Synchronisation at

Y = 0%	Approaching the mechanical limit with zero end stop (valve closed)
Y = 100%	Approaching the mechanical limit with full valve opening

With Power ON

Adaption	Approaching both mechanical limits and recalculation of angle-dependent parameters
Synchronisation	Approaching one mechanical limit (in accordance with the setting "Synchronisation at")
No action	

Gear release button

Synchronisation	(preset for EPIV actuators)
-----------------	-----------------------------

## 4 Controller Simulation

Switch over to the "Simulation" tab.

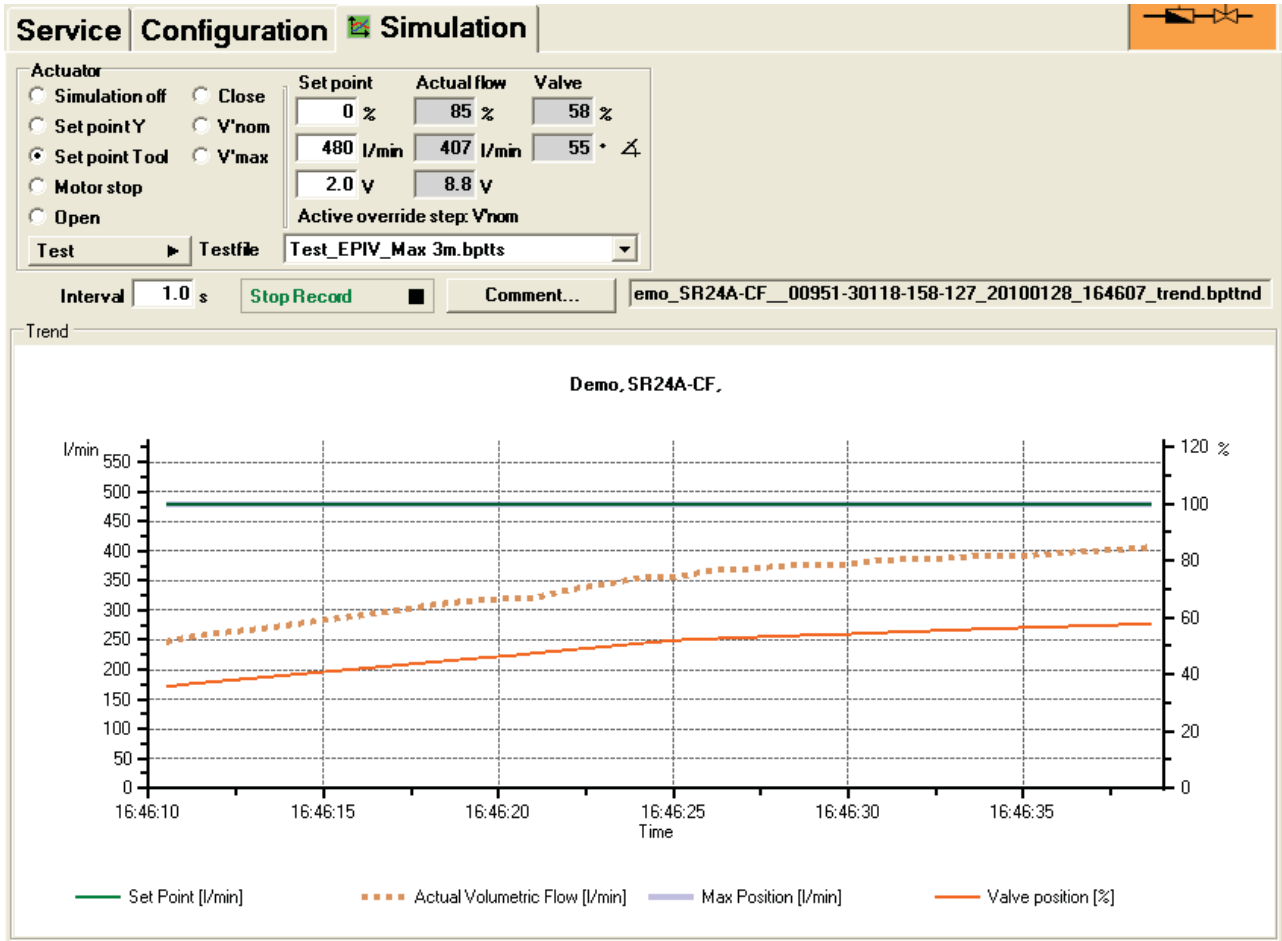

"Simulation" tab for VAV controllers

Control simulation will be influenced if the actuator is currently carrying out an adaption or a synchronisation. The "Motor Stop" function overrides any ongoing adaption or synchronisation.

## 4.1 Actuator Control (Actuator)

Use the radio buttons to select the setpoint specification.

- Setpoint Y: Control function at connection Y.
- Setpoint tool: Input of the setpoint in % of the volumetric flow (100% corresponds to V'max), as volumetric flow value (e.g. l/min) or as control function (volts).

Clicking on "Motor Stop" stops the actuator.

The following override steps can be specified per radio button.

- Open: Valve completely opened
- Close: Valve completely closed
- V'nom: Nominal volumetric flow
- V'max: Volumetric flow V'max (100%)

Measured values

The following are displayed:

- The current volumetric flow 0 ... 100% of the V'nom
- The actual flow of the volumetric flow in l/min or the selected unit
- The feedback voltage in volt (U5 signal)
- The valve opening in %
- The current angle of rotation in angular degrees
- An active override step is displayed as text, independently of whether it was specified by the PC-Tool or externally (control function Y)

## 4.2 Test

The test function is available for the structured testing of the EPIV actuator.

A number of commands which follow one another in sequence [see 4.2.1] are defined in a test script file. A trend record is triggered at the start of the function.

Select test file

Select the desired scrip with the Combobox test file. Only test scripts for EPIV modules are displayed in the Combobox.

Start test script

Click on the test ▶ button. The tests will begin at once.

Create test script

In accordance with the templates, users can also create test scripts of their own. File name must contain the character block "EPIV".

### 4.2.1 Test scripts

The following test scripts are available as templates.

Name of the test file	Functions
Test_EPIV_Max 3m.bpts	V'max – 3 minutes
Test_EPIV_Max-Auto-Min 9m.bpts	V'max – 3 minutes Auto – 3 minutes V'min – 3 minutes

IM40035 - 05/10 - Subject to change. © Belimo Aircontrols (USA), Inc.

### 4.3 Recording Trends

The progression over time of the setpoint and actual values can be displayed in a diagram during the simulation. The values are saved to a trend file and can be displayed again at a later date. In addition, commentary texts of one's choosing can be added.

In the PC-Tool Options General, you define whether the trend file is saved automatically when the recording is completed (checkbox not selected) or whether the program should inquire about your preferences.



During the simulation, click on the "Trend Record" button. The display changes to a "flat" button. Clicking once more will interrupt the recording.



According to the presettings, measured values are queried at one-second intervals. You can change the querying interval in the interval input box. The permitted values range from 0 to 9999 seconds, for which the value "0" means "no waiting time" (querying as rapidly as possible).

If you wish to record a trend for more than one hour (long-term trend), enter a value of at least 2 seconds for the interval. Shorter intervals cause too many data points to be created and the time for plotting the curve between the queries could become too short.

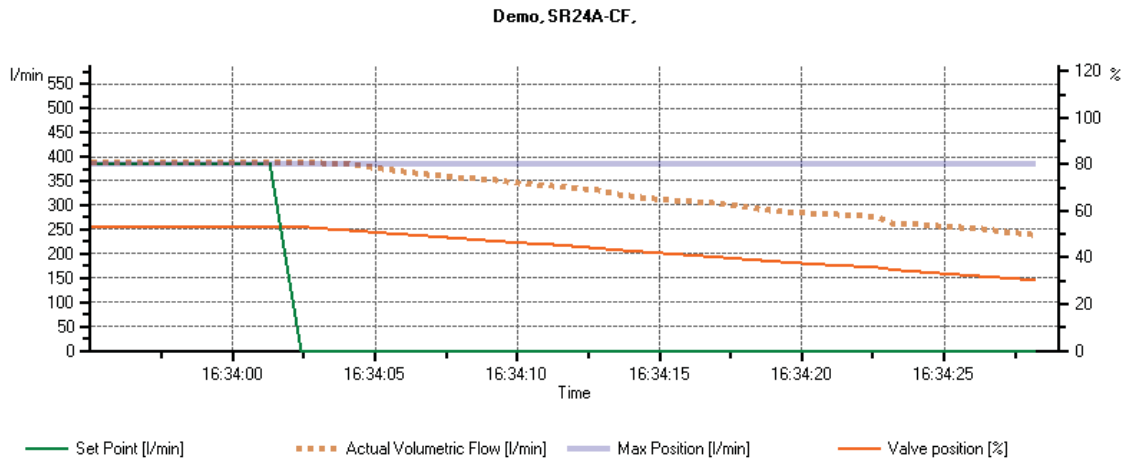

*Trend diagram*

You can use the comment button to enter a text at a defined point in time, which is then saved in the trend file.

## 5 PC-Tool Options for EPIV Module

Select Tools ► PC-Tool Options in the main menu.

Variant Right-hand mouse click on the program symbol in the overview bar and select PC-Tool Options.

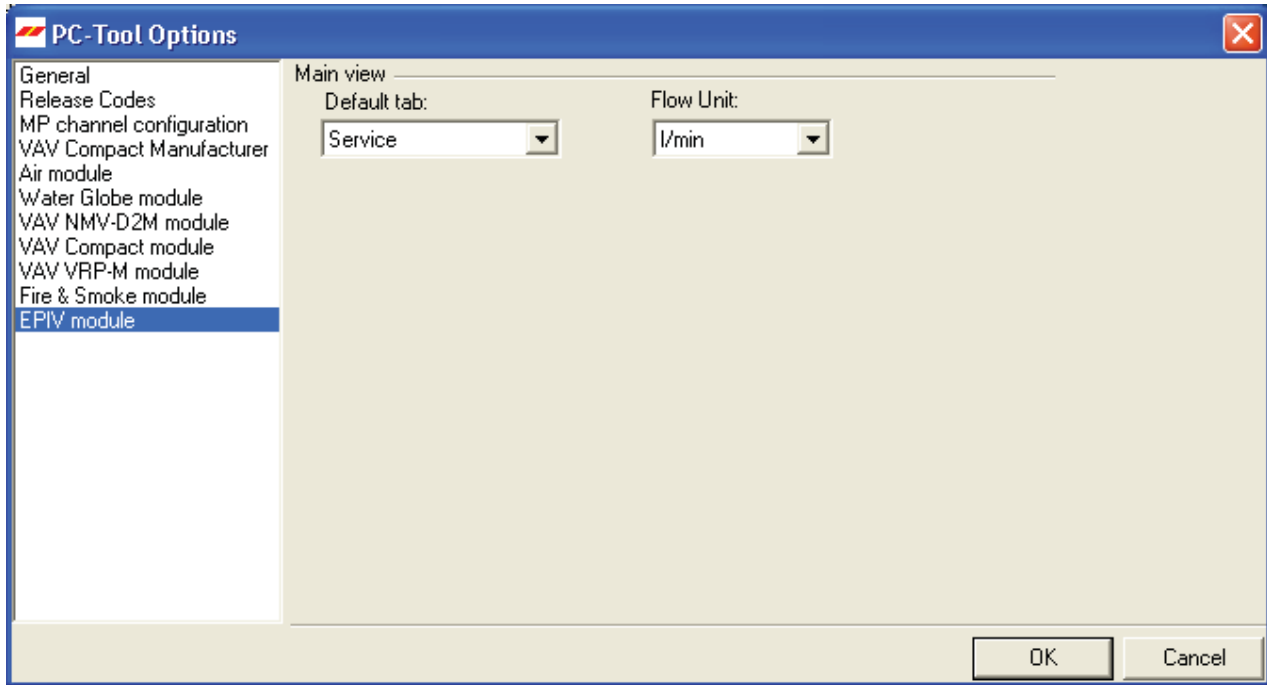

*Dialogue for basic settings (EPIV Module)*

Click on "EPIV Module" at the left.

### Main window

In accordance with the most frequent usage, use the "Default Register" Combobox to determine which tab is to be opened in the default settings when the program is started up.

You can select the physical units for the volumetric flow with the Combobox volume display

- l/min (litres per minute)
- m<sup>3</sup>/h (cubic metres per hour)
- l/s (litres per second)
- l/h (litres per hour)
- gpm (gallons per minute)



# SY-MFT Series Actuators User Manual

M40035 - 05/10 - Subject to change. © Belimo Aircontrols (USA), Inc.

# **PC-Tool User Manual**

for SY-MFT Series Actuators

## Table of Contents

1	Introduction.....	5-3
2	Service .....	5-4
2.1	Displaying settings .....	5-4
2.2	Adaptation.....	5-5
3	Configuration .....	5-7
4	Controller simulation.....	5-11
4.1	Actuator control.....	5-11
4.2	Trend recording.....	5-13
5	PC-Tool options.....	5-15



# 1 Introduction

This user manual describes the detail area for valves using SY actuators. The documentation is divided according to the three tabs "Service", "Configuration" and "Simulation".

In April 2008, Belimo launched the new SY-MFT to replace its existing proportional actuator the SYx-P. The new electronics, designed by Belimo's engineering group, was an extension of the new generation non-spring actuator platform successfully launched years prior.

The SY-MFT contains most benefits found in Belimo's tradition MFT offering except for the ability to change the running time.

## Typical wiring diagram

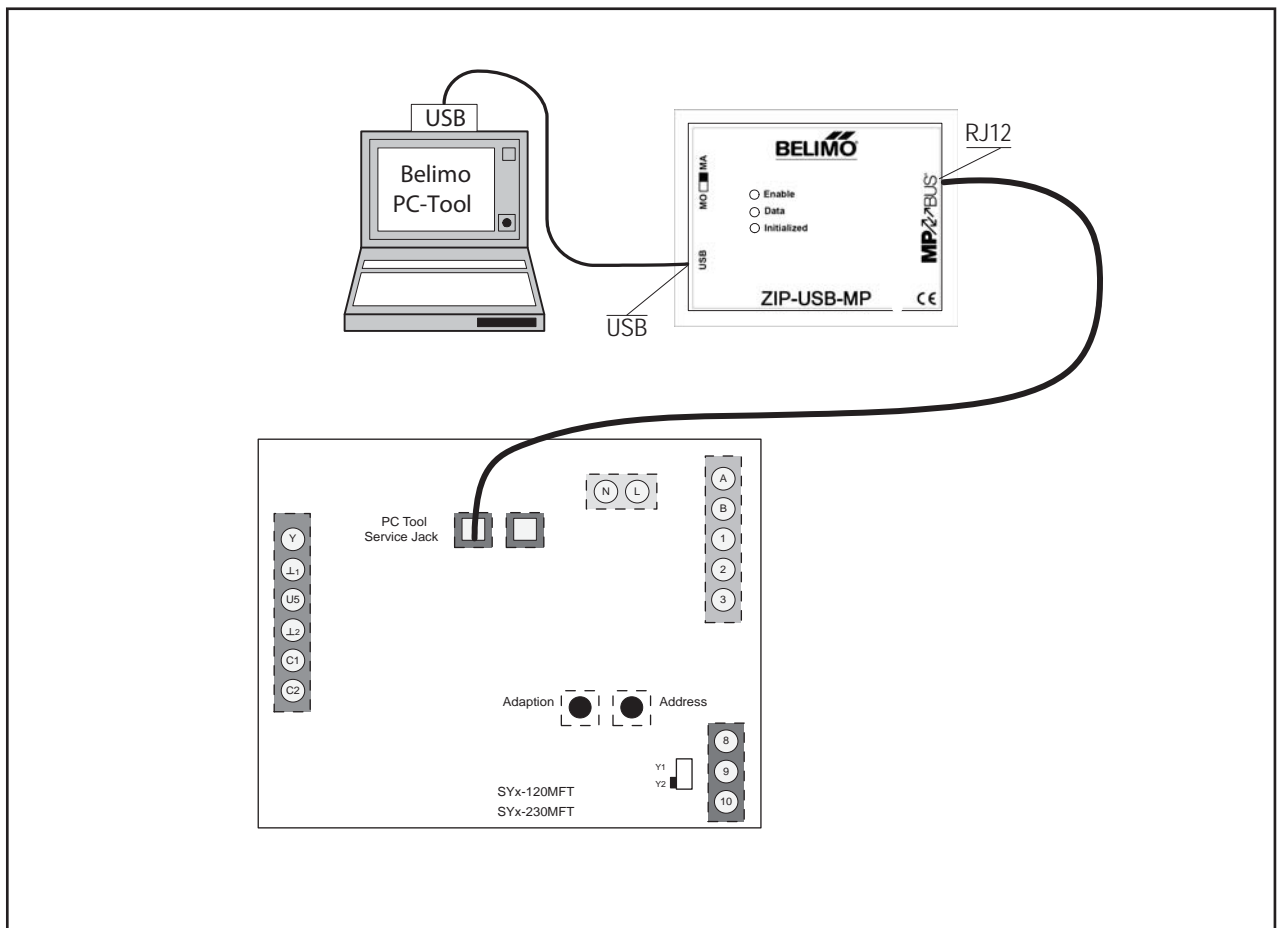

M40035 - 05/10 - Subject to change. © Belimo Aircontrols (USA), Inc.

## 2 Service

### 2.1 Displaying settings

The Service tab gives an overview of the current settings of the actuator.

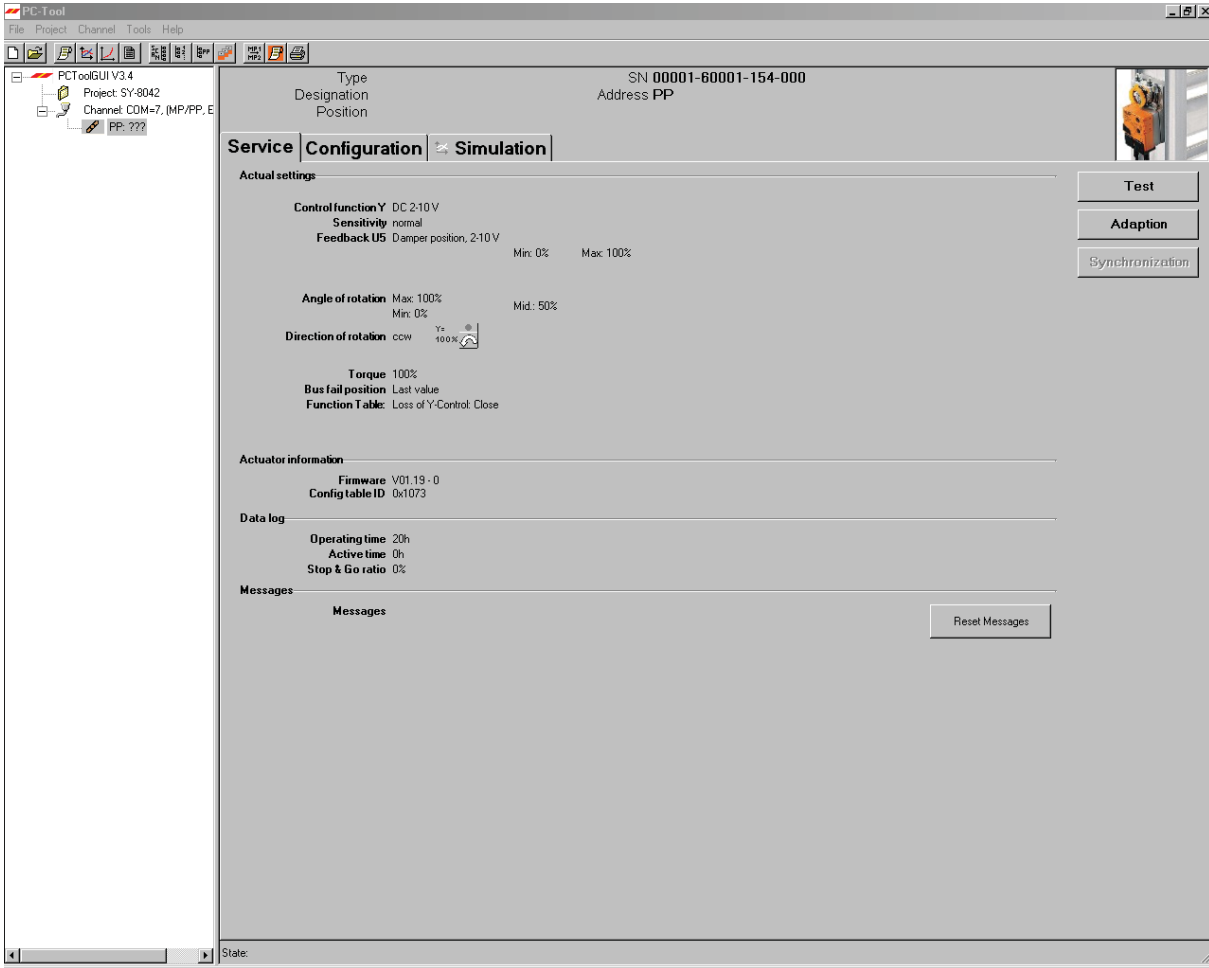

*Service tab for SY/MFT valve actuators*

### Meaning of the settings

Control signal Y	Type of control
Sensitivity	Response sensitivity and reversal hysteresis of the control function
Feedback U5	Type of feedback signal
Range	Position range within the mechanical limits
Running time	Time needed to pass through the position range
Stroke	Programmed stroke range: Max / Mid / Min
Direction of rotation	Clockwise/counterclockwise (for full-rotation actuators)
Direction of stroke	Plot of stroke direction to the positioning signal: Direct / inverted (in acc. with switch S3.1)
Switching point	Top / bottom (in acc. with switch S3.2)
Actuating force	In percent of the maximum positioning force
Behavior in the event of bus failure	Behavior when communication fails
Firmware	Software version on the actuator
Config table ID	Identification of the configuration table
Operating time	Number of hours during which the actuator was connected to the power supply
Active time	Number of hours during which the actuator was mechanically in motion and connected to the power supply
Stop & Go ratio	Ratio of active time/operating time in percent. A high Stop & Go ratio indicates an unstable control.

---

Running time, range, direction of rotation and stroke are not displayed on certain actuators.

---

## 2.2 Adaptation

In the adaptation, the actuator determines the range 0% ... 100% by approaching the mechanical limits.

Click the "Adaptation" button on the Service tab.

**Variant** You can also trigger the adaptation directly on the actuator. To do this, you have to remove the cover from the SY actuator. To trigger the adaptation, press the adaption button located on the electronic PCB.

The progress of the adaptation is displayed in the status line. The actuator first moves against the programmed direction to the zero stop and then to the end stop at full stroke.

Next, the absolute values for a programmatically limited angle of rotation range (minimum, mid-position, and maximum) as well as the feedback signal U5 are recalculated and displayed.



### 3 Configuration

On the "Configuration" tab, you can read out parameter values from the actuator, change them and save them back to the actuator. The valid ranges for the parameter values are displayed in parentheses next to the input boxes.

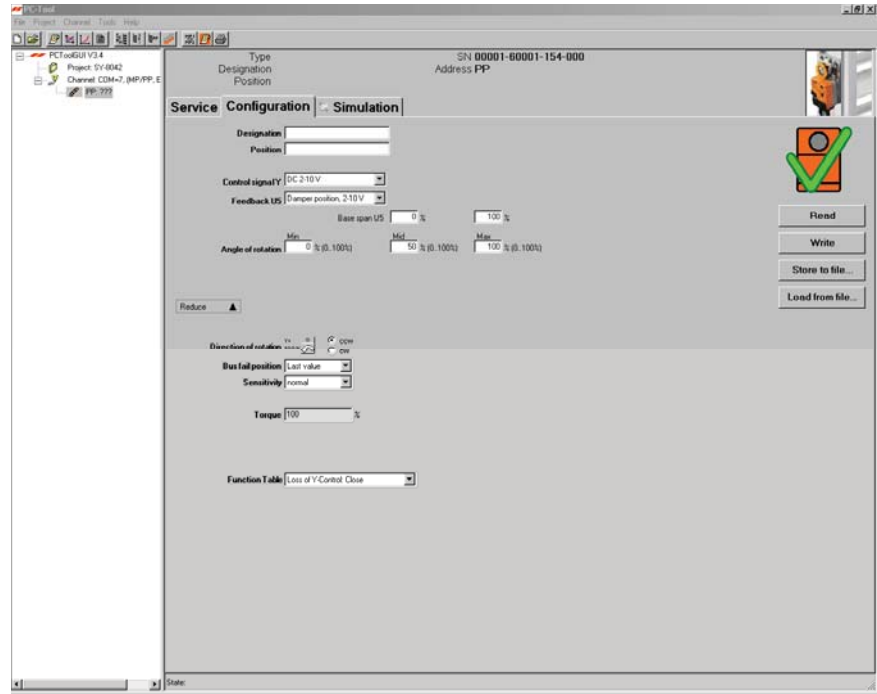

"Configuration" tab for SY-MFT actuators

Control Signal Y: Selectable: Options 2-10vdc, 0.5 – 10vdc, 4-20mA, DC Variable, 3 point\*, Open/Close\*  
 PWM 0.02-5s\*, PWM 0.10-25.5s\*, PWM 0.59-2.93s\*, PWM Variable\*  
 Feedback U5: Selectable: Options 2-10vdc, 0.5 – 10vdc, 4-20mA, DC Variable

\*Available on 24MFT Actuator Models only.

#### What is "Loss of Signal" functionality?

This is the point at which the SY actuator interprets no input from the controller and either stops, closes or opens the valve based on the programmed control functionality.

Loss of signal point is always at 0.5V. It doesn't matter if the control signal is 2-10V or 0.5-10V.

Loss of signal point is 1mA if 4-20mA is selected.

Loss of Signal – Stop The actuator will stop in its last position.

Loss of Signal – Open The actuator will move to its 100% position.

Loss of Signal – Close The actuator will move to its 0% position.

Loss of Signal – Nothing The actuator will move to the zero position.

Actuator number<sup>1</sup>

Designation	16 characters of any text
Position	16 characters of any text

<sup>1</sup> Only characters from the Western European character set are permitted for Description and Position (refer to page 1-53).

Control signal Y

3-point	AC voltage, positions: Open / neutral / closed
Open / closed	DC or AC voltage, 2-point
DC 0.5–10 V	(DC voltage) fixed operating range DC 0.5–10 V
DC 2–10 V modulating	(DC voltage) fixed operating range DC 2–10 V
DC variable	Start (Y=0%) 0.5 ... 30 Volt Stop (Y=100%) 2.5 ... 32 Volt Range between start and stop at least 2 V
PWM 0.02–5 s	Duration of the control impulse (pulse width modulation), fixed operating range
PWM 0.1–25.5 s	Duration of the control pulse, fixed operating range
PWM 0.59–2.93 s	Duration of the control pulse, fixed operating range
PWM variable	Start (Y=0%) minimum 0.02 seconds Stop (Y=100%) maximum 50 seconds

Feedback U5 (only active when the actuator address is set to PP)

Valve setting 2 -10V	DC voltage measurement signal, fixed range
Valve setting 0.5 -10V	DC voltage measurement signal, fixed range
Variable valve setting	DC voltage measuring signal Start 0.5...8.0 Volt / Stop 2.5 ... 10.0 V Range between start and stop at least 2 V

Scaling U5 (with "New Generation" actuator only)

Start	Position in percent, corresponds to the start value of the feedback signal
Stop	Position in percent which corresponds to the stop value of the feedback signal

Stroke

Min	Programmed lower limit of the range (cannot be changed)
Mid	Mid-position of range
Max	Programmed upper limit of the range

An existing value for Mid is automatically adapted when Max is entered: Mid is always less than or equal to this input value.

Examples of settings for control signal Y / feedback U5

**Control signal Y:** 3...8 V min: 30%, max : 70%  
**Feedback U5 :** 2...7 V start: 20%, stop: 90%

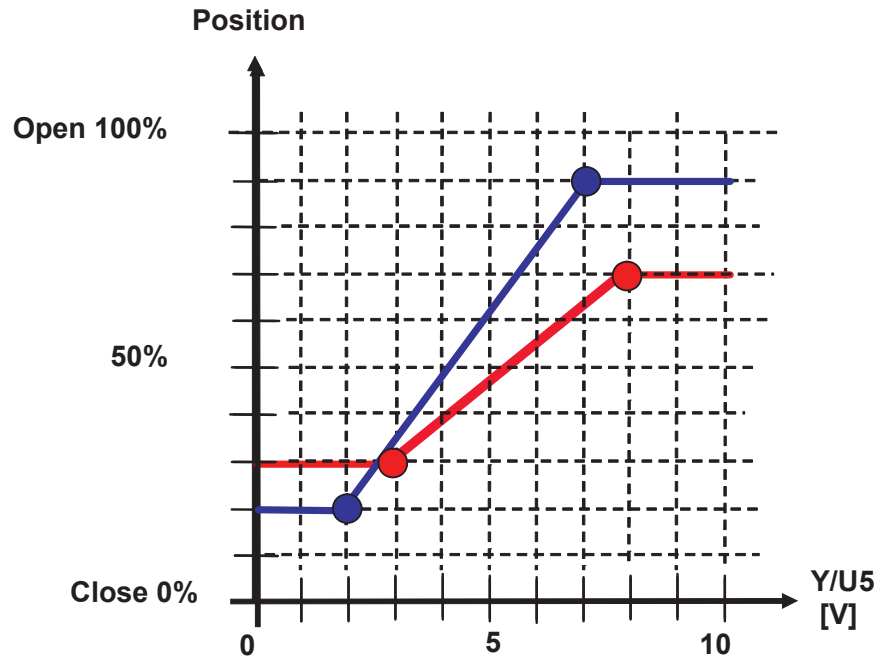

Running time

In seconds	Time needed to pass through the range limited by Min and Max (the valid range of values for the running time depends on the actuator type and the passed-through range)
------------	---

Stroke

Adapted	from the mechanical limits of certain stroke
Programmed	The valid values depend on the maximum nominal positioning range of the actuator

Stroke direction (in acc. with switch S3.1)

Direct	0% positioning signal is equivalent to 0% position feedback.
inverted	0% positioning signal is equivalent to 100% position feedback.

Closing point (in acc. with switch S3.2)

top	The linear spindle is moved into the actuator with the valve closed and the stem is moved out of the fitting.
bottom	The linear spindle is moved out of the actuator with the valve closed and the stem is moved into the fitting.

Behavior in the event of bus failure (currently cannot be changed)

Last setpoint	Position according to control signal Y
---------------	--

Sensitivity

Normal	
– Response sensitivity:	1% @ Operating range
– Reversal hysteresis	2.5% @ Operating range
Damped	
– Response sensitivity:	2% @ Operating range
– Reversal hysteresis	5% @ Operating range

Actuating force

25% ... 100%	Can be set in increments of 25%. 100% corresponds to the maximum positioning force for the actuator type (see nameplate)
--------------	--

## 4 Controller simulation

Go to the "Simulation" tab.

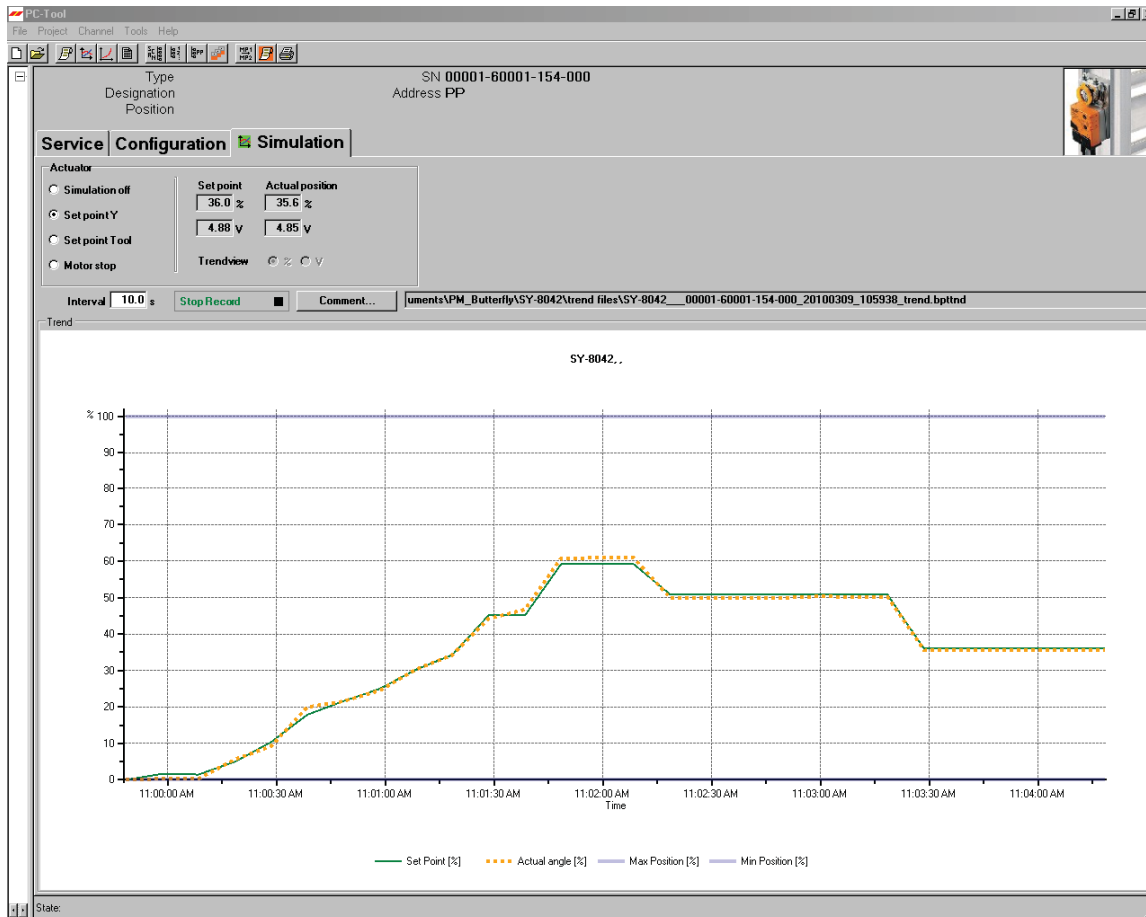

"Simulation" tab for SY-MFT actuators

The controller simulation is not possible while the actuator is performing an adaptation or synchronization.

### 4.1 Actuator control

Select the type of setpoint definition with the radio buttons.

- Setpoint Y (only available in PP mode): Control signal at connection Y according to selected control type (DC, PWM, open/close, 3-point).
- Setpoint Tool (not available with control type open/close or 3-point): The setpoint is entered in % of the programmed range. 0% is the minimum, 100% the maximum. The input values are converted and displayed in the units of the corresponding control signal (volts or seconds).

The control is switched off when you click Motor stop. This function is not available with the control types open/close and 3-point.

#### Measurement values

During the simulation, the stroke is displayed in % of the absolute (mechanically limited) range in millimeters and – converted according to the scale setting – as a feedback voltage in volts.

## 4.2 Trend recording

During simulation, the time progress of the setpoints and actual values can be displayed in a plot. The values are saved in a trend file and can be displayed again at a later time. Furthermore, you can add any comment texts you would like.

In the PC-Tool options "General", you determine whether the trend file is automatically saved when the recording is finished (checkbox not selected) or whether the program should ask you. The suggested file name can be modified before saving the file.

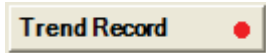

Click the "Trend Record" button during simulation. The display changes to a "flat" button. The recording stops when you click again.



The Trend View radio buttons allow you to set whether the display is given in percent of the full rotation range (%) or in volts (V).

The position is queried every second by default. You can change the query interval in an input box. The permitted values are 0 to 9999 seconds, whereby the value 0 means "no waiting time" (query as quickly as possible).

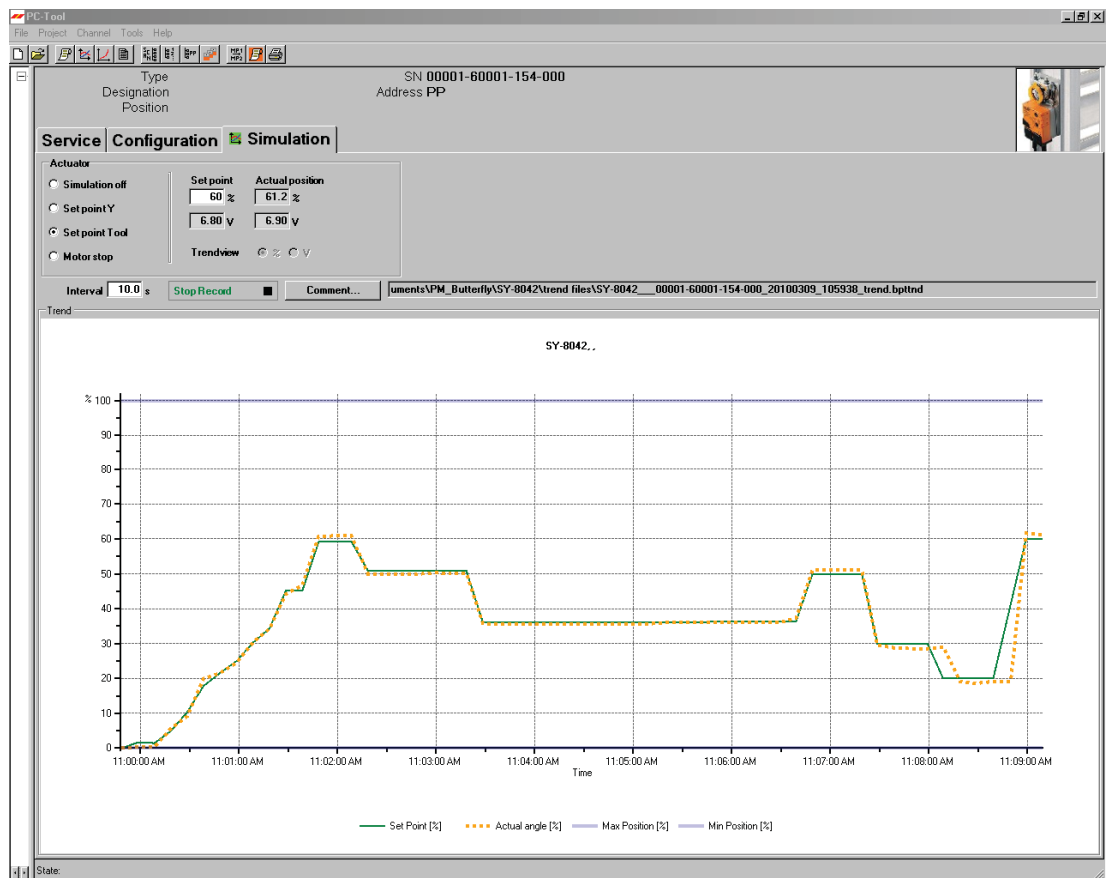

Trend plot

The Comment button allows you to enter a text at a defined time and the text is then saved in the trend file.

---

If you want to record a trend for more than one hour (long-term trend), enter a value of at least 2 seconds for the interval. If the interval is shorter, too many data points will result and the time for correcting the curve between the queries can become too short.

---



## 5 PC-Tool options

Select Tools▶PC-Tool options... in the main menu.

Variant Click the project in the outline bar [C] with the right mouse button and select PC-Tool options.

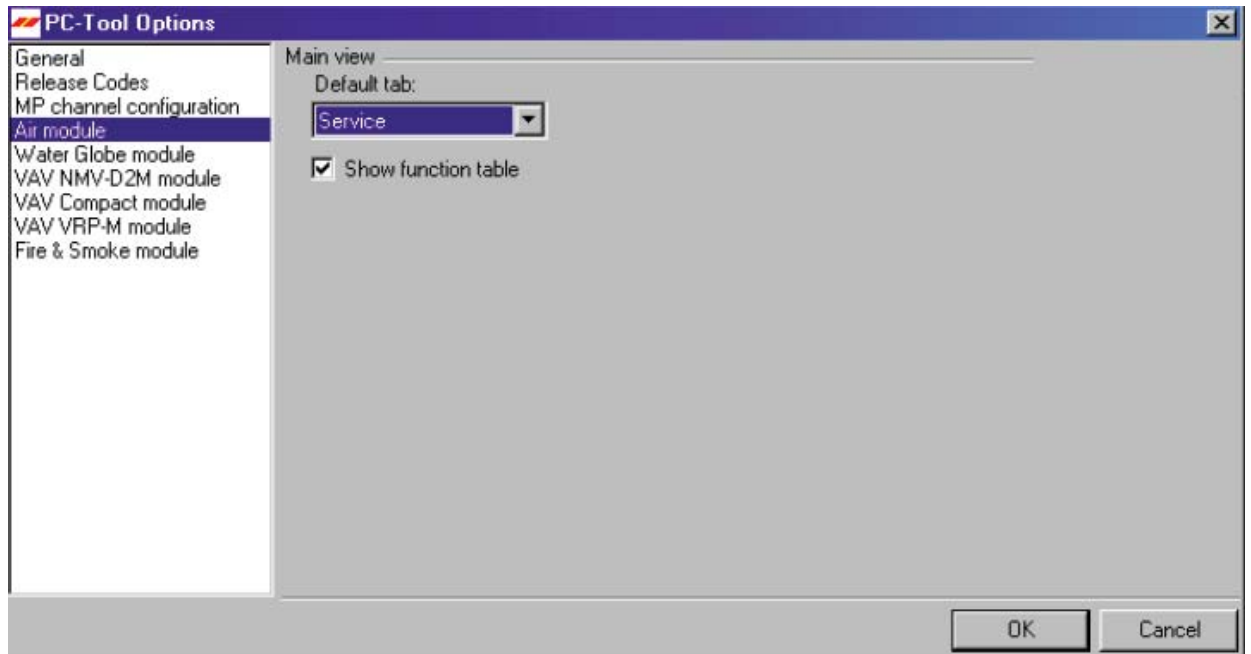

*Dialog for basic settings (Water module)*

Select "Air module" on the left.

Using the combo box "Default tab", you can select the index tab you want to open by default when starting the program PC-Tool.

Note: In PC-Tool Version 3.4, the "Show function table" should be selected. If this feature is not selected, the function table that is used to select the Loss of Signal position will not be available.

PC-Tool Version 3.5 is available and defaults with function table.



**USA**
**ACR Supply Company Inc.**

2719 Hillsborough Road  
Durham, NC 27705  
Phone: 919-286-2228

**With branches in NC**

**Aireco Supply**

9120 Washington Boulevard  
Savage, MD 20763-0414  
Phone: 301-953-8800

**With branches in MD, VA**

**Amcon Controls, Inc.**

11906 Warfield Street  
San Antonio, TX 78216  
Phone: 210-349-6161

**With a branch in Houston, TX**

**Applied Automation**

A Wilson Mohr Company  
3186 South Washington Street, #230  
Salt Lake City, UT 84115  
Phone: 801-486-6454

**Boston Aircontrols, Inc.**

8 Blanchard Road  
Burlington, MA 01803  
Phone: 781-272-5800

**Charles D. Jones Co.**

445 Bryant Street, Unit #1  
Denver, CO 80204-4800  
Phone: 800-777-0910

**With branches in CO, MO, KS**

**Climatic Control Div/ICD**

5061 W. State Street  
Milwaukee, WI 53208  
Phone: 800-242-1656

**With branches in WI**

**Cochrane Supply and Engineering, Inc.**

30303 Stephenson Highway  
Madison Heights, MI 48071-1633  
Phone: 800-482-4894

**With branches in MI and Maumee, OH**

**Columbus Temperature Control**

1053 E. 5th Avenue  
Columbus, OH 43201  
Phone: 800-837-1837

**Controlco**

5600 Imhoff Drive, Suite G  
Concord, CA 94520  
Phone: 925-602-7728

**With branches in CA, NV**

**Edward C. Smyers & Co.**

223 Fort Pitt Boulevard  
Pittsburgh, PA 15222-1505  
Phone: 412-471-3222

**Engineered Control Systems**

4805 N.W. 79th Avenue  
Suite 11  
Miami, FL 33166  
Phone: 305-418-8901

**With branches in FL**

**First Source Distributors, LLC**

710 Peninsula Lane, Suite E  
Charlotte, NC 28273  
Phone: 800-670-5977

**G & O Thermal Supply**

5435 N. Northwest Highway  
Chicago, IL 60630  
Phone: 773-763-1300

**With branches in IL**

**Industrial Controls Distributors LLC**

1776 Bloomsbury Avenue  
Wanamassa, NJ 07712  
Phone: 800-631-2112

**With branches in  
GA, KY, IN, MA, ME, NC, NY, OH, PA, TN**

**Interstate HVAC Controls**

30 Vineland Street  
Brighton, MA 02135  
Phone: 617-782-9000

**Jackson Controls**

1708 E. 10th Street  
Indianapolis, IN 46201  
Phone: 317-231-2200

**M & M Controls**

9E West Aylesbury Road  
Timonium, MD 21093  
Phone: 410-252-1221

**With a branch in Alexandria, VA**

**MICONTROLS, Inc.**

6516 5th Place South  
Seattle, WA 98124  
Phone: 800-877-8026

**With branches in WA, OR**

**Meier Supply**

123 Brown Street  
Johnson City, NY 13790  
Phone: 607-797-7700

**With branches in NY, PA**

**Minvalco, Inc.**

3340 Gorham Avenue  
Minneapolis, MN 55426-4267  
Phone: 952-920-0131

**With branches in MN**

**RSD/Refrigeration Supply Distribution**

26021 Atlantic Ocean Drive  
Lake Forest, CA 92630  
Phone: 949-380-7878

**With branches in  
CA, NV, OR, AK, AZ, ID, UT, WA, MT**

**Saint Louis Boiler Supply, Co.**

617 Hanley Industrial Court  
St. Louis, MO 63144  
Phone: 314-962-9242

**South Side Control Supply, Co.**

488 N. Milwaukee Avenue  
Chicago, IL 60610-3923  
Phone: 312-226-4900

**With branches in IL, IN**

**Stromquist and Company**

4620 Atlanta Road  
Smyrna, GA 30080  
Phone: 404-794-3440

**With a branch in Orlando, FL**

**Temperature Control Systems**

10315 Brockwood Road  
Dallas, TX 75238  
Phone: 214-343-1444

**With branches in OK, TX**

**Tower Equipment Co., Inc.**

1320 West Broad Street  
Stratford, CT 06615  
Phone: 800-346-4647

**Twinco Supply Corporation**

55 Craven Street  
Huntington Station, NY 11746-2143  
Phone: 800-794-3188

**With branches in NY**

**CANADA**

For a complete list of distributors  
in Canada, please visit our  
website: [www.belimo.ca](http://www.belimo.ca)  
or call toll free: 866-805-7089

Belimo worldwide: [www.belimo.com](http://www.belimo.com)

**BELIMO Americas**

**USA Locations**, 43 Old Ridgebury Road, Danbury, CT 06810

Tel. 800-543-9038, Fax 800-228-8283, [marketing@us.belimo.com](mailto:marketing@us.belimo.com)

1049 Fortunado Loop, Sparks, NV 89436

Tel. 800-987-9042, Fax 800-987-8875, [marketing@us.belimo.com](mailto:marketing@us.belimo.com)

**Canada Locations**, 14/16 – 5716 Coopers Avenue, Mississauga, Ontario L4Z 2E8

Tel. 866-805-7089, Fax 905-712-3124, [marketing@us.belimo.com](mailto:marketing@us.belimo.com)

**Latin America and The Caribbean Customer Service**

Tel. 203-791-8396, Fax 203-791-9139, [marketing@us.belimo.com](mailto:marketing@us.belimo.com)

