

OpenAir™ GGD Electronic Damper Actuator

Designed for UL Listed Fire/Smoke and Smoke Control Dampers

2-Position, 15-second Runtime 15-second Spring Return Time



Description

The OpenAir™ direct coupled, fast acting, two-position, spring return electronic actuators are available as 24 Vac, 115 Vac, and 230 Vac models. They are intended for use on UL listed smoke control dampers or combination fire/smoke rated dampers.

Features

- High temperature rated drive system.
- Reversible fail-safe spring return.
- All metal housing.
- Teflon® insulated lead wires.
- Mechanical range adjustment.
- Multiple shaft couplings available; will accommodate up to 1.05-inch shafts.
- Fifteen second nominal open time; 15-second nominal spring return time.

Application

This actuator is used for the control of dampers requiring up to 142 lb-in (16Nm) driving torque. It is intended for control of UL listed smoke control dampers or combination fire/smoke HVAC dampers. This actuator is designed to meet the 1999 revisions to the UL 555S and AMCA 500-D specifications. Minimum stall torque 350 lb-in.



Product Numbers

Table 1.

| Type | Rotation | Shaft Adapter | 24 Vac | 115 Vac | 230 Vac |
|-----------------------------|----------|----------------|-------------|-------------|-------------|
| Standard | 95° | Self-centering | GGD121.1U | GGD221.1U | GGD321.1U |
| Eight pack of standard | 95° | Self-centering | GGD121.1U/B | GGD221.1U/B | GGD321.1U/B |
| With oversize shaft adapter | 95° | Oversized | GGD121.3U | GGD221.3U | GGD321.3U |

| | | |
|-----------------------------|--|--|
| Specifications | Operating voltage | 24 Vac \pm 20% |
| | Power supply | 115 Vac \pm 15% |
| | | 230 Vac \pm 10% |
| | Frequency | 50/60 Hz |
| | Power consumption | |
| | running | 150 VA |
| | holding | 10 VA |
| Function | Running torque | 142 lb-in (16 Nm) |
| | Spring return torque | 108 lb-in (12 Nm) |
| | Minimum stall torque | 350 lb-in (39 Nm) |
| | Torque reduction at elevated temperature | Less than 10% |
| | Runtime for 90° | |
| | operating with motor at 60 Hz | 15 seconds nominal |
| | closing (on power loss) with spring return | 15 seconds maximum |
| | Nominal angle of rotation | 95° |
| Life Expectancy | | Minimum 35,000 full stroke cycles. |
| Mounting | Damper shaft size | |
| | Standard | 3/8 to 1 inch (8 to 25.6 mm) |
| | Oversize | 1.05 inch maximum (26.6 mm) |
| | Minimum shaft length | 3/4-inch (20 mm) |
| Housing | Enclosure | NEMA 1 |
| | Material | Die cast aluminum alloy |
| Ambient conditions | Ambient temperature | |
| | operation | 0 to 130°F (-18 to 55°C) One time 350°F (177 °C) for 1/2 hour (per UL555S) |
| | storage and transport | -25 to 158°F (-32 to 70°C) |
| | Ambient humidity (non-condensing) | Maximum 95% R.H. |
| Agency certification | | UL listed to UL873 cUL certified to Canadian standard C22.2 No. 24-93 Australian EMC Framework (C-tick) with the limits per AS/NZS 2064 1/2:1997 |
| Miscellaneous | Pre-cabled connection | 18 AWG |
| | Dimensions | See <i>Figure 1</i> . |
| | Weight | \approx 7 lbs. (3.2 kg) |
| | Eight pack | \approx 56 lbs. (25.4 kg) |

Warning/Caution Notations

| | | |
|-----------------|---|--|
| WARNING |  | Personal injury/loss of life may occur if you do not perform a procedure as specified. |
| CAUTION: |  | Equipment damage may occur if you do not follow a procedure as specified. |

Accessories

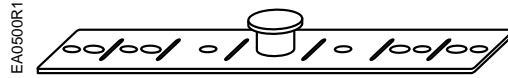

985-006 Anti-rotation (mounting) bracket.

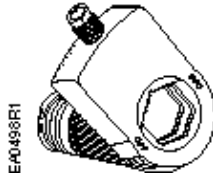

985-004
 Self-centering shaft adapter.



ASK74.1 Oversized shaft adapter will accommodate up to a 1.05-inch (26.6 mm) diameter shaft. Use for coupling to 1-inch jackshafts that are slightly oversized.

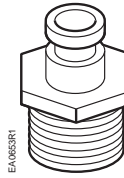

985-035P25 Conduit adapter for accommodating a conduit box (pk of 25).



985-008P20 Conduit adapter for a 1/2-inch (12 mm) NPT connector (pk of 20).

Operation

When power is applied, the actuator coupling moves toward the open position, “90°”. The actuator opens in fifteen seconds nominal, 90° at 60 Hz. In the event of a power failure or when operating voltage is turned off, the actuator returns to the “0” position. The return time is fifteen seconds maximum for 90°.

The GGD actuator does not require any periodic cycling to function properly as an integral part of an active smoke control damper system.

NOTE: Siemens Building Technologies, Inc. however, strongly suggests that all life safety systems are functionally checked periodically. Check the smoke control damper/actuator every time you functionally check your smoke detectors, emergency lights, and/or power generators for operation.

Installation

Refer to the installation instructions for detailed guidelines.



CAUTION:

Read and carefully follow the *Installation Instructions* (129-255) to avoid equipment damage.

Wiring

All wiring must conform to NEC and local codes and regulations.

Wire Designations

24 Vac

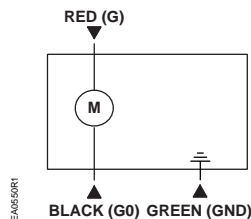

| Function | Color |
|--------------|-------|
| Supply (SP) | Red |
| Neutral (SN) | Black |
| Ground | Green |

115 Vac

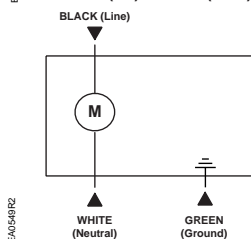

| Function | Color |
|----------|-------|
| Line | Black |
| Neutral | White |
| Ground | Green |

**Wire Designations,
 continued**

230 Vac

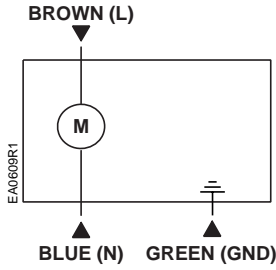

| Function | Color |
|----------|-------|
| Line | Brown |
| Neutral | Blue |
| Ground | Green |



CAUTION:

The actuator must be wired with a 230 Vac line with respect to neutral and the ground lead must be connected for proper protection of the actuator. Any other connection, such as phase to phase, can damage the actuator.

Service



WARNING:

Do not open the actuator. Personal injury may occur if opened. Opening the actuator voids the warranty.

If the actuator is inoperative, replace the unit.

Dimensions

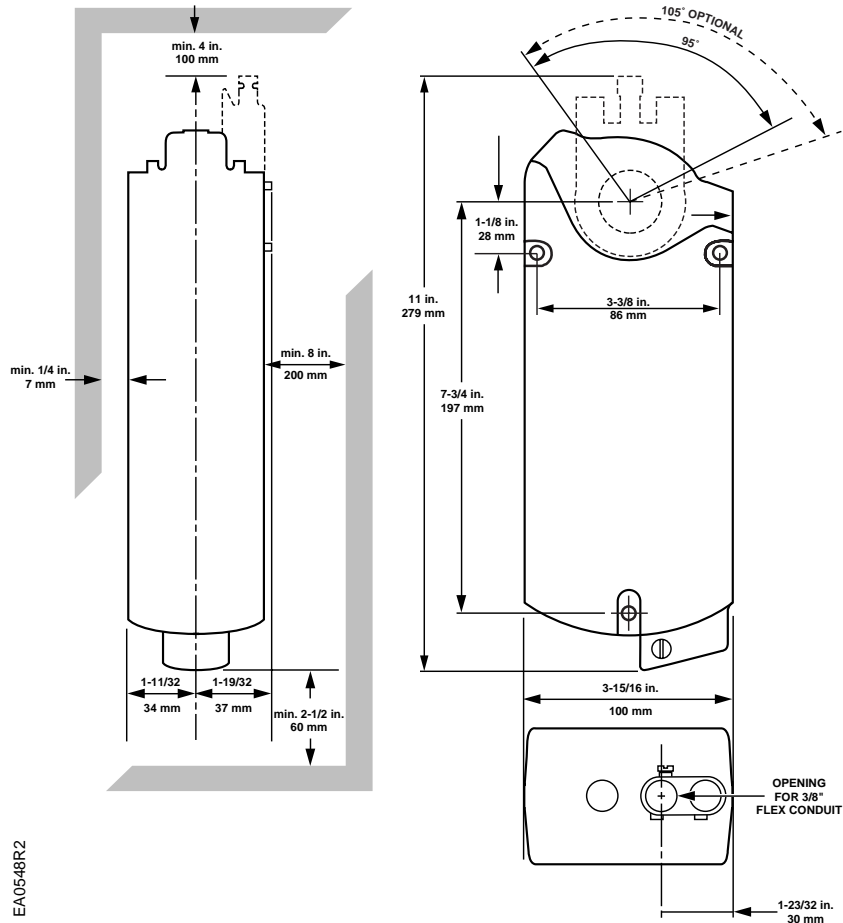

Figure 1. Dimensions of the Actuator.

Information in this publication is based on current specifications. The company reserves the right to make changes in specifications and models as design improvements are introduced. Teflon is a registered trademark of DuPont. OpenAir is a trademark of Siemens Building Technologies. Product or company names mentioned herein may be the trademarks of their respective owners. © 2008 Siemens Building Technologies, Inc.