

E³Point PRODUCT SUBMITTAL

Toxic and Combustible Gas Detector Standalone Platform (Single or Dual-Gas Monitoring)

ORDERING INFORMATION

Single-Gas Configuration: Base Unit, Surface-Mount

* Base unit and sensor cartridge sold together ** Base unit only; sensor cartridge sold separately

Part Number	Description
<input type="checkbox"/> E3SASCO*	E ³ Point, CO sensor cartridge, Surface-mount, 24Vac/dc, -20 to 50°C (-4 to 122°F)
<input type="checkbox"/> E3SA**	E ³ Point, Surface-mount, 4-20mA, 24Vac/dc, -40 to 50°C (-40 to 122°F)
<input type="checkbox"/> E3SAHSCO*	E ³ Point, CO sensor cartridge, Surface-mount, 120Vac, -20 to 50°C (-4 to 122°F)
<input type="checkbox"/> E3SAH**	E ³ Point, Surface-mount, 4-20mA, 120Vac, -40 to 50°C (-40 to 122°F)

Dual-Gas Configuration: Base Unit w/Remote Sensor Capability, Surface-Mount

Part Number	Description
<input type="checkbox"/> E3SARSCO*	E ³ Point, CO sensor cartridge, Surface-mount, 24Vac/dc, Dual-mode, -20 to 50°C (-4 to 122°F)
<input type="checkbox"/> E3SAR**	E ³ Point, Surface-mount, 4-20mA, 24Vac/dc, Dual-mode, -40 to 50°C (-40 to 122°F)
<input type="checkbox"/> E3SARHSCO*	E ³ Point, CO sensor cartridge, Surface-mount, 120Vac, Dual-mode, -20 to 50°C (-4 to 122°F)
<input type="checkbox"/> E3SARH**	E ³ Point, Surface-mount, 4-20mA, 120Vac, Dual-mode, -40 to 50°C (-40 to 122°F)

Remote Sensors (always sold with sensor cartridge included)

Part Number	Description
<input type="checkbox"/> E3SRMCO	E ³ Point, Remote Sensor, -20 to 50°C (-4 to 122°F), Carbon Monoxide
<input type="checkbox"/> E3SRMNO2	E ³ Point, Remote Sensor, -20 to 50°C (-4 to 122°F), Nitrogen Dioxide
<input type="checkbox"/> E3SRMH2S	E ³ Point, Remote Sensor, -20 to 50°C (-4 to 122°F), Hydrogen Sulfide
<input type="checkbox"/> E3SRMH2	E ³ Point, Remote Sensor, -20 to 50°C (-4 to 122°F), Hydrogen
<input type="checkbox"/> E3SRMO2	E ³ Point, Remote Sensor, -20 to 50°C (-4 to 122°F), Oxygen
<input type="checkbox"/> E3SRMM	E ³ Point, Remote Sensor, -20 to 50°C (-4 to 122°F), Methane
<input type="checkbox"/> E3SRMP	E ³ Point, Remote Sensor, -20 to 50°C (-4 to 122°F), Propane

Stand-Alone Platform, Duct-Mount

Part Number	Description
<input type="checkbox"/> E3DASCO*	E ³ Point, CO, Duct-mount, 24Vac/dc, -20 to 50°C (-4 to 122°F)
<input type="checkbox"/> E3DA**	E ³ Point, Duct-mount, 4-20mA, 24Vac/dc, -40 to 50°C (-40 to 122°F)

Sensor Cartridges

Part Number	Description
<input type="checkbox"/> E3SCO	CO Cartridge -20 to 50°C (-4 to 122°F), Carbon Monoxide
<input type="checkbox"/> E3NO2	NO ₂ Cartridge -40 to 50°C (-40 to 122°F), Nitrogen Dioxide
<input type="checkbox"/> E3H2S	H ₂ S Cartridge -40 to 50°C (-40 to 122°F), Hydrogen Sulfide
<input type="checkbox"/> E3H2	H ₂ Cartridge -40 to 50°C (-40 to 122°F), Hydrogen
<input type="checkbox"/> E3O2	O ₂ Cartridge -40 to 50°C (-40 to 122°F), Oxygen
<input type="checkbox"/> E3M	CH ₄ Cartridge -40 to 50°C (-40 to 122°F), Methane
<input type="checkbox"/> E3P	C ₃ H ₈ Cartridge -40 to 50°C (-40 to 122°F), Propane

EXAMPLES OF HOW TO ORDER

To order a stand-alone version, surface-mount, analog, CO detector, -20 to 50°C (-4 to 122°F): Order E3SASCO

To order a stand-alone version, surface-mount, analog, dual-gas CO + NO₂, -20 to 50°C (-4 to 122°F): Order E3SARSCO + E3SRMNO2

To order a stand-alone version, duct-mount, analog, propane detector, -40 to 50°C (-40 to 122°F): Order E3DA + E3P

To order a stand-alone version, surface-mount, analog, dual-gas CO + C₃H₈, 120Vac, -20 to 50°C (-4 to 122°F): Order E3SARHSCO + E3SRMP

SPECIFICATIONS

General Specifications

Uses

Wall or duct-mounted gas detector for monitoring carbon monoxide (CO), nitrogen dioxide (NO₂), oxygen (O₂), methane (CH₄), hydrogen (H₂), hydrogen sulphide (H₂S), and propane (C₃H₈), installed as a standalone device with single-gas or dual-gas monitoring. **(Note: E³Point standalone version replaces Vulcain models VA201T, VA201M and VA301M)**

Size	20.56 x 14.90 x 6.72cm (8.09 x 5.87 x 2.65") (H x W x D); Remote Sensor: 3.5 x 4.5 x 6.5 cm (1.36 x 1.75 x 2.56")
Power Requirement	24 Vac nominal (17-27Vac), 50/60 Hz, 0.35A; 24Vdc nominal (20-38Vdc); with remote sensor: 7 W max.
Optional Main AC Input	120Vac nominal, +/- 10% (with on-board transformer)
Relay Output	2 DPDT relays, 5A @ 250Vac; 5A @ 30Vdc
Communications	4-20mA
Operating Environment	Commercial, Indoor, Extreme Temperature Environments
Operating Temperature	H ₂ S, NO ₂ , O ₂ , CH ₄ , H ₂ , C ₃ H ₈ : -40 to 50°C (-40 to 122°F) CO: -20 to 50°C (-4 to 122°F); future available CO version: -40 to 50°C (-40 to 122°F)
Sensor Type	Electrochemical cell (CO, NO ₂ , H ₂ S, O ₂); catalytic (CH ₄ , H ₂ , C ₃ H ₈)
Display	8 character, 2 line backlit LCD
Visual Indicators	Green LED: Power Amber LED 1: Alarm/Fault Amber LED 2: Alarm/Fault
Audible Alarm	>85 dBA at 3 m (10 ft)
Accuracy	+/- 3% of full scale @ 25 C



Detection Ranges and Alarm Levels

Gas	Resolution	Range	Alarm A	Alarm B	Alarm C
CO (Carbon monoxide)	1 ppm	0-250 ppm	25 ppm	200 ppm	225 ppm
H ₂ S (Hydrogen sulfide)	0.1 ppm	0-50 ppm	10 ppm	15 ppm	20 ppm
NO ₂ (Nitrogen dioxide)	0.1 ppm	0-10 ppm	0.7 ppm	2 ppm	9 ppm
O ₂ (Oxygen)	0.1% vol.	0-25% vol.	19.5% vol.	22% vol.	22.5% vol.
H ₂ (Hydrogen)	0.5% LEL	0-100% LEL	25% LEL	50% LEL	90% LEL
CH ₄ (Methane)	0.5% LEL	0-100% LEL	25% LEL	50% LEL	90% LEL
C ₃ H ₈ (Propane)	0.5% LEL	0-100% LEL	25% LEL	50% LEL	90% LEL

Enclosure

Polycarbonate

Certification

 CSA C22.2 No. 61010-1,  UL us UL 61010-1; FCC part 15; ICES-003 issue 4

Wall Mounting

Mounting is usually done on concrete walls or columns, but the unit can be mounted on any vertical surface. The housing is designed with spacers on the back to allow moisture to flow behind the housing without affecting the unit.

- Mounting holes are located inside the housing. Open the unit to access mounting holes.
- Drill and mark the holes, as shown:
 - Width 11.1 cm (4 3/8") apart (if mounting directly to wall)
 - Height 8.3 cm (3.281") for electrical boxes

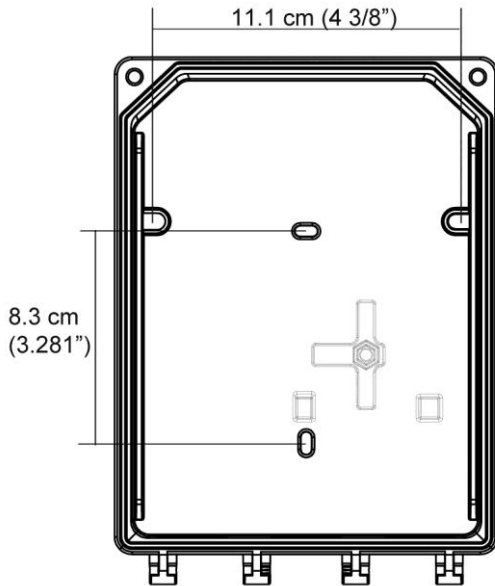

Figure 1. Unit Dimensions

- Pre-drill mounting holes from the back of the unit as needed.
- Securely mount the unit using the appropriate screws and anchors. The unit is designed to use #6 screws. Tighten to 8.7 in-lb (1 Nm) maximum.
- Close the unit cover and tighten screws to 29.7 in-lb (3 Nm).
- Do not remove PC board when removing knockouts.
- Knockout on back is not for conduit entry.

General Mounting Considerations:

- Must be easily accessible for calibration and maintenance.
- Mount the sensor close to the potential leak source for fastest possible leak detection.
- If personnel protection is the primary application, mount in the "breathing zone" (1–1.5m from the ground, within the range of a person's respiration area).
- Protect the sensor from water, excessive humidity, and washdown.
- Take air movement and ventilation patterns into account.
- To prevent electrical interference, keep sensor and wire runs away from mercury vapor lights, variable speed drives, and radio repeaters.
- Protect the sensor from physical damage (fork lifts, etc.).
- Do not mount the sensor over a door in a refrigerated area.
- For highly critical locations, more than one sensor should be installed in each room.

Very Important:

- **Never** mount the sensor flat on a ceiling.
- **Never** mount the sensor on a vibrating surface.

Duct Mounting

Special Duct Mount Installation

This option works best for airflows between 500–4000 ft./min. The E3Point must be duct mounted using the custom box

provided with the duct mount version. All of the components housed within the box are factory assembled.

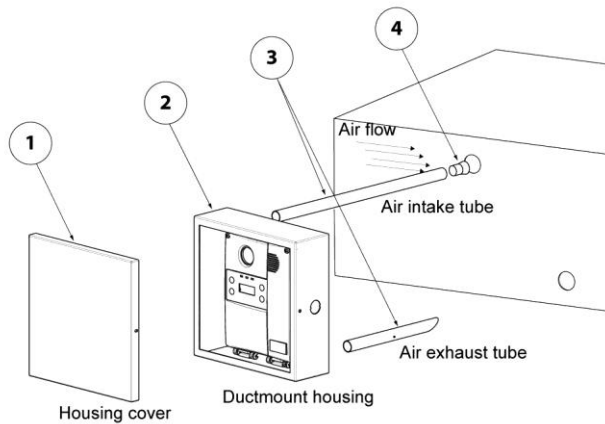

Figure 2. Duct Mounting

1. Select the location for the unit.
2. Measure and mark the holes for intake and exhaust tubes.
3. Drill the holes for the sampling tubes (making sure holes are large enough for plug).
4. Affix intake and exhaust tubes to the mounting box.
5. Insert the tubes into the holes on the ducting.
6. Screw the mounting box onto the duct.
7. Remove the desired knock out (depending on where cables will enter box) and affix appropriate conduit.
8. Run wiring through the conduit and duct mount box to the unit. Connect wires according to the Wiring Details.
9. Screw cover onto the E3Point and replace the cover on the mounting box.

Ensure to orient the air holes on the air intake tube to face the airflow.

Wiring

Guidelines

Electrical wiring must comply with all applicable codes. Operating conditions and site equipment that may be involved should be discussed with local operating personnel to determine if any special needs should be considered.

Ground the shield at the main control panel. Connect the shield wire in the sensor terminal block labeled **shield**. Tape all exposed shield wire at the sensor to insulate it from the enclosure.

Electrical Power: 24 VDC/VAC nominal, 0.35 amp maximum. Either AC or DC may be connected to the terminal block.

Output: Circuit board mounted sensor provides a linear 4-20 mA output. Monitoring equipment may have a maximum impedance of 500 ohms.

Wire: Signal wiring should be done with #20-24 AWG shielded twisted pair cable Belden 9841 or similar. Network units should have no more than 2,000 ft (600 m) of #22 AWG wire. Smaller gauge sizes are limited by the same resistance limit. Power wiring should be sized by local codes, but never less than #20 AWG. 120 VAC wiring should be #14 or #12 AWG.

Wiring Diagrams

Circuit Board Connections

- Connect the power wiring to terminal J1
- Connect Communication wiring to terminal J2
- Connect external device (ventilator, strobe, etc.) to relay terminals J5, J6

3-Wire Current Sink Output

(VDC only)

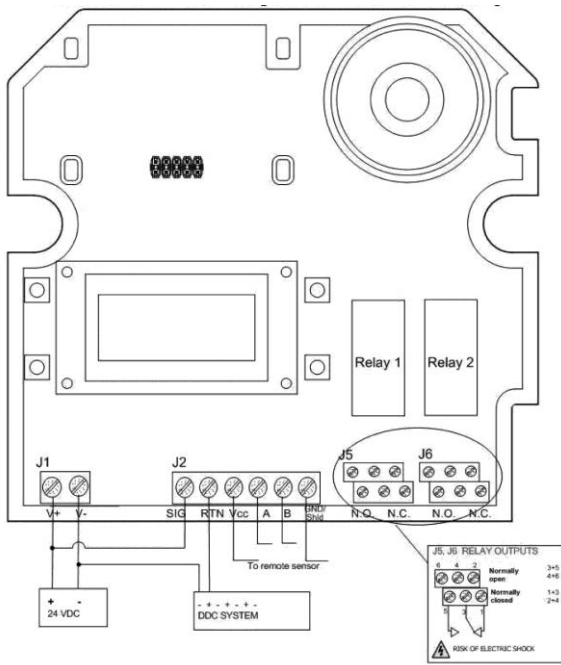

Figure 3. 3-Wire Current Sink Output

4-Wire Current Source Output

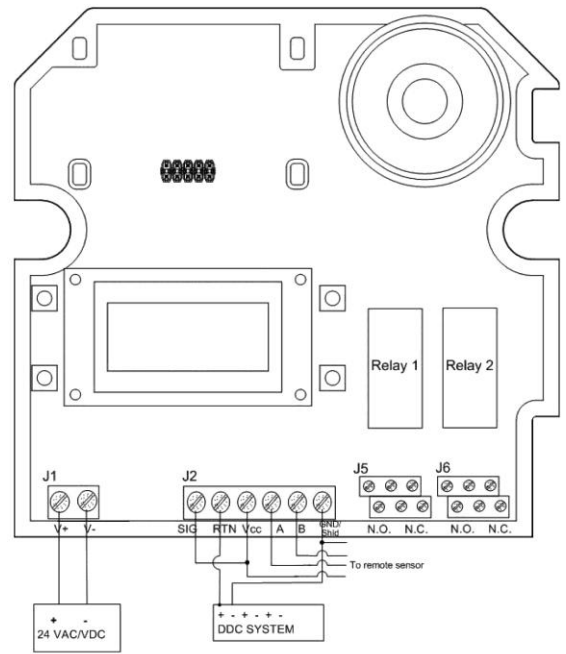

Figure 4. 4-Wire Current Source Output

4-Wire Current Sink Output

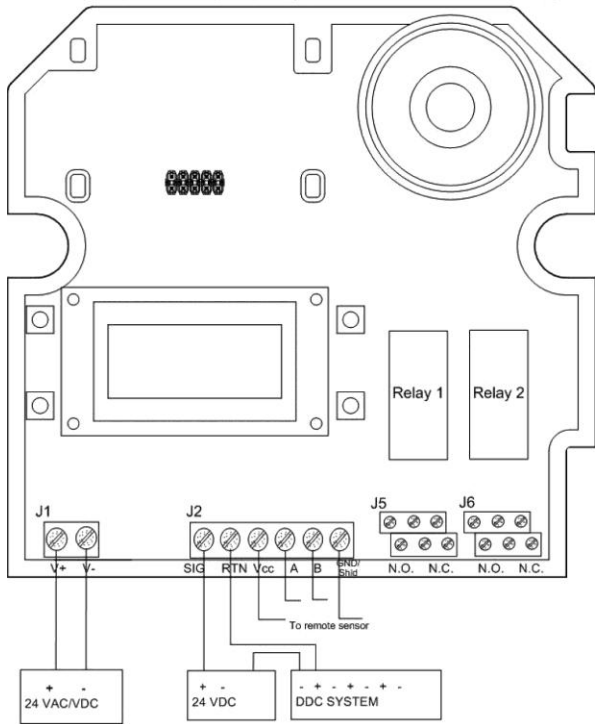

Figure 5. 4-Wire Current Sink Output

120 VAC Connection

The transformer is mounted under the PCB and connections to the power terminal are factory wired. Connect the live and neutral wires, as shown (ensure that power is off before attempting to connect the wires). Replace fuse with same type: 1A 250 VAC, T.

