

# Crankcase Heaters

MARS SERIES **324**

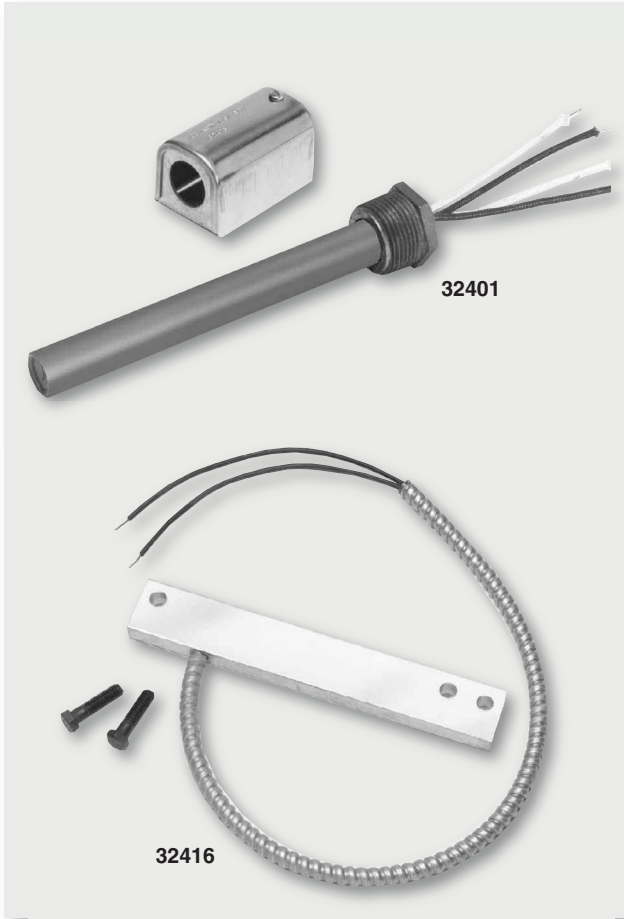

## Direct Replacement Crankcase Heaters for Copeland

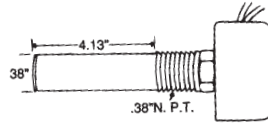

FIGURE 1

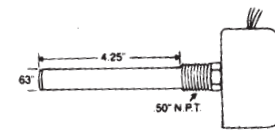

FIGURE 2

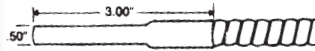

FIGURE 3

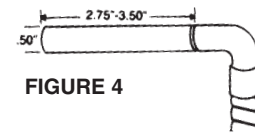

FIGURE 4

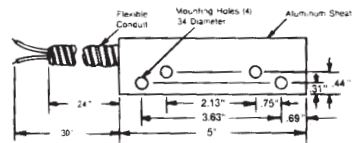

FIGURE 5

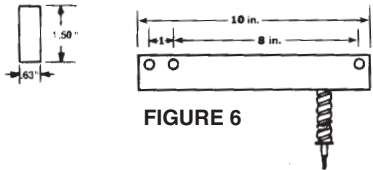

FIGURE 6

## Crankcase Heaters for Copeland

NOTE: All heaters requiring clips or brackets are packaged with the appropriate clips or brackets required.

MARS NO.	COPELAND NO.	WATTS	VOLTS	HEATER LENGTH IN.	FIGURE	COMPRESSOR MODEL	ACCESSORIES
32401	518-0001-01						2 bolts
32403	518-0001-02	65	240	4.13	1	3D,9D,9R	
32405	518-0001-03						2 bolts
32408	518-0002-01						
32409	518-0002-02	100	240	4.25	2	4R,6R,6T,4D,6D	
32410	518-0002-03						
32416	518-0009-01	65	240	10.00	6	E,9R,9W,MW,3A,3R,LA,MR,NR	
32429	018-0029-00	60	240	3.00	3	BR	
32431	018-0021-04		120				
32432	018-0021-05	200	240	3.50	4	6RJ,4RJ,4RR	
32437	018-0023-01		240				
32439	018-0023-00	50	120	5.00	5	K & H	