

Contents

How to Select the Butterfly Retrofit Solution pg 83
 Butterfly Valve Retrofit Actuators pg 84

Solutions for Specific Manufacturer and Part Number

Apollo pg 86
 Belimo pg 87
 Bray pg 89
 Centerline pg 91
 Challenger pg 94
 Chemtrol pg 95
 Dezurik pg 96
 Flowseal pg 98
 FNW pg 99
 Gruvlok pg 100
 Hammond pg 102
 Jamesbury pg 103
 Jenkins pg 105
 Johnson Controls pg 106
 Keystone pg 107
 Keystone K-LOK pg 109
 Metraflex pg 111
 Milwaukee pg 112
 Mueller pg 114
 Nibco pg 115
 PDC pg 116
 Quartermaster pg 117
 Victaulic pg 118
 Watts pg 120

Custom Butterfly Valve Retrofit Solutions, Instructions pg 121
 Custom Butterfly Valve Retrofit Solution Form pg 122
 Component Identification pg 123
 UFLK/UFSP Retrofit Solution (2-Way Valves) pg 126
 SY...Series Butterfly Retrofit Solution (2-Way Valves) pg 128
 UFLK/UFSP Retrofit Solution (3-Way Valves) pg 133
 SY...Series Butterfly Retrofit Solution (3-Way Valves) pg 136
 Valve Accessories pg 144
 Custom Ball Valve Retrofit Solutions, Instructions pg 145
 Custom Ball Valve Retrofit Solutin Form pg 146
 Actuator/Valve Specification pg 149
 Terms and Conditions pg 153
 Platinum Distributors pg 155

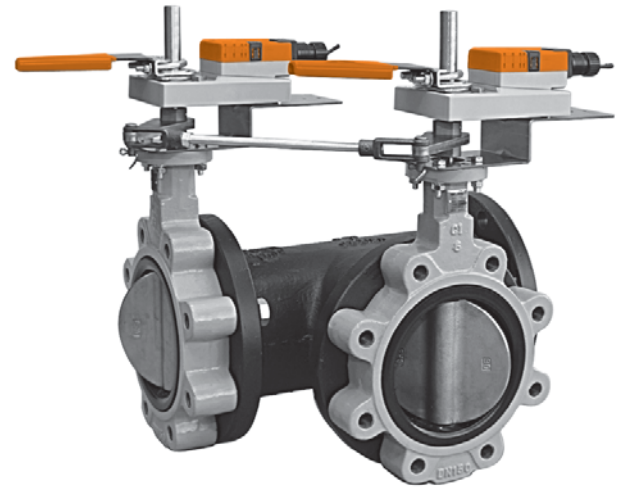

Butterfly Valve:

UFLK Series **Linkage Solution**
 2-way Valves
 3-way Valves

Retrofit Solutions for Virtually any Valve

Manufacturers:

Butterfly: Bray, Centerline, Keystone, Flowseal and more
Control: On/Off, Floating, 2-10VDC Multi-Function Technology®
 Spring Return or Non-Spring Return

SY Series Actuators

Series	Model	Run Time(s) 90°@60Hz	Power Supply	Control			
				Proportional	3 Point	On/Off	Feedback
SY1	SY1-110	12 seconds	120 VAC ±10%, 50/60 Hz		•	•	none, opt 1k
	SY1-24	12 seconds	24 VAC ±10%, 50/60 Hz		•	•	none, opt 1k
	SY1-220	12 seconds	230 VAC ±10%, 50/60 Hz		•	•	none, opt 1k
	SY1-110P	12 seconds	120 VAC ±10%, 50/60 Hz	•			2-10 VDC/4-20 mA
	SY1-24P	12 seconds	24 VAC ±10%, 50/60 Hz	•			2-10 VDC/4-20 mA
	SY1-220P	12 seconds	230 VAC ±10%, 50/60 Hz	•			2-10 VDC/4-20 mA
SY2	SY2-110	15 seconds	120 VAC ±10%, 50/60 Hz		•	•	none, opt 1k
	SY2-24	15 seconds	24 VAC ±10%, 50/60 Hz		•	•	none, opt 1k
	SY2-220	15 seconds	230 VAC ±10%, 50/60 Hz		•	•	none, opt 1k
	SY2-120MFT	15 seconds	120 VAC ±10%, 50/60 Hz	•			2-10 VDC/4-20 mA
	SY2-24MFT	15 seconds	24 VAC ±10%, 50/60 Hz	•			2-10 VDC/4-20 mA
	SY2-230MFT	15 seconds	230 VAC ±10%, 50/60 Hz	•			2-10 VDC/4-20 mA
SY3	SY3-110	22 seconds	120 VAC ±10%, 50/60 Hz		•	•	none, opt 1k
	SY3-24	22 seconds	24 VAC ±10%, 50/60 Hz		•	•	none, opt 1k
	SY3-220	22 seconds	230 VAC ±10%, 50/60 Hz		•	•	none, opt 1k
	SY3-24MFT	22 seconds	120 VAC ±10%, 50/60 Hz	•			2-10 VDC/4-20 mA
	SY3-120MFT	22 seconds	120 VAC ±10%, 50/60 Hz	•			2-10 VDC/4-20 mA
	SY3-230MFT	22 seconds	230 VAC ±10%, 50/60 Hz	•			2-10 VDC/4-20 mA
SY4	SY4-110	16 seconds	120 VAC ±10%, 50/60 Hz		•	•	none, opt 1k
	SY4-24	16 seconds	24 VAC ±10%, 50/60 Hz		•	•	none, opt 1k
	SY4-220	16 seconds	230 VAC ±10%, 50/60 Hz		•	•	none, opt 1k
	SY4-24MFT	16 seconds	120 VAC ±10%, 50/60 Hz	•			2-10 VDC/4-20 mA
	SY4-120MFT	16 seconds	120 VAC ±10%, 50/60 Hz	•			2-10 VDC/4-20 mA
	SY4-230MFT	16 seconds	230 VAC ±10%, 50/60 Hz	•			2-10 VDC/4-20 mA
SY5	SY5-110	22 seconds	120 VAC ±10%, 50/60 Hz		•	•	none, opt 1k
	SY5-24	22 seconds	24 VAC ±10%, 50/60 Hz		•	•	none, opt 1k
	SY5-220	22 seconds	230 VAC ±10%, 50/60 Hz		•	•	none, opt 1k
	SY5-24MFT	22 seconds	120 VAC ±10%, 50/60 Hz	•			2-10 VDC/4-20 mA
	SY5-120MFT	22 seconds	120 VAC ±10%, 50/60 Hz	•			2-10 VDC/4-20 mA
	SY5-230MFT	22 seconds	230 VAC ±10%, 50/60 Hz	•			2-10 VDC/4-20 mA
SY6	SY6-110	28 seconds	120 VAC ±10%, 50/60 Hz		•	•	none, opt 1k
	SY6-220	28 seconds	230 VAC ±10%, 50/60 Hz		•	•	none, opt 1k
	SY6-120MFT	28 seconds	120 VAC ±10%, 50/60 Hz	•			2-10 VDC/4-20 mA
	SY6-230MFT	28 seconds	230 VAC ±10%, 50/60 Hz	•			2-10 VDC/4-20 mA
SY7	SY7-110	46 seconds	120 VAC ±10%, 50/60 Hz		•	•	none, opt 1k
	SY7-220	46 seconds	230 VAC ±10%, 50/60 Hz		•	•	none, opt 1k
	SY7-120MFT	46 seconds	120 VAC ±10%, 50/60 Hz	•			2-10 VDC/4-20 mA
	SY7-230MFT	46 seconds	230 VAC ±10%, 50/60 Hz	•			2-10 VDC/4-20 mA
SY8	SY8-110	46 seconds	120 VAC ±10%, 50/60 Hz		•	•	none, opt 1k
	SY8-220	46 seconds	230 VAC ±10%, 50/60 Hz		•	•	none, opt 1k
	SY8-120MFT	46 seconds	120 VAC ±10%, 50/60 Hz	•			2-10 VDC/4-20 mA
	SY8-230MFT	46 seconds	230 VAC ±10%, 50/60 Hz	•			2-10 VDC/4-20 mA

Proportional actuators will accept 0-10 VDC, 2-10 VDC, or 4-20 mA control signals as standard.
 All SY actuators are non-spring return, but can be used with NSV-SY back up systems for fail safe applications.
 These products carry a two year warranty when sold as part of an assembly or with a UFLK retrofit kit.

L30043 - 07/09 - SUBJECT TO CHANGE. © BELIMO AIRCONTROLS (USA), INC.

SY Series Actuators

Series	Model	Run Time(s) 90°@60Hz	Power Supply	Control			
				Proportional	3 Point	On/Off	Feedback
SY9	SY9-110	58 seconds	120 VAC ±10%, 50/60 Hz		•	•	none, opt 1k
	SY9-220	58 seconds	230 VAC ±10%, 50/60 Hz		•	•	none, opt 1k
	SY9-120MFT	58 seconds	120 VAC ±10%, 50/60 Hz	•			2-10 VDC/4-20 mA
	SY9-230MFT	58 seconds	230 VAC ±10%, 50/60 Hz	•			2-10 VDC/4-20 mA
SY10	SY10-110	58 seconds	120 VAC ±10%, 50/60 Hz		•	•	none, opt 1k
	SY10-220	58 seconds	230 VAC ±10%, 50/60 Hz		•	•	none, opt 1k
	SY10-120MFT	58 seconds	120 VAC ±10%, 50/60 Hz	•			2-10 VDC/4-20 mA
	SY10-230MFT	58 seconds	230 VAC ±10%, 50/60 Hz	•			2-10 VDC/4-20 mA
SY11	SY11-110	58 seconds	120 VAC ±10%, 50/60 Hz		•	•	none, opt 1k
	SY11-220	58 seconds	230 VAC ±10%, 50/60 Hz		•	•	none, opt 1k
	SY11-120MFT	58 seconds	120 VAC ±10%, 50/60 Hz	•			2-10 VDC/4-20 mA
	SY11-230MFT	58 seconds	230 VAC ±10%, 50/60 Hz	•			2-10 VDC/4-20 mA
SY12	SY12-110	58 seconds	120 VAC ±10%, 50/60 Hz		•	•	none, opt 1k
	SY12-220	58 seconds	230 VAC ±10%, 50/60 Hz		•	•	none, opt 1k
	SY12-120MFT	58 seconds	120 VAC ±10%, 50/60 Hz	•			2-10 VDC/4-20 mA
	SY12-230MFT	58 seconds	230 VAC ±10%, 50/60 Hz	•			2-10 VDC/4-20 mA

Proportional actuators will accept 0-10 VDC, 2-10 VDC, or 4-20 mA control signals as standard.

All SY actuators are non-spring return, but can be used with NSV-SY back up systems for fail safe applications.

These products carry a two year warranty when sold as part of an assembly or with a UFLK retrofit kit.

SY Multi-Function Technology

Description	P-CODE	Control Input	Built-in Feedback	Loss of Signal	Running Time
MFT	ACE	2...10V	2...10V	stop	actuator(s) constant
MFT	ACF	0.5...10V	0.5...10V	stop	actuator(s) constant
MFT	ACG	4...20mA	4...20mA	stop	actuator(s) constant
MFT	ACH	4...20mA	2...10V	stop	actuator(s) constant
MFT	ACJ	2...10V	2...10V	open	actuator(s) constant
MFT	ACK	0.5...10V	0.5...10V	open	actuator(s) constant
MFT	ACL	4...20mA	4...20mA	open	actuator(s) constant
MFT	ACM	4...20mA	2...10V	open	actuator(s) constant
MFT	ACN	2...10V	2...10V	close	actuator(s) constant
MFT	ACP	0.5...10V	0.5...10V	close	actuator(s) constant
MFT	ACR	4...20mA	4...20mA	close	actuator(s) constant
MFT	ACS	4...20mA	2...10V	close	actuator(s) constant

Rotary Actuators

Series	Model	Spring Return	Control Input	Feedback Position	Power Supply
AF Series*	AF24 US	•	24 VAC/DC		24 VAC/DC
	AF24-MFT US	•	Variable with MFT (VDC, PWM, Floating Pt., On/Off)	variable VDC	24 VAC/DC
AM Series*	AMB24-3X1		24 VAC/DC		24 VAC/DC
	AMB24-MFTX1		Variable with MFT (VDC, PWM, Floating Pt., On/Off)	variable VDC	24 VAC/DC
GM Series*	GMB24-3X1		24 VAC/DC		24 VAC/DC
	GMB24-MFTX1		Variable with MFT (VDC, PWM, Floating Pt., On/Off)	variable VDC	24 VAC/DC

*Please consult the Product Guide and Price List for a complete selection of Spring Return and Non-Spring Return Actuators of the listed series.

Standard run times should be considered in the selection.

Multi-Function Technology

ROTARY ACTUATOR CODES	Programming Codes		Control Input	Running Time	Built-in Feedback
		P-10001	A01	2-10 VDC	150 seconds
	P-10002	A02	0-10 VDC	150 seconds	0-10 VDC
	P-10028	A28	0-10 VDC	150 seconds	0-10 VDC
	P-10063	A63	0.5-4.5 VDC	150 seconds	0.5-4.5 VDC
	P-10064	A64	5.5-10 VDC	150 seconds	5.5-10 VDC
	P-20002	W02	0.02-5.00 seconds PWM	150 seconds	2-10 VDC
	P-20003	W03	0.10-25.5 seconds PWM	150 seconds	2-10 VDC
	P-30001	F01	Floating Pt.	150 seconds	2-10 VDC
	P-40002	J02	On/Off	150 seconds	2-10 VDC

2-way Valves

		Spring Return				Non-Spring Return			
Actuator		AF	2*AF	2*AF	2*AF	AM	GM	GM	2*GM
Linkage		UFLK3930	UFLK3936	UFLK3938	UFLK3940	UFLK3900	UFLK3904	UFLK3905	UFLK3910
Size	Close-off psi								
2"	50	UFLK3930				UFLK3900			
2½"	50	UFLK3930				UFLK3900			
3"	50		UFLK3936			UFLK3900			
4"	50			UFLK3938			UFLK3904		
5"	50				UFLK3940			UFLK3905	
6"	50								UFLK3910

		SY						
Actuator		SY1	SY2	SY2	SY2	SY3	SY3	SY4
Linkage		UFLK3912	UFLK3918	UFLK3920	UFLK3922	UFLK3924	UFLK3926	UFLK3928
Size	Close-off psi							
2"	50	UFLK3912	UFLK3918					
2½"	50	UFLK3912	UFLK3918					
3"	50	UFLK3912	UFLK3918					
4"	50			UFLK3920				
5"	50				UFLK3922			
6"	50				UFLK3922			
8"	50					UFLK3924		
10"	50						UFLK3926	
12"	50							UFLK3928

3-way Valves

		Spring Return			Non-Spring Return		
Actuator		AF	2*AF	GM	2*GM	2*GM	
Linkage		UFLK6950	UFLK6952	UFLK6900	UFLK6904	UFLK6906	
Size	Close-off psi						
2"	50	UFLK6950		UFLK6900			
2½"	50		UFLK6952	UFLK6900			
3"	50		UFLK6952	UFLK6900			
4"	50				UFLK6904		
5"	50					UFLK6906	
6"	50					UFLK6906	

		SY						
Actuator		SY1	SY2	SY2	SY2	SY3	SY4	SY4
Linkage		UFLK6908	UFLK6910	UFLK6912	UFLK6914	UFLK6919	UFLK6920	UFLK6922
Size	Close-off psi							
2"	50	UFLK6908	UFLK6910					
2½"	50	UFLK6908	UFLK6910					
3"	50		UFLK6910					
4"	50			UFLK6912				
5"	50				UFLK6914			
6"	50				UFLK6914			
8"	50					UFLK6919		
10"	50						UFLK6920	
12"	50							UFLK6922

L30043 - 07/09 - SUBJECT TO CHANGE. © BELIMO AIRCONTROLS (USA), INC.

2-way Valves

		Spring Return		Non-Spring Return			SY			
Actuator		AF	2*AF	AM	GM	2*GM	SY2	SY2	SY2	SY3
Linkage		UFLK3930	UFLK3936	UFLK3900	UFLK3900	UFLK3908	UFLK3918	UFLK3920	UFLK3922	UFLK3922
Size	Close-off psi									
2"	200	UFLK3930		UFLK3900			UFLK3918			
2½"	200		UFLK3936	UFLK3900			UFLK3918			
3"	200		UFLK3936		UFLK3900		UFLK3918			
4"	200					UFLK3908		UFLK3920		
5"	200								UFLK3922	
6"	200									UFLK3922

		SY						
Actuator		SY4	SY4	SY4	SY5	SY6	SY8	SY11
Linkage		UFLK3968	UFLK3970	UFLK3928	UFLK3928	UFLK3976	UFLK3978	UFLK3982
Size	Close-off psi							
8"	200	UFLK3968						
10"	200		UFLK3970					
12"	200			UFLK3928				
14"	150				UFLK3928			
16"	150					UFLK3976		
18"	150						UFLK3978	
20"	150							
24"	150							UFLK3982

3-way Valves

		Spring Return		Non-Spring Return		SY			
Actuator		AF	2*AF	AM	2*GM	SY2	SY2	SY3	SY4
Linkage		UFLK6950	UFLK6952	UFLK6900	UFLK6902	UFLK6910	UFLK6912	UFLK6914	UFLK6920
Size	Close-off psi								
2"	200	UFLK6950		UFLK6900		UFLK6910			
2½"	200		UFLK6952		UFLK6902	UFLK6910			
3"	200				UFLK6902	UFLK6910			
4"	200						UFLK6912		
5"	200							UFLK6914	
6"	200							UFLK6914	
8"	200								UFLK6920

		SY						
Actuator		SY4	SY5	SY6	SY7	SY8	SY9	SY12
Linkage		UFLK6920	UFLK6922	UFLK7018	UFLK7020	UFLK7022	UFLK7024	UFLK7026
Size	Close-off psi							
10"	200	UFLK6920						
12"	200		UFLK6922					
14"	150			UFLK7018				
16"	150				UFLK7020			
18"	150					UFLK7022		
20"	150						UFLK7024	
24"	150							UFLK7026

L-30043 - 07/09 - SUBJECT TO CHANGE. © BELIMO AIRCONTROLS (USA), INC.

Industrial Electric 2-way

Generic – Must complete BFV Retrofit Form

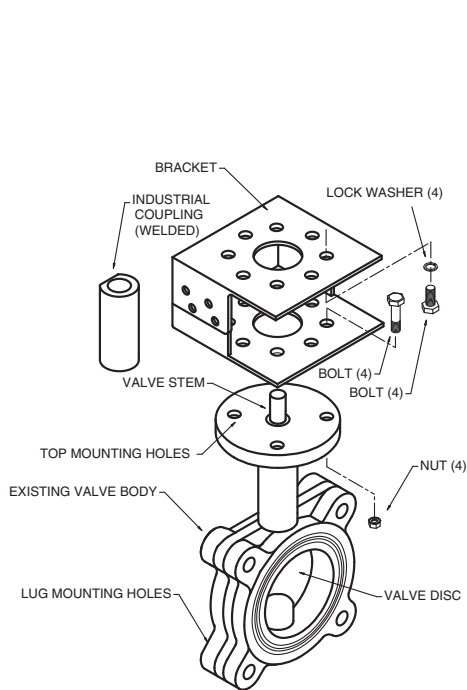

UFSP0020
UFSP0022

SY1 - SY8
SY9 - SY12

Industrial Electric 3-way

Generic – Must complete BFV Retrofit Form

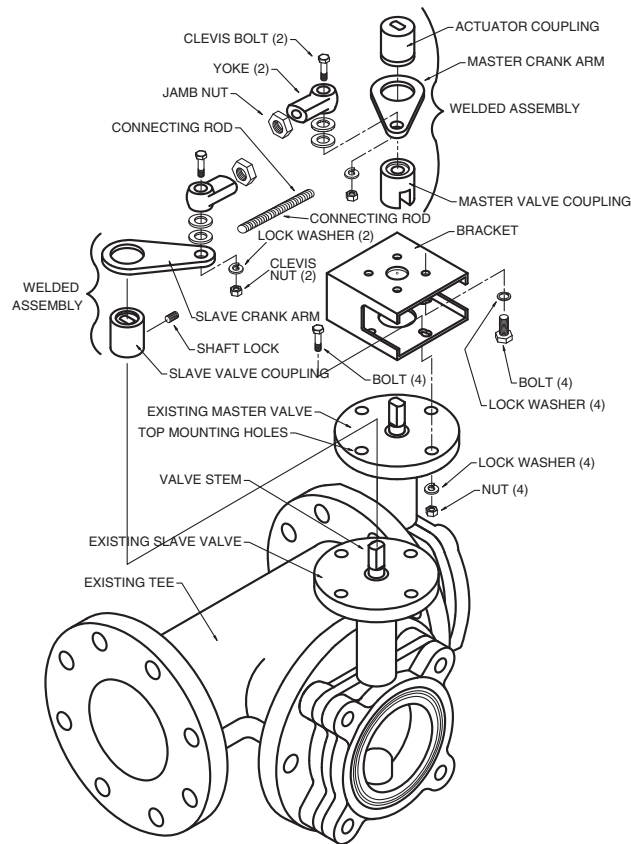

UFSP0024
UFSP0026

SY1 - SY8
SY9 - SY12

NOTE: 3-way bracket configuration shown is only one of many possible arrangements.

Assembly Procedure for SY...Retrofit Solution

Retrofit Requirement: The initial step is to determine if your application can accept a retrofit solution. As shown below (Fig. 1), the valve stem must not be located below the horizontal plane. If this condition exists, the SY actuator could not be used in this situation. A Belimo technical support person is available to help determine what solution best fits your application. A typical solution is shown in Fig. 2.

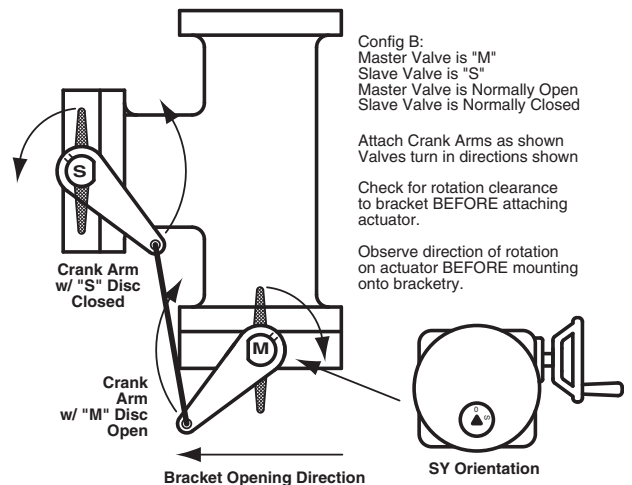
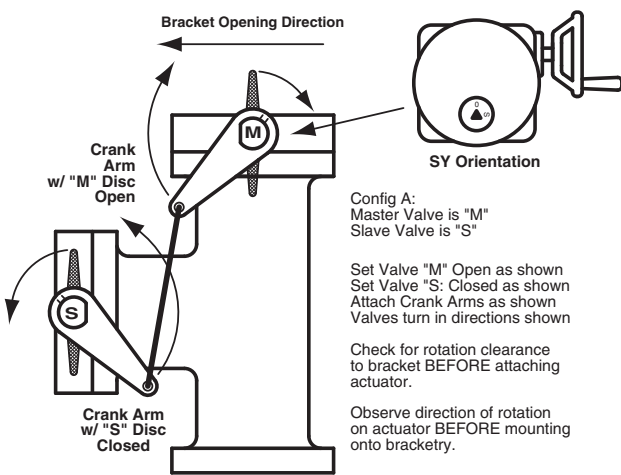
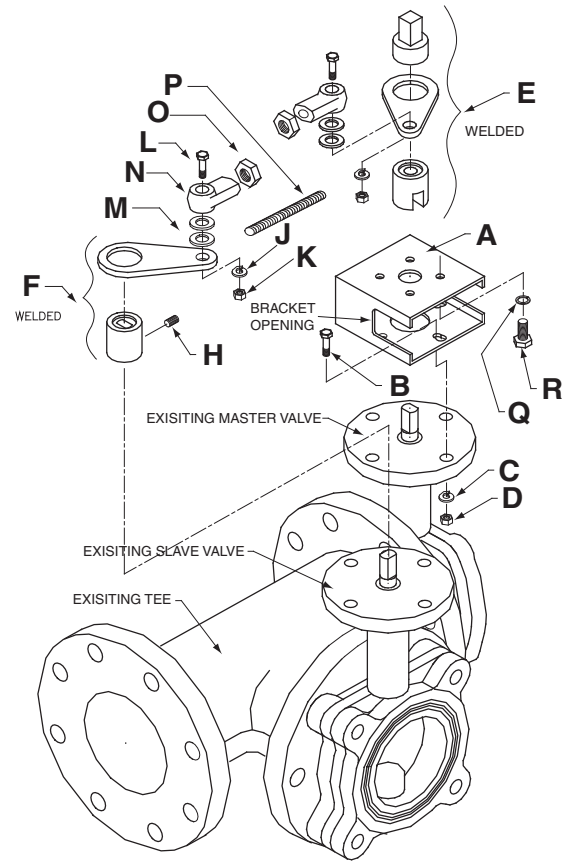
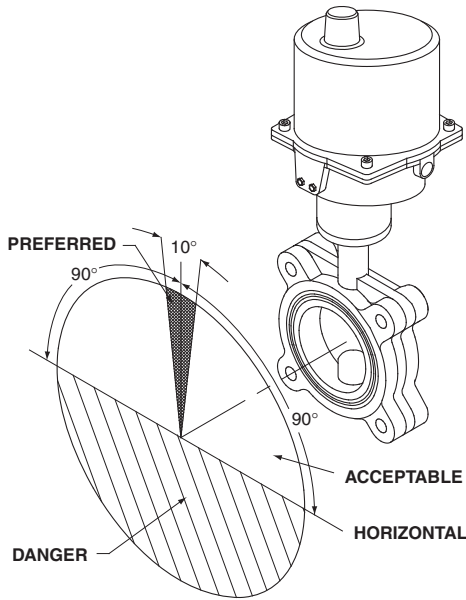

Depending on the orientation of the tee assembly, if the valves are mounted on the TOP and BRANCH positions (tee mounted vertically), or on the LEFT and BRANCH positions (tee mounted horizontally) you will refer to configuration direction set **A**.

If the valves are mounted on the BOTTOM and BRANCH positions (tee mounted vertically), or on the RIGHT and BRANCH positions (tee mounted horizontally) you will refer to configuration direction set **B**.

SY... Series Butterfly Valve Retrofit Solution

Retrofitting 3-way Valves with Belimo SY Non-Spring Return Actuator

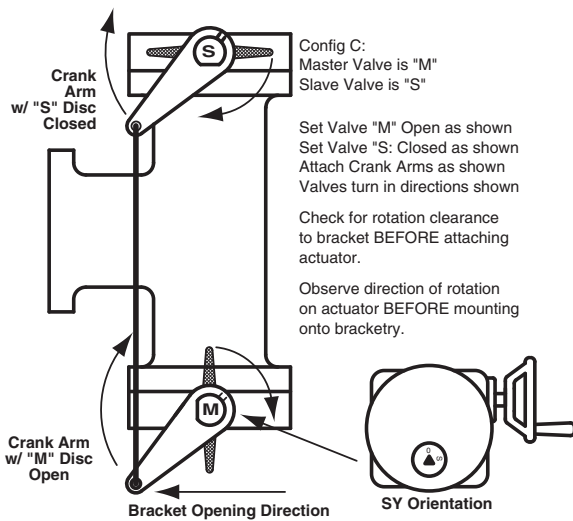

If the valves are mounted on the TOP and BOTTOM positions (tee mounted vertically), or on the LEFT and RIGHT positions (tee mounted horizontally) you will refer to configuration direction set C.

Assembly Procedure (Mechanical)

Note: For purposes of clarity, this procedure utilizes configuration type B.

During the assembly procedure, CLOSED and OPEN means 0 degrees and 90 degrees respectively. Failure to position the discs into their proper quadrants will result in improper operation and performance of the retrofit kit. Most manufacturers mark the TOP of the valve stem with a slot or other mark which indicates the disc angle. **Note:** regardless of configuration code, the Master valve should always be OPEN and the Slave valve should always be CLOSED before starting the assembly process.

Note: Steps 3 thru 6 may be combined into a single step if the retrofit kit is received with actuator, bracket and crank arm already assembled. The actuator will be in the OPEN position for assembly.

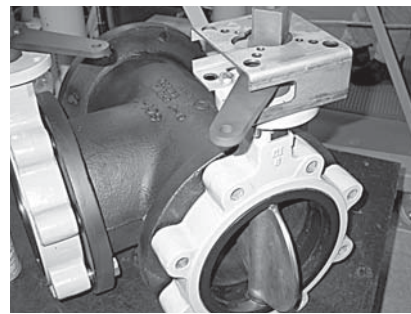

Step 3) Install the MASTER valve crank arm onto the MASTER valve in the correct orientation, as shown. Install the SLAVE valve crank arm onto the SLAVE valve in the correct orientation, as shown.

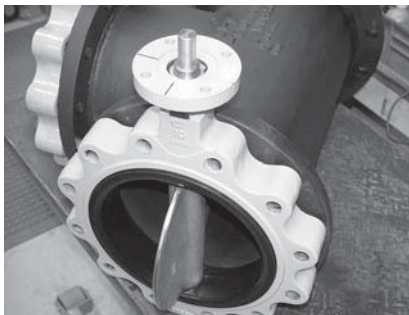

Step 1) Both valves must be stripped down to their basic form. Remove all other linkage components before starting the assembly sequence below. The linkage components have been designed to attach to the valves in their basic form state rather than to any existing hardware.

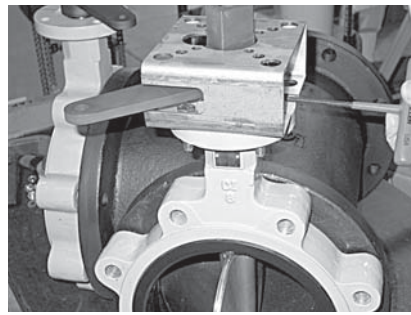

Step 4) Tighten the MASTER and SLAVE crank arm assemblies using the appropriate hex key wrench. Make sure the drive couplings are fully seated onto the valve stems BEFORE tightening the set screws.



Step 2) Referring to the three configuration types on pages 136 and 137, position the master and slave valve discs as instructed. For example, if you have a Configuration Type B tee assembly, you will OPEN the Master valve (M) and CLOSE the Slave valve (S).



Step 5) Shown here is the SLAVE crank arm assembly being secured to the valve stem. Notice the markings on the valve top works indicating OPEN and CLOSED positions of the stem for later reference.

L30043 - 07/09 - SUBJECT TO CHANGE. © BELIMO AIRCONTROLS (USA), INC.

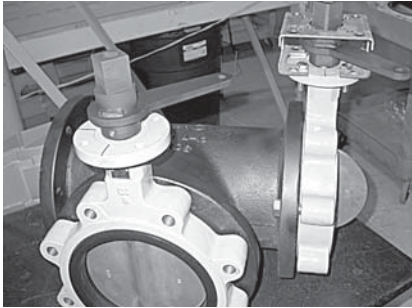

Step 6) There are no other possible orientations of this bracket. The Master crank arm will rotate 90 degrees clockwise, and there are reliefs in the sides of the bracket to accommodate this angular rotation.



Step 10) Although the SY actuator ships from the factory IN the OPEN position, make sure the actuator IS in the OPEN position before attaching to the valve/coupling assembly. The SY actuator turns counter clockwise (CCW) to the OPEN

position when viewed from ABOVE the actuator.

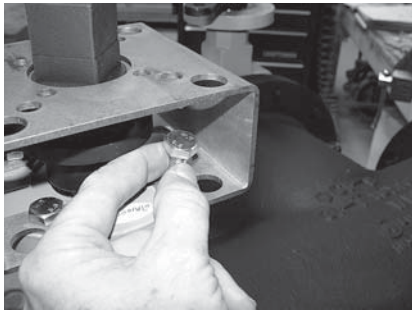

Step 7) Insert the four bolts the mount the bracket to the valve mounting flange. Attach the lock washers and nuts, but do NOT tighten at this time.

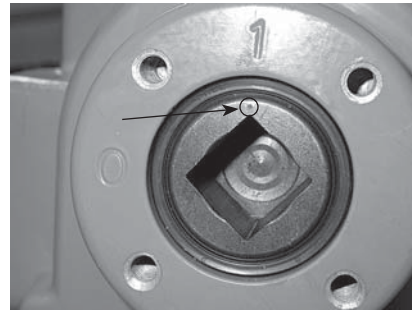

Step 11) Verify that the SY actuator is in the OPEN position also by looking at the bottom of the actuator. There is a dimple mark punched in the output shaft which will align with the "1" mark when the actuator is in the OPEN position.

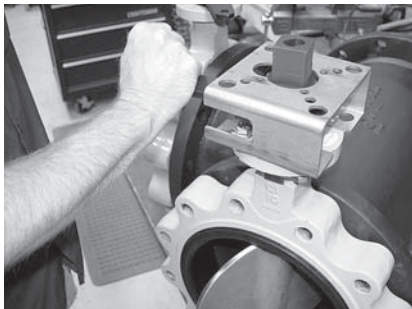

Step 8) To facilitate the insertion of the mounting bolts, it may be necessary to move the valve disc, and therefore the crank arm, to gain access to the mounting holes.

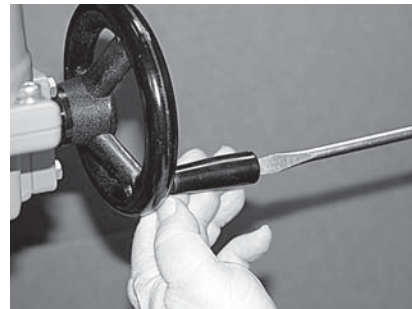

Step 12) Attach the hand knob to the hand wheel as shown below (if not already completed).



Step 9) Remove the SY actuator from its protective cartons.

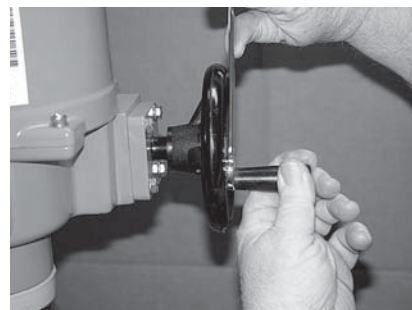

Step 13) Tighten the jam nut to prevent the hand knob from coming loose.

SY... Series Butterfly Valve Retrofit Solution

Retrofitting 3-way Valves with Belimo SY Non-Spring Return Actuator



Step 14) Stand with the opening in the actuator bracket facing towards your LEFT. Hold the SY actuator with the handwheel on the RIGHT, and the EMT connectors to your LEFT. Align the square drive or keyway in the SY

actuator with the square drive or keys in the coupling (C). The SY actuator will slide completely over the drive square and will rest ON the mounting bracket (A).

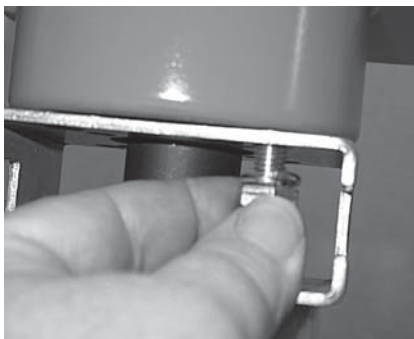

Step 15) Insert the four hex bolts (G) and lock washers (F) through the bracket and into the bottom of the SY actuator as shown. Do NOT tighten until all four sets have been installed. Slight twisting of the entire SY actuator will facilitate alignment of the bolts.



Step 16) After all four bolts have been inserted, tighten accordingly.

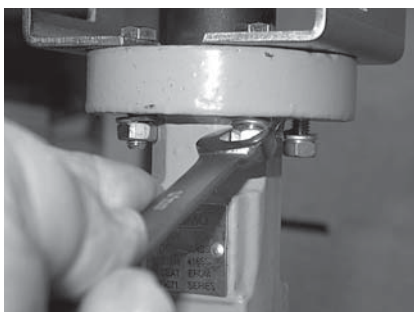

Step 17) Now tighten the four bracket bolts (B, C, D) assembled in step 6 above.



Step 18) When mechanical assembly is complete, the SY actuator and MASTER valve should be oriented as shown below. The actuator is in the OPEN position, and the valve disc is fully OPEN, and all bolts are tight.

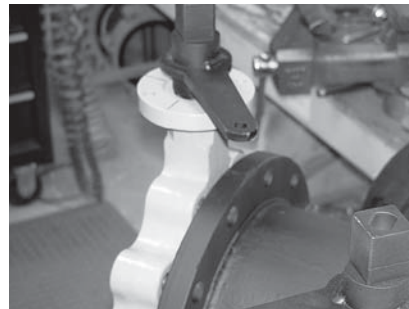

Step 19) The SLAVE valve is fully CLOSED with the crank arm oriented as shown.

Note:

The assembly now must be tested electrically **before** mechanical connection is made between the MASTER and SLAVE valve crank arms. Continue with Electrical Assembly on pages 140 for On/Off models or page 141 for proportional models.

Application Note:

The hand wheel on the SY actuator is engaged at all times but does not rotate when the actuator is running. It is possible at anytime to turn the hand wheel by simply rotating it CW or CCW. The hand wheel does NOT need to be pulled or pushed into the actuator to make it operational. However, it should be noted that if a control signal and power is present at the actuator when the hand wheel is turned, the actuator will return to its controlled position. If it is desired to have the actuator maintain its position after turning the hand wheel, it will be necessary to remove power from the actuator, either at the source or by use of an optional SY-HOA local switch.

Assembly Procedure (Mechanical)

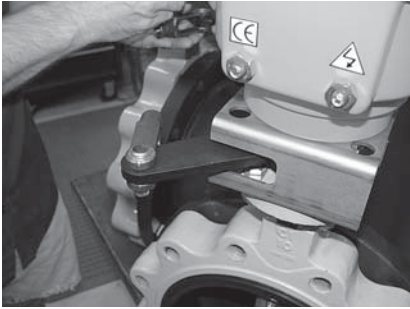

Step 20) With the MASTER valve in its fully OPEN position and the SLAVE valve in its fully CLOSED position, assemble the yoke and clevis pins onto the crank arms, pointing towards each other as shown.

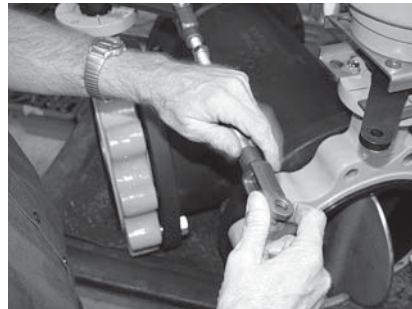

Step 23) Remove the MASTER valve yoke end and thread it onto the connecting rod. Adjust the distance between the yoke centers to match the hole in the MASTER valve crank arm.

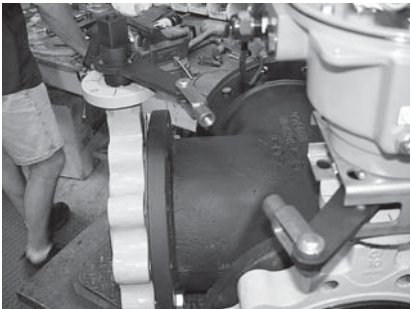

Step 24) Insert the clevis pin into the master crank arm.



Step 25) Using the correct control signal (On/Off or Proportional) drive the MASTER valve 25% CLOSED, then drive the MASTER valve fully OPEN. The SLAVE valve should now be fully CLOSED. The SLAVE valve should now be fully CLOSED. If the

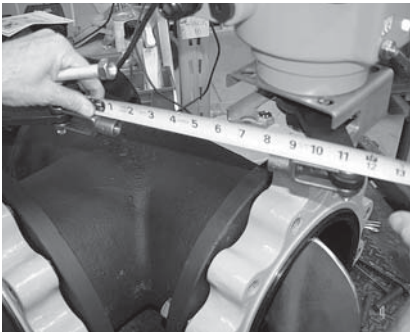

Step 21) Measure the distance between the inboard end of the yokes to determine the proper length of the connecting rod. It is important to make sure the MASTER and SLAVE valves are in their proper positions (OPEN and CLOSED, respectively) before

taking this measurement. Otherwise, the connecting rod could be too short for proper calibration of the SLAVE valve.

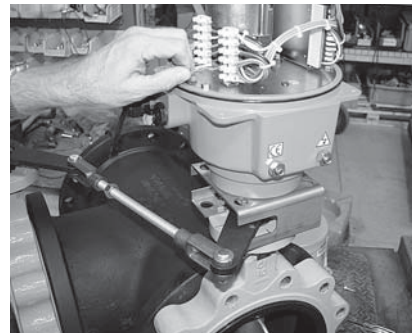

SLAVE valve needs to be adjusted, it is accomplished by turning one of the yoke ends in (to shorten) or out (to lengthen) and rechecking the rotation angle using terminals #3 & #4 on the SY actuator. Always be sure to let the electrical travel cams stop the SY actuator before making any adjustments in the yoke ends of the connecting rod.

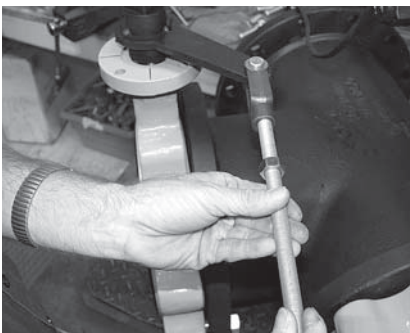

Step 22) After the connecting rod is cut to the correct length, screw it into SLAVE valve yoke end until the threads pass through the yoke and just start to protrude into the inboard end of the yoke. The rod lock nut should be closest to the SLAVE valve yoke end.

SY... Series Butterfly Valve Retrofit Solution

Retrofitting 3-way Valves with Belimo SY On/Off Non-Spring Return Actuator



Assembly Procedure (Mechanical), *continued*



Step 26) Once the SLAVE valve has been determined to be in the correct position, lock the jam nut against one of the yoke ends to prevent any changes in the adjustments just completed.

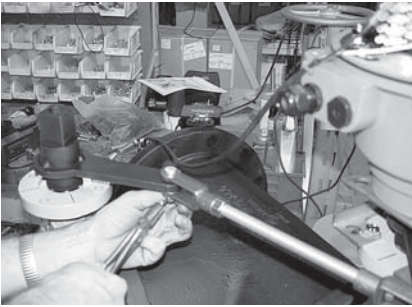

Step 27) Insert two cotter keys into the two clevis pins.

Step 28) Replace the cover on the SY actuator and secure the four cover screws. One final check to make sure all bolts, screws, nuts & setscrews are tight.

Step 29) The mechanical and electrical installation of your retrofit system is now complete.

END PROCEDURE

Assembly Procedure (Electrical), On/Off Models

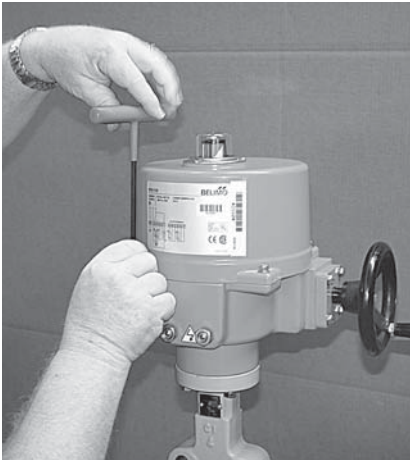

Step 1) Remove the four hex bolts securing the cover to the base casting.

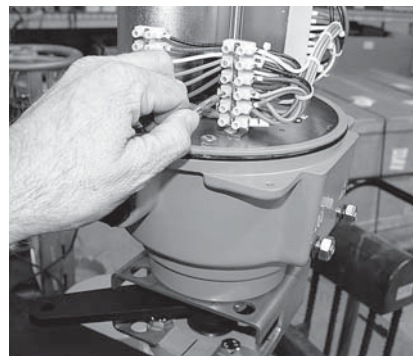

Step 6) Apply proper voltage to terminals #1 (Neutral) & #7 (Hot). Apply proper actuator voltage to terminals #1 (Neutral) & #4 (Hot) to drive the actuator CLOSED until the end-of-travel cam STOPS the actuator movement. (Note that there is no terminal #2).

Step 7) Visually check the position of the valve to make sure it reaches its full CLOSED position.

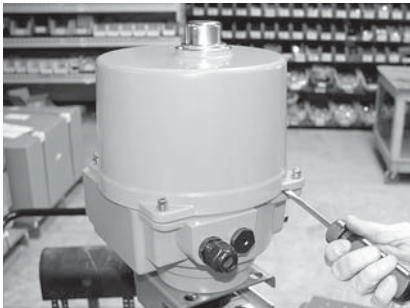

Step 2) Remove cover from the SY actuator. A flat blade screwdriver inserted carefully into the provided slot (as shown) will facilitate removal of the cover.

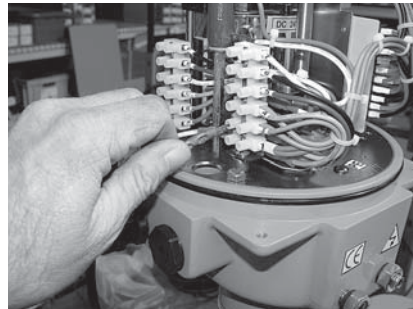

Step 8) Apply proper actuator voltage to terminals #1 (Neutral) & #3 (Hot) to drive the actuator OPEN until the end-of-travel cam STOPS the actuator movement.

Step 9) Visually check the position of the valve disc to make sure it reaches its full OPEN position.

Step 10) If the MASTER valve functions properly, mechanical assembly and electrical checkout are complete for the MASTER valve.

Step 3) Conduit entries into the SY actuator must be selected for their operating location (indoors protected, indoors wash down, outdoors, etc). Be sure to follow standard NEC guidelines when selecting conduit and connector types.

Step 4) Follow the wire sizing chart in the IOM guide (Belimo p/n 70103-00001D page 17) to make sure you use the correctly size wire when connecting the SY to your power source. Failure to follow the recommendations in the table could cause actuator failure or nuisance tripping.

Step 5) Follow the wiring diagrams in the IOM guide pages 18 (single) & 23 (multiple) for proper power and control wiring to the SY actuator. Make note of the following:

- a. Do NOT connect multiple actuators in parallel without isolation relays.
- b. Be sure "Hot" is connected to terminal #7 to enable the heater circuit, and "Neutral" is connected to terminal #1.

WARNING

FACTORY NOTE:

The SY... actuator has been calibrated at the factory before shipping to you for use in this retrofit kit. 99% of the time the SY actuator calibration will suffice for your application. Before making ANY adjustments to the actuator, improper calibration may VOID your warranty. If you have any questions, please contact a Belimo Technical Support representative at 800-543-9038 for assistance.

SY...P Series Butterfly Valve Retrofit Solution

Retrofitting 3-way Valves with Belimo SY Proportional Non-Spring Return Actuator



Assembly Procedure (Electrical), Proportional Models



Step 1) Remove the four hex bolts securing the cover to the base casting.



Step 2) Remove cover from the SY actuator. A flat blade screwdriver inserted carefully into the provided slot (as shown) will facilitate removal of the cover.

Step 3) Conduit entries into the SY actuator must be selected for their operating location (indoors protected, indoors wash down, outdoors, etc). Be sure to follow standard NEC guidelines when selecting conduit and connector types.

Step 4) Follow the wire sizing chart in the IOM guide (Belimo p/n 70103-00001D page 17) to make sure you use the correct size wire when connecting the SY to your power source. Failure to follow the recommendations in the table could cause actuator failure or nuisance tripping.

Step 5) Follow the wiring diagrams in the IOM guide pages 14 through 37 for proper power and control wiring to the SY actuator.

Note: All SY1-P and SY2..12-SR/MFT actuators are factory pre-set with the proper customer requested control programming.

Step 6) Connect the proper electrical power and control wiring per the wiring diagrams located in the Installation Operation Manual Guide pages 14-37.

Step 7) Check the operation of the actuator by commanding the control system to generate control signals matching the needs of the job to run the valve from fully CLOSED to fully OPEN, as well as a MID-POINT position. The indicator on the top of the SY actuator will be an indicator as to the position of the actuator, and therefore, the valve position.

When operating the MASTER valve between fully OPEN and CLOSED, check the clearance between the crank arm and the actuator bracket. The crank arm should NEVER come into contact with the actuator mounting bracket. If it does, immediately remove power from the actuator and call Belimo technical support for recalibration instructions.

Step 8) If the valve functions properly, mechanical assembly and electrical checkout are complete.



WARNING

FACTORY NOTE:

The SY actuators have been calibrated at the factory before shipping to you for use in this retrofit kit. 99% of the time the SY actuator calibration will suffice for your application. Before making ANY adjustments to the actuator, improper calibration may VOID your warranty. If you have any questions, please contact a Belimo Technical Support representative at 800-543-9038 for assistance.

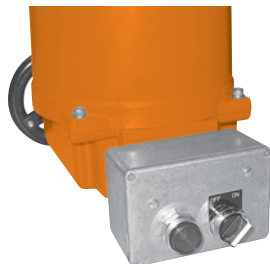
**SY-HOA...
Local Electric Disconnect**

NSV-SY... Battery Backup System

SY... Handwheel

SY-HOA-110	Local Electric Disconnect SY2-SY12 110V 2 Position
SY-HOA-110P	Local Electric Disconnect SY2-SY12 110V Proportional
SY-HOA-24	Local Electric Disconnect SY2-SY12 24V 2 Position
SY-HOA-24P	Local Electric Disconnect SY2-SY12 24V Proportional

SY-1000-FB01	1000 Ω Feedback Potentiometer SY2-12 2 Position
SY-1000-FB02	1000 Ω Feedback Potentiometer SY2-12 Proportional

NSV-SY-01	Battery Backup System for SY1-SY6 2 Position - 110 VAC
NSV-SY-02	Battery Backup System for SY1-SY6 Proportional - 110 VAC
NSV-SY-03	Battery Backup System for SY7 2 Position - 110 VAC
NSV-SY-04	Battery Backup System for SY7 Proportional - 110 VAC
NSV-SY-05	Battery Backup System for SY8-SY12 2 Position - 110 VAC
NSV-SY-06	Battery Backup System for SY8-SY12 Proportional - 110 VAC
NSV-SY-11	Battery Backup System for SY1-SY5 2 Position - 24 VAC
NSV-SY-12	Battery Backup System for SY1-SY5 Proportional - 24 VAC
NSV-SY-21	Battery Backup System for SY1-SY6 2 Position - 220 VAC
NSV-SY-22	Battery Backup System for SY1-SY6 Proportional - 220 VAC
NSV-SY-23	Battery Backup System for SY7-SY9 2 Position - 220 VAC
NSV-SY-24	Battery Backup System for SY7-SY9 Proportional - 220 VAC
NSV-SY-25	Battery Backup System for SY10-SY12 2 Position - 220 VAC
NSV-SY-26	Battery Backup System for SY10-SY12 Proportional - 220 VAC

ZG-SY23	SY2-3 Handwheel (replacement only)
ZG-SY46	SY4-6 Handwheel (replacement only)
ZG-SY78	SY7-8 Handwheel (replacement only)
ZG-SY912	SY9-12 Handwheel (replacement only)

L-30043 - 07/09 - SUBJECT TO CHANGE. © BELIMO AIRCONTROLS (USA), INC.