TABLE OF CONTENTS

Overview	2
SE8600 Rooftop Unit and Indoor Air Quality Controllers	3
SE8600UxBxx 2 Heating / 2 Cooling for Rooftop Unit and Indoor Air Quality	4
SE8600UxBxx 2 Cooling / Modulating Heat for Rooftop Unit and Indoor Air Quality	6
Fresh Air Damper Control Sequences	8
Economizer Control Only	8
Economizer Control Mode and Fresh Air Measurement Station	9
Economize Control Mode and CO2 Level Control	10
Economizer Control Mode, CO2 Level Control and Fresh Air Measurement Station	11
Appendix A - Passive infra-red (PIR) motion detector cover specifications	12
Appendix B - Optional Network Set-Up	13
Appendix C - Controllers' Occupancy Sequence of Operation Schematic	13
Appendix D - Wireless door & window switch	14
Appendix E - Terminal Correspondance	15

OVERVIEW

SE8600

The SE8600 Rooftop and Indoor Air Quality Controller is a new, cost-effective solution for upgrading rooftop unit thermostats. This solution allows existing wiring between the rooftop unit and the temperature controller to be re-used, reducing overall costs and installation time. The SE8600 can also add new features like CO₂ and fresh air monitoring to the existing functions of a rooftop unit.

The SE8600 Rooftop and Indoor Air Quality Controller can be configured to handle a broad variety of applications covering all the standard implementations necessary for rooftop HVAC systems.

In addition to controlling heating, cooling and air quality, depending on the model and accessories, the SE8600 can handle wireless networking and switches, Passive Infrared (PIR) occupancy detection using either onboard or remote sensors, and can have custom programs implemented to fulfill specific user requirements.

The applications described here cover all these features, and in combination with the SE8600's advanced scheduling and occupancy controls can provide the functionality for any required rooftop HVAC implementation.

SE8600 ROOFTOP UNIT AND INDOOR AIR QUALITY ROOM CONTROLLERS

Commercial and Hospitality Interface (Local Override and Degrees C/F Selection)

	Part Number	Description	PIR Sensor	Communication
	SE8600U0BXX	RTU/HPU terminal equipment controller	No	BACnet® / Modbus®
SE8600U5BXX	RTU/HPU terminal equipment controller	Yes	BACnet® / Modbus®	

ZigBee Pro Module for SE(R)8000 Series

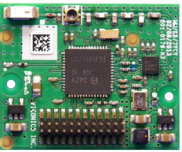
	Part Number	Description
	VCM8000V5045P	Optional ZigBee® Pro module for SE8000 Series room controllers.

Wireless Accessories for SE8600 Series

	Part Number	Description
	SED-CMS-P-5045	Wireless ceiling mounted motion sensor
	SED-WDS-P-5045	Wireless window and door switch
	SED-WMS-P-5045	Wireless wall mounted motion sensor

SE8600UXBXX 2 HEATING / 2 COOLING FOR ROOFTOP UNIT AND INDOOR AIR QUALITY

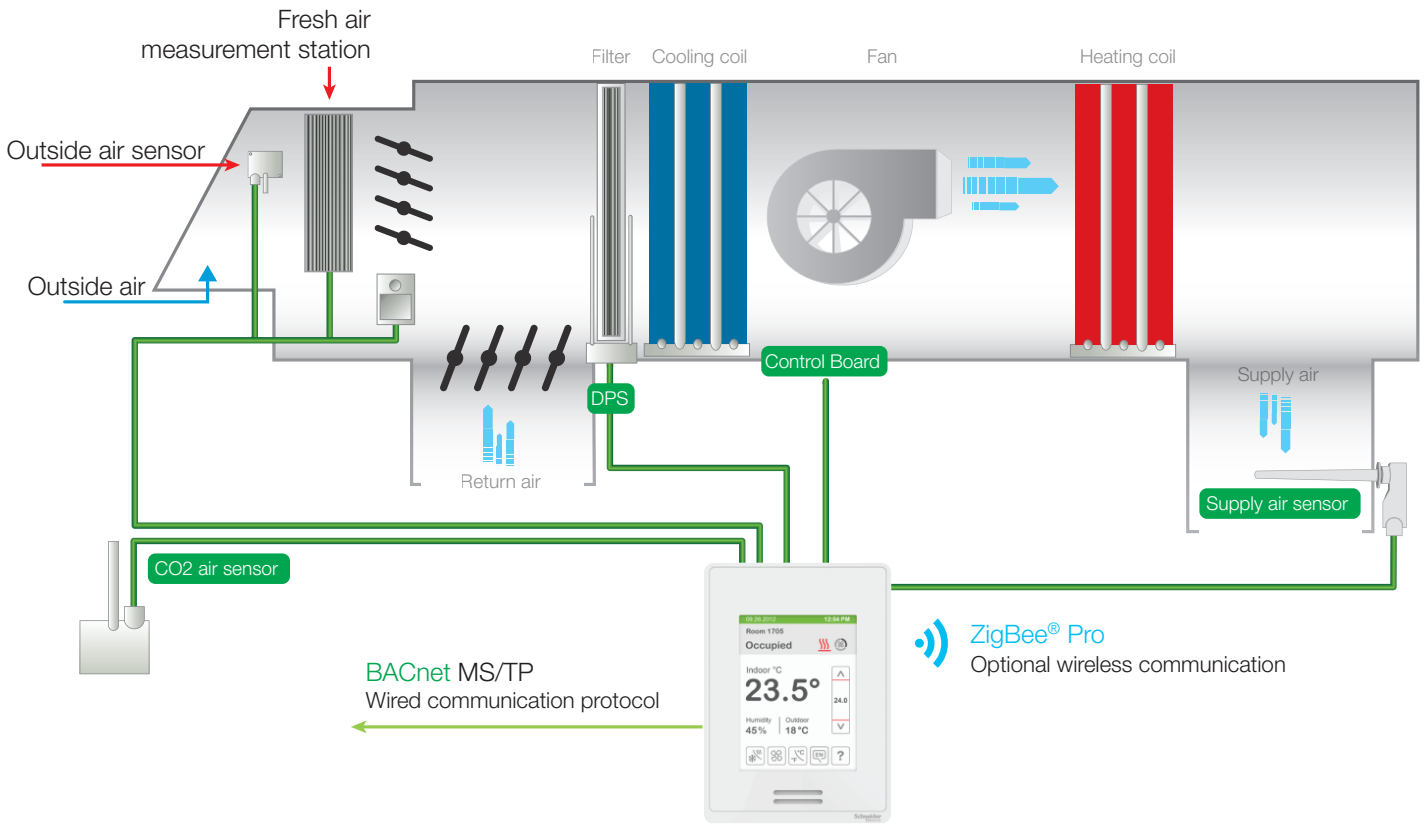

Configuration Parameter Name	Configuration Settings
UI17	Filter
UI19	CO2
Econo. Config	On
FA Range	Set Max CFM, cannot be zero
Min fresh air	Set Min CFM, cannot be zero
Max fresh air	Set Max CFM, cannot be zero
Min CO2	Set Min CO2, cannot be zero
Max CO2	Set Max CO2, cannot be zero

Note: Only required configuration parameters are listed. Other settings are configurable as needed by user.

SE8600

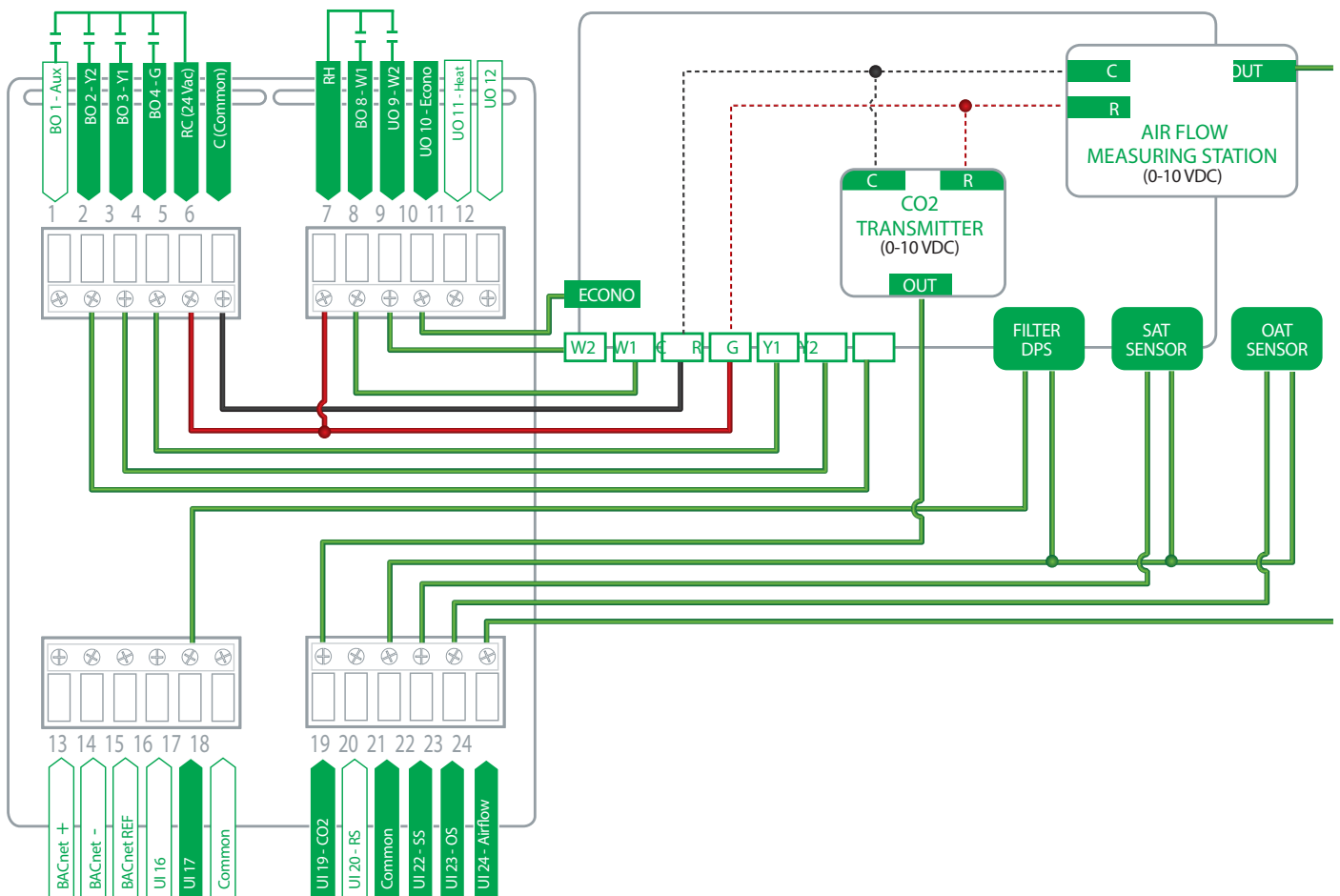

Sequence of Operation and Wiring

Occupied Mode

Setpoints revert to those defined by occupied cooling and heating.

Stand-by Mode (only available when PIR motion detector sensor is used)

Setpoints revert to those defined by stand-by cooling and heating.

Unoccupied Mode

Setpoints revert to those defined by unoccupied heating and cooling.

Occupied Override Mode

System reverts to occupied mode for duration determined by "TocTime" parameter.

In all Occupancy Modes

If room relative humidity is higher than the user-defined Dehumidification setpoint, both Dehumidification, UO12 and Fan BO4, outputs are energized to reach the setpoint and the Room Controller Cooling and Heating outputs will not trigger. If room relative humidity is higher than the dehumidification set point + hysteresis, the Room Controller will energize dehumidification terminal UO12, BO8 and the cooling terminal BO3. During the dehumidification cycle, the Room Controller modulates heating output UO11 to maintain the room temperature set point.

*A multi-pole relay may be required to activate Cooling and Heating stage(s).

Options

- Wireless adapter modules for BACnet models are available. (see Appendix B for network wiring).
- 3 universal inputs can be used and configured for advanced functionality as required by the application.

SE8600UXBXX 2 COOLING / MODULATING HEAT FOR ROOFTOP UNIT AND INDOOR AIR QUALITY

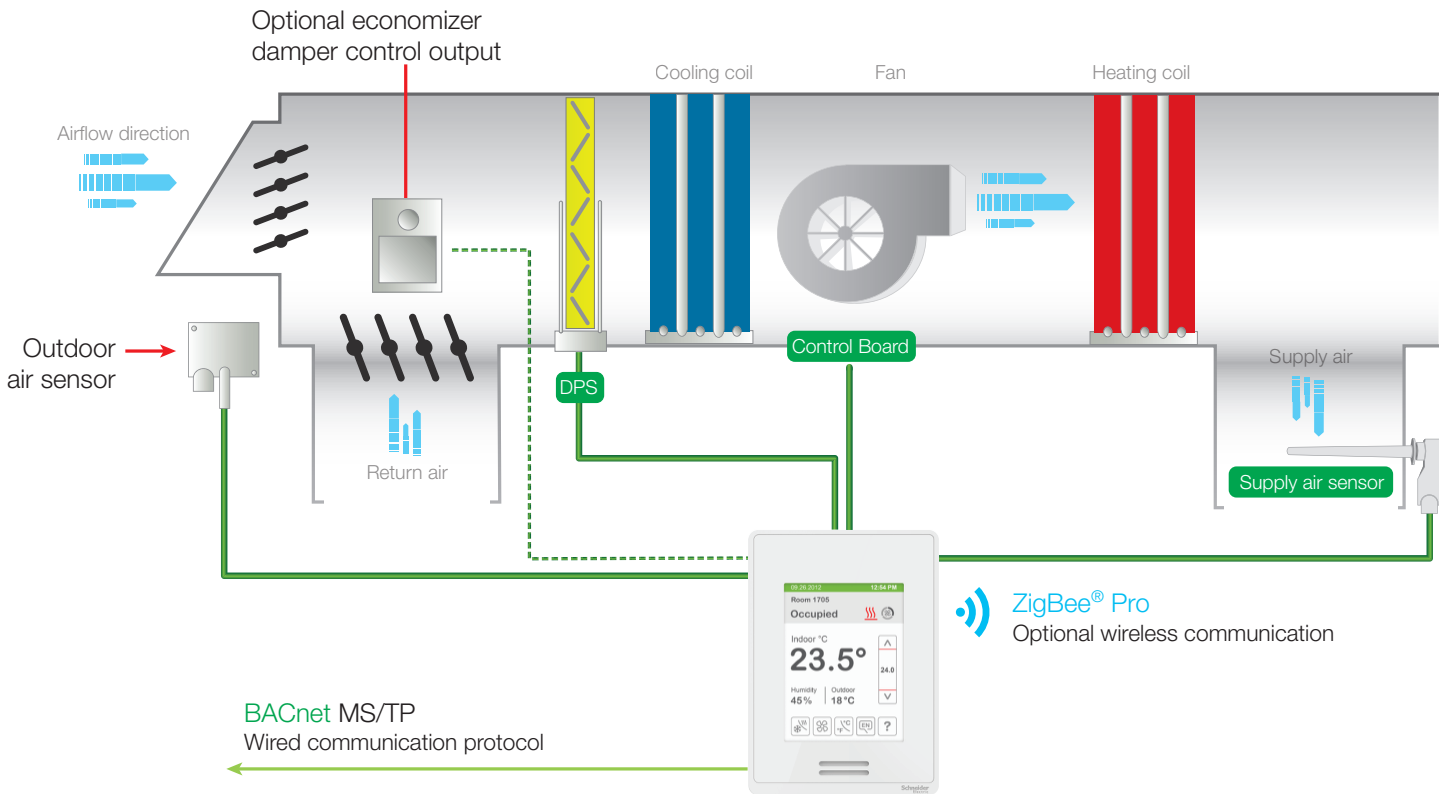

Configuration Parameter Name	Configuration Settings
UI17	Filter
UI19	CO2
Econo. Config	On
FA Range	Set Max CFM, cannot be zero
Min fresh air	Set Min CFM, cannot be zero
Max fresh air	Set Max CFM, cannot be zero
Min CO2	Set Min CO2, cannot be zero
Max CO2	Set Max CO2, cannot be zero

Note: Only required configuration parameters are listed. Other settings are configurable as needed by user.

SE8600

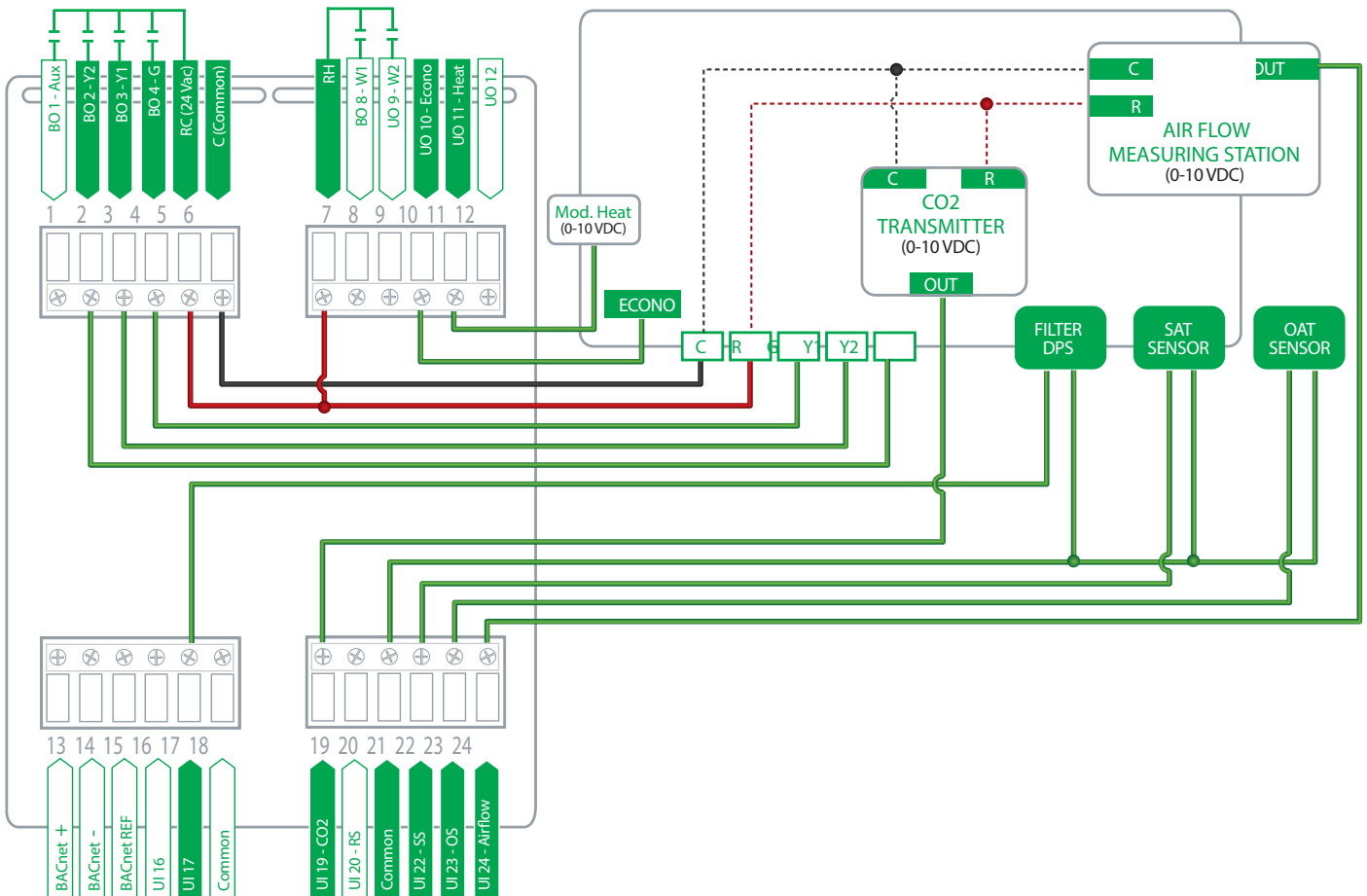

Sequence of Operation and Wiring

Occupied Mode

Setpoints revert to those defined by occupied cooling and heating.

Stand-by Mode (only available when PIR motion detector sensor is used)

Setpoints revert to those defined by stand-by cooling and heating.

Unoccupied Mode

Setpoints revert to those defined by unoccupied heating and cooling.

Occupied Override Mode

System reverts to occupied mode for duration determined by "TocTime" parameter.

In all Occupancy Modes

If room relative humidity is higher than the user-defined Dehumidification setpoint, both Dehumidification, UO12 and Fan BO4, outputs are energized to reach the setpoint and the Room Controller Cooling and Heating outputs will not trigger. If room relative humidity is higher than the dehumidification set point + hysteresis, the Room Controller will energize dehumidification terminal UO12, BO8 and the cooling terminal BO3. During the dehumidification cycle, the Room Controller modulates heating output UO11 to maintain the room temperature set point.

*A multi-pole relay may be required to activate Cooling and Heating stage(s).

Options

- Wireless adapter modules for BACnet models are available. (see Appendix B for network wiring).
- 3 universal inputs can be used and configured for advanced functionality as required by the application.

FRESH AIR DAMPER CONTROL SEQUENCES

The fresh air damper can be controlled through more than one sequence to achieve different control strategies such as free cooling (economizer mode), minimum fresh air control and CO2 level control. Here are the control sequences available:

Note: For the sequences mentioned below, the following conditions must be met in order for the sequences to be performed as stated:

- Max Pos parameter value must be greater than Min Pos Parameter value.
- Mac CO2 parameter value must be greater than Min CO2 Parameter value.
- Max FA parameter value must be greater than Min FA Parameter value.

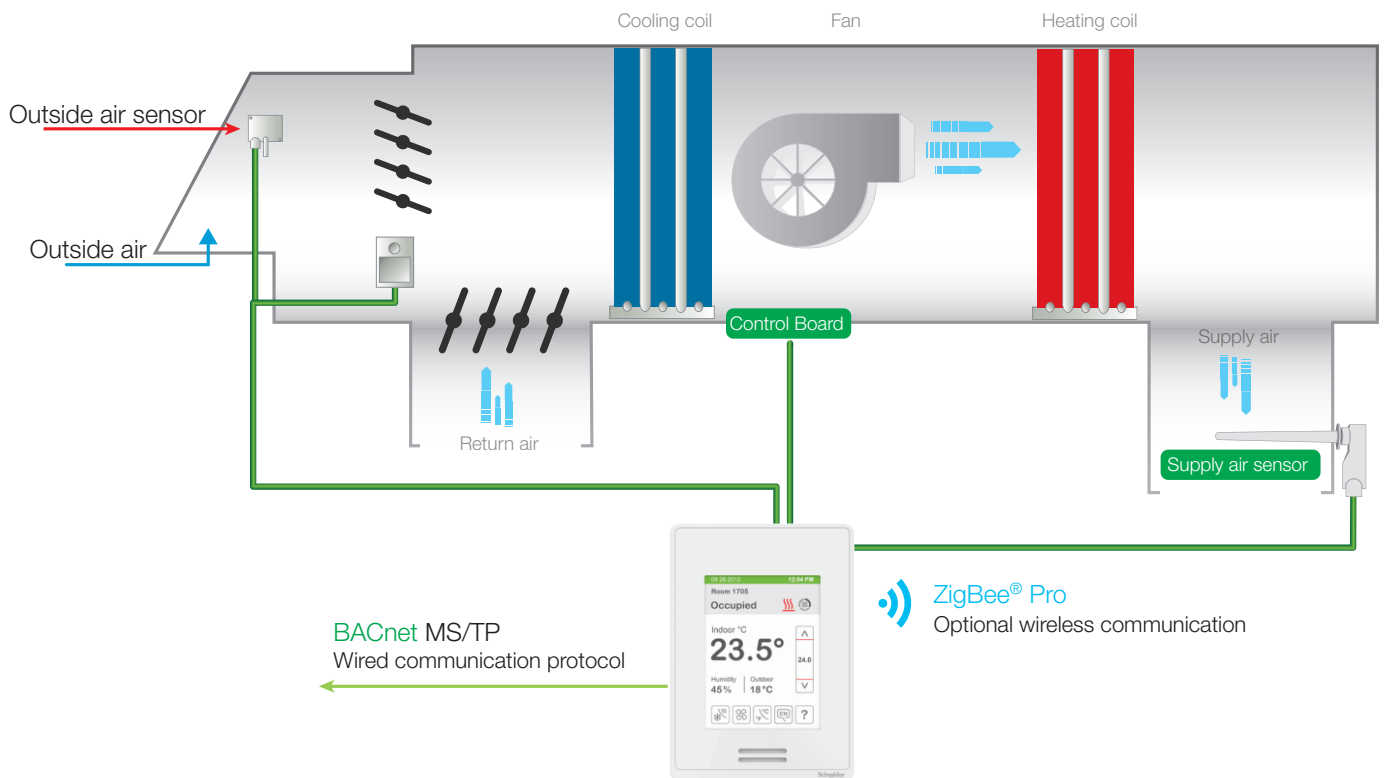

Economizer Control Mode Only

If the fresh air damper is to be used only for free cooling purposes (economizer mode, without fresh air measurement station or CO2 control), only the Min Pos parameter and the free cooling sequence will be active.

- The FA Range parameter should be set to 0 CFM. (Default Value = 0 CFM)
- Set the Chngstpt parameter to desired value which free cooling is enabled. (Default Value = 55°F)

If the outside air temperature is greater than the changeover setpoint, then normal mechanical cooling will be used. If the outside air temperature is less than or equal to the changeover setpoint, then free cooling will be enabled and mechanical cooling stages will be locked out.

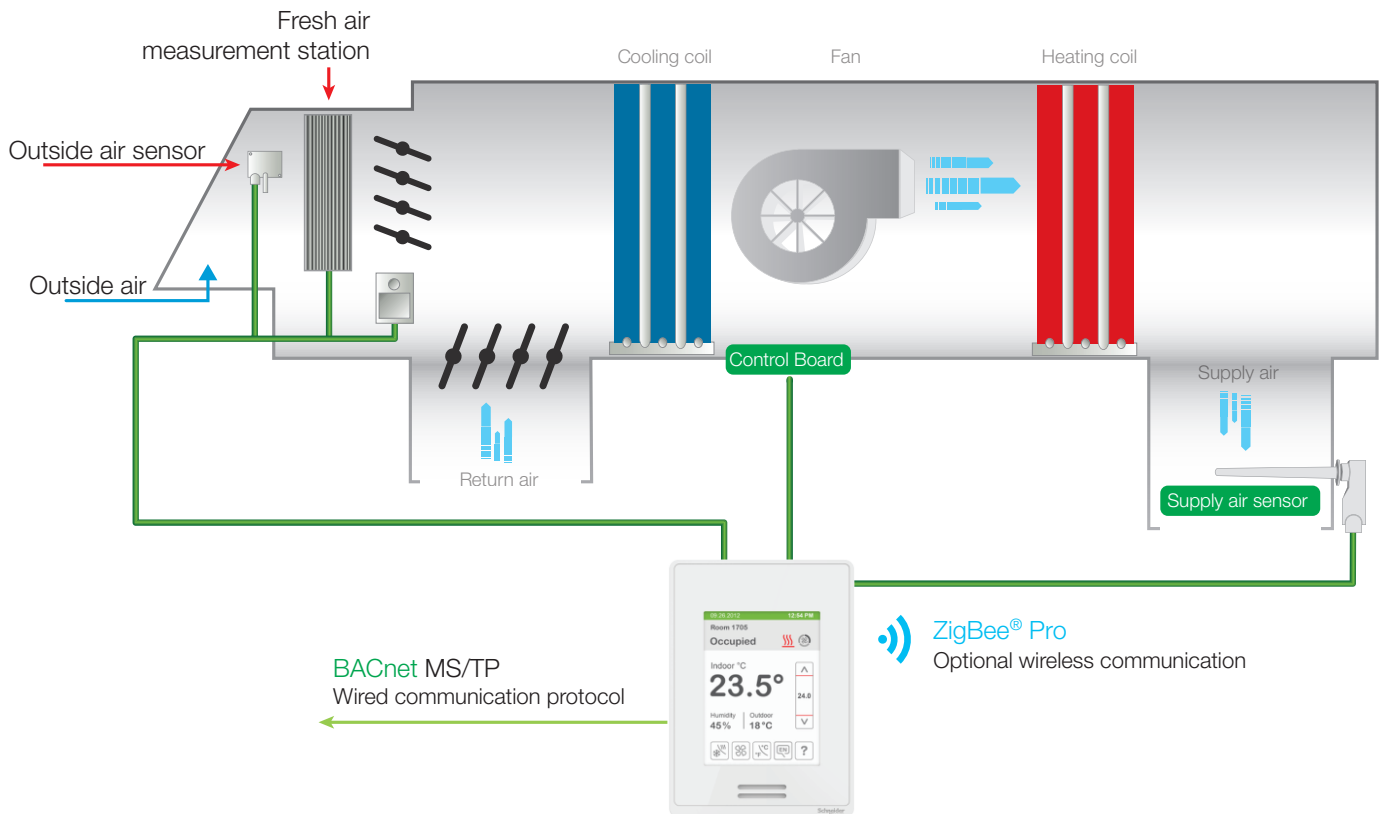

Economizer Control Mode and Fresh Air Measurement Station

If the fresh air damper is to be used for both free cooling and minimum fresh air volume control (economizer mode and fresh air measurement station, but without CO2 level control), only the Min FA parameter and the free cooling sequence will be active.

- The FA Range parameter should be set to a value higher than 0 CFM (0 CFM disables the fresh air control).
- Min FA (minimum fresh air) parameter should be set to the desired level.

The FA Range parameter value should be set to the maximum capacity of the fresh air measurement station. Therefore the relationship between air volumes and input signals can be established. For example, if the fresh air station capacity is 10000 CFM, set FA Range to 10000.

This will set the relationship of 0 VDC = 0 CFM and 10VDC = 10000 CFM.

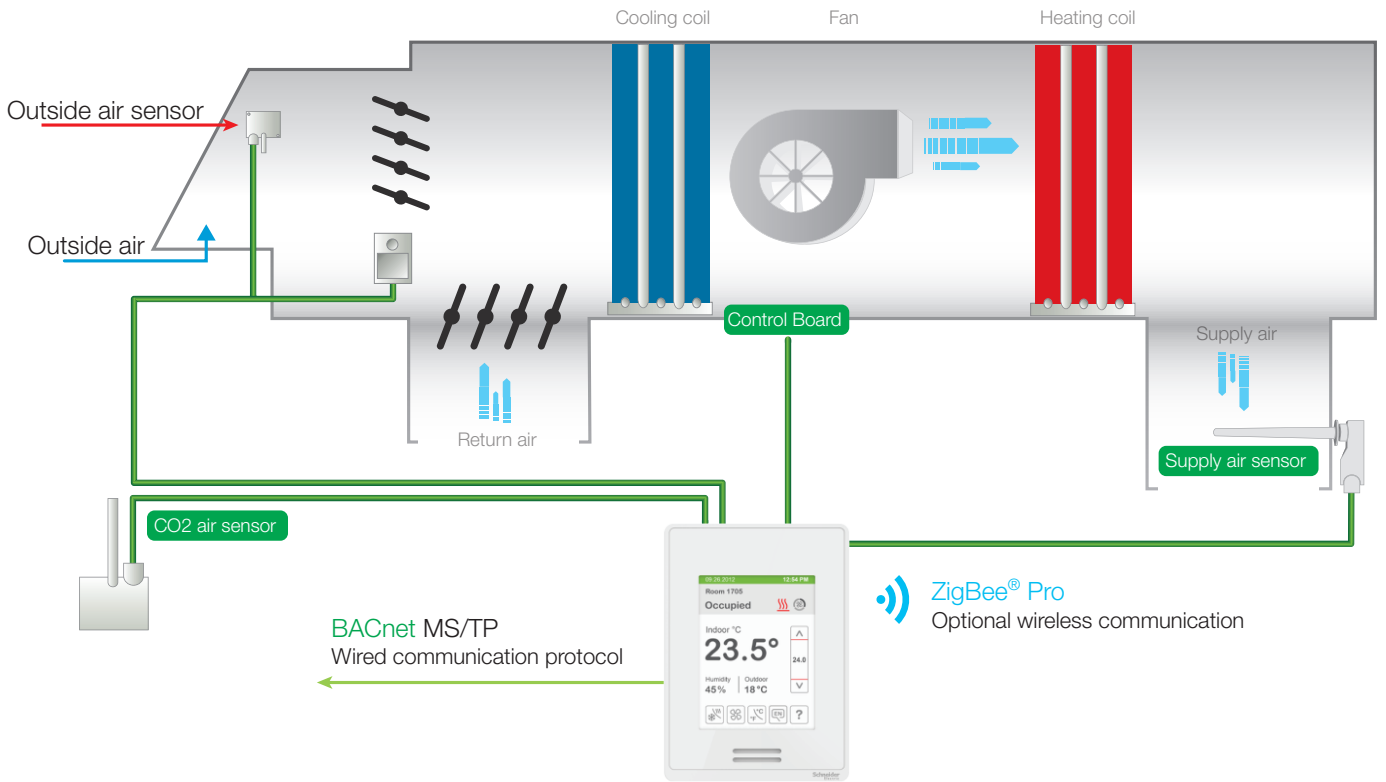

Economizer Control Mode and CO2 Level Control

If the fresh air damper is to be used for both free cooling and CO2 level control (economizer mode and CO2 level control, but without fresh air measurement station), only the Min Pos, Max Pos, Min CO2 and Max CO2 parameters as well as the free cooling sequence will be active.

- The FA Range parameter should be set to 0 CFM.
- Set AI1 parameter to CO2 (0 VDC = 0ppm ; 10VDC = 2000ppm)
- Min Pos, Max Pos, Min CO2 and Max CO2 parameters should be set according to the required setting.

The highest value between free cooling demand output and interpolation output for the fresh air setpoint will be the output to the fresh air damper.

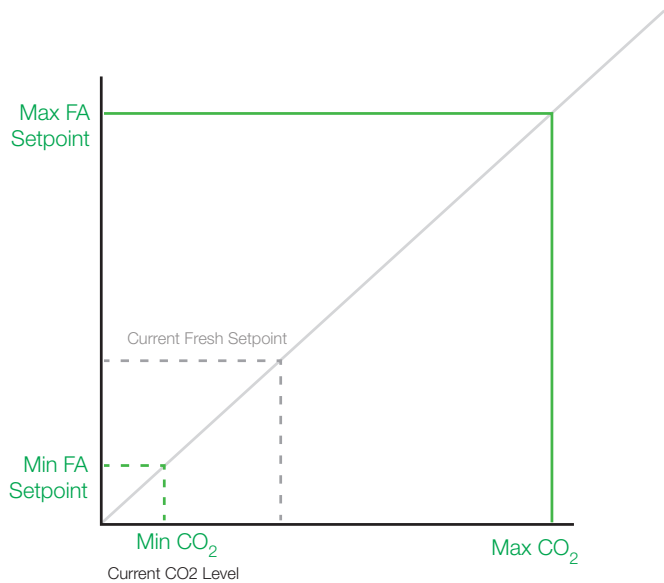

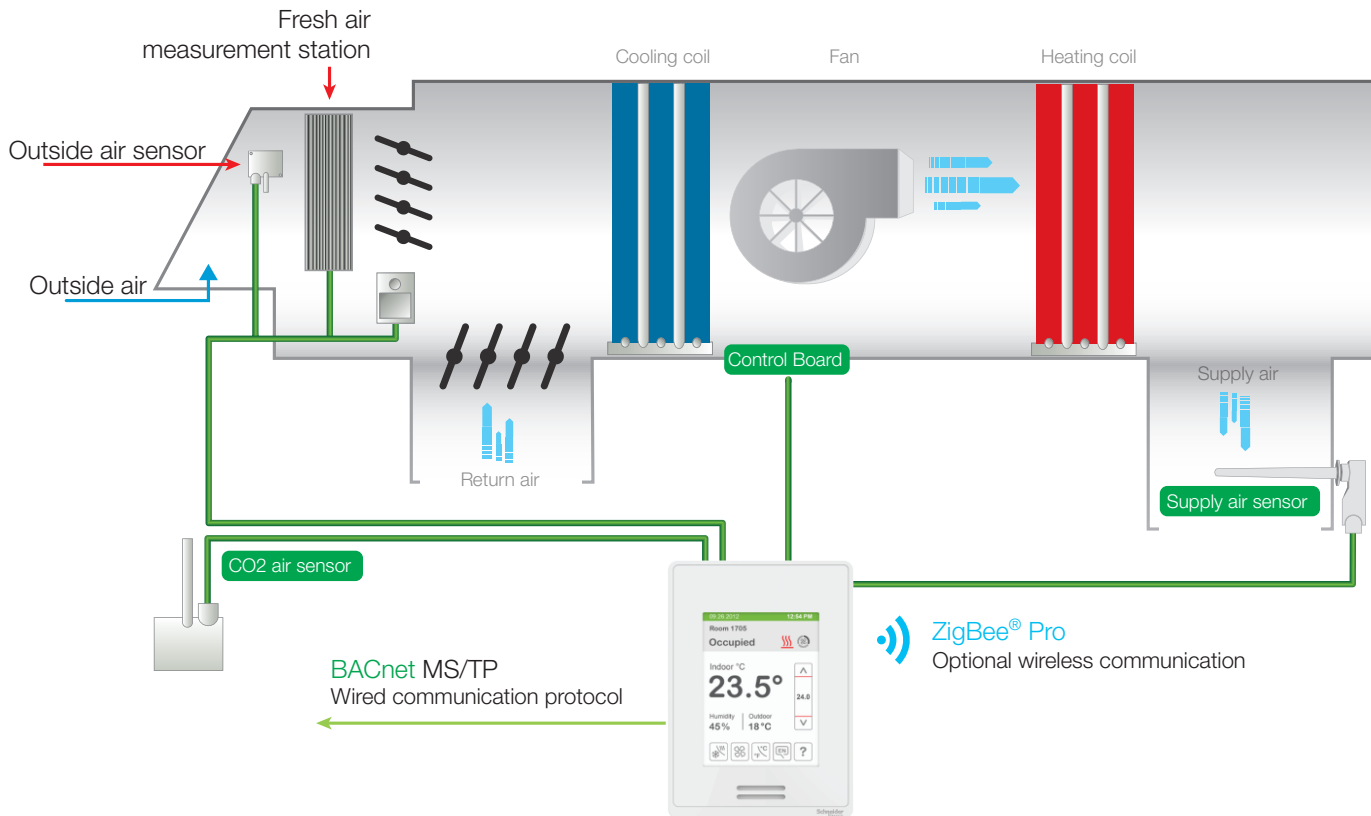

Economizer Control Mode, CO2 Level Control and Fresh Air Measurement Station

If the fresh air damper is to be used for both free cooling and CO2 level control with a fresh air measurement station, only the Min FA, Max FA, Min CO2 and Max CO2 parameters as well as the free cooling sequence will be active.

- The FA Range parameter should be set to something other than 0 CFM.
- Use an air flow transmitter to read fresh air level with AI2 input (0-5 VDC input)
- Min FA, Max FA, Min CO2 and Max CO2 parameters should be set according to the required setting.

The highest value between free cooling demand output and interpolation output for the fresh air setpoint based on the CO2 level will be the output to the fresh air damper.

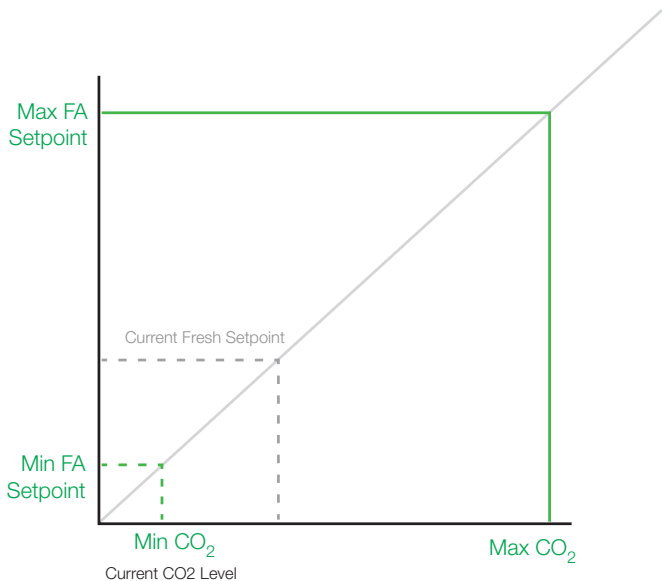

Typical PIR Lens Detection Pattern

Typical detection pattern for the PIR cover is illustrated below.

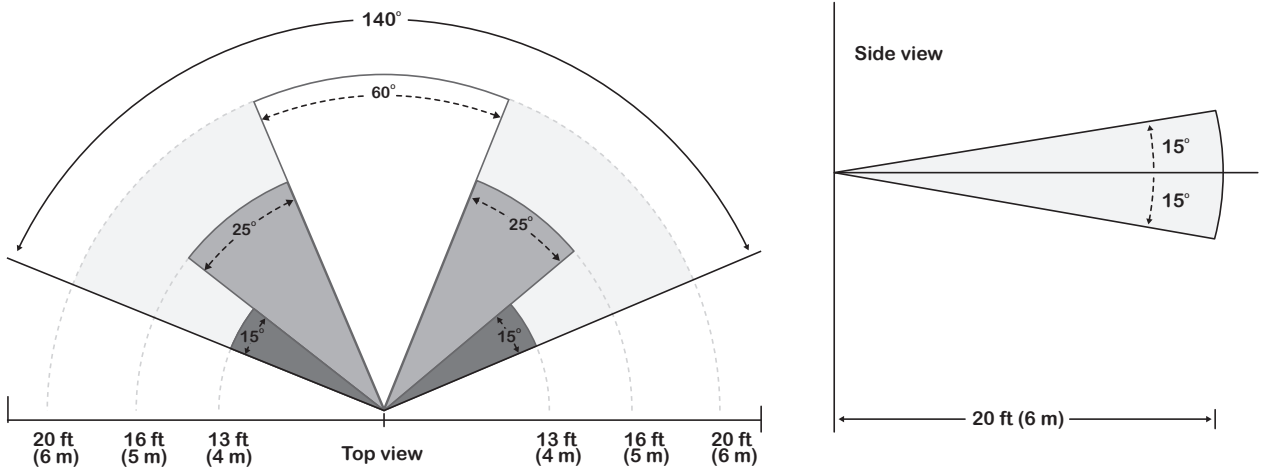

Fresnel lens beam and detection field

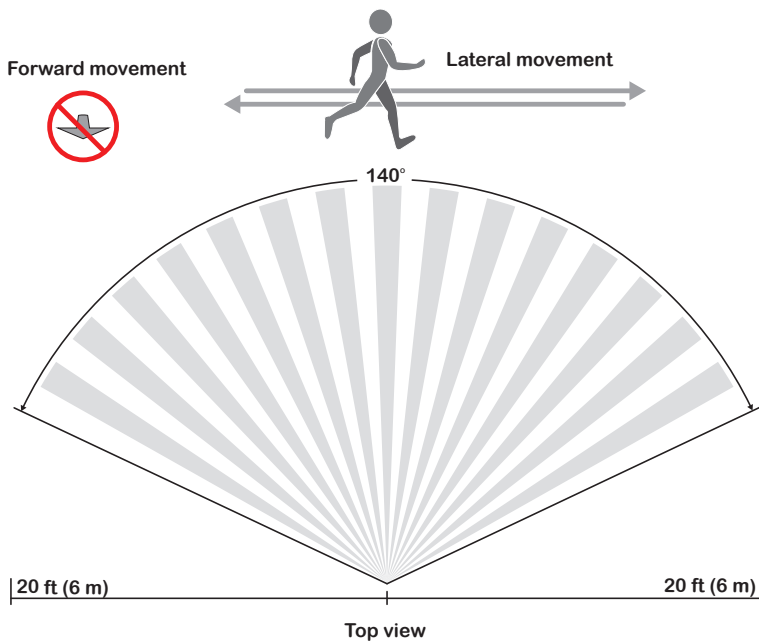

Deployment

It is recommended to install the Room Controller as close to a door as possible (but not so as to be blocked by the door), or in an area with high occupant movement.

Ideally the Room Controller should be installed 5 feet (1.5 meters) above the floor surface to ensure maximum detection range is achieved. As well, Room Controller placement should ensure the occupant crosses the lens beam in a perpendicular path within the prescribed detection zone.

Example of Recommended Deployment

The below shows Room Controllers installed in ideal locations for two rooms.

The examination room shows one Room Controller installed adjacent to the door. In this area of the room, occupant traffic is high and ensures the occupant will almost always cross the PIR detection path laterally and within the detection range.

The waiting room shows one Room Controller installed beside a door in the middle of the room. As shown in the diagram below, occupant traffic is high in several areas of the room including the entrance, waiting room, access to the door and activity around the

reception desk. Moreover, for each case aforementioned, occupant movement almost always moves lateral to the PIR, which ensures detection by the PIR, as well as respecting the PIR detection range of 20 feet (6 meters) at 140°, and 16 feet (5 meters) between 15° to 30° laterally.

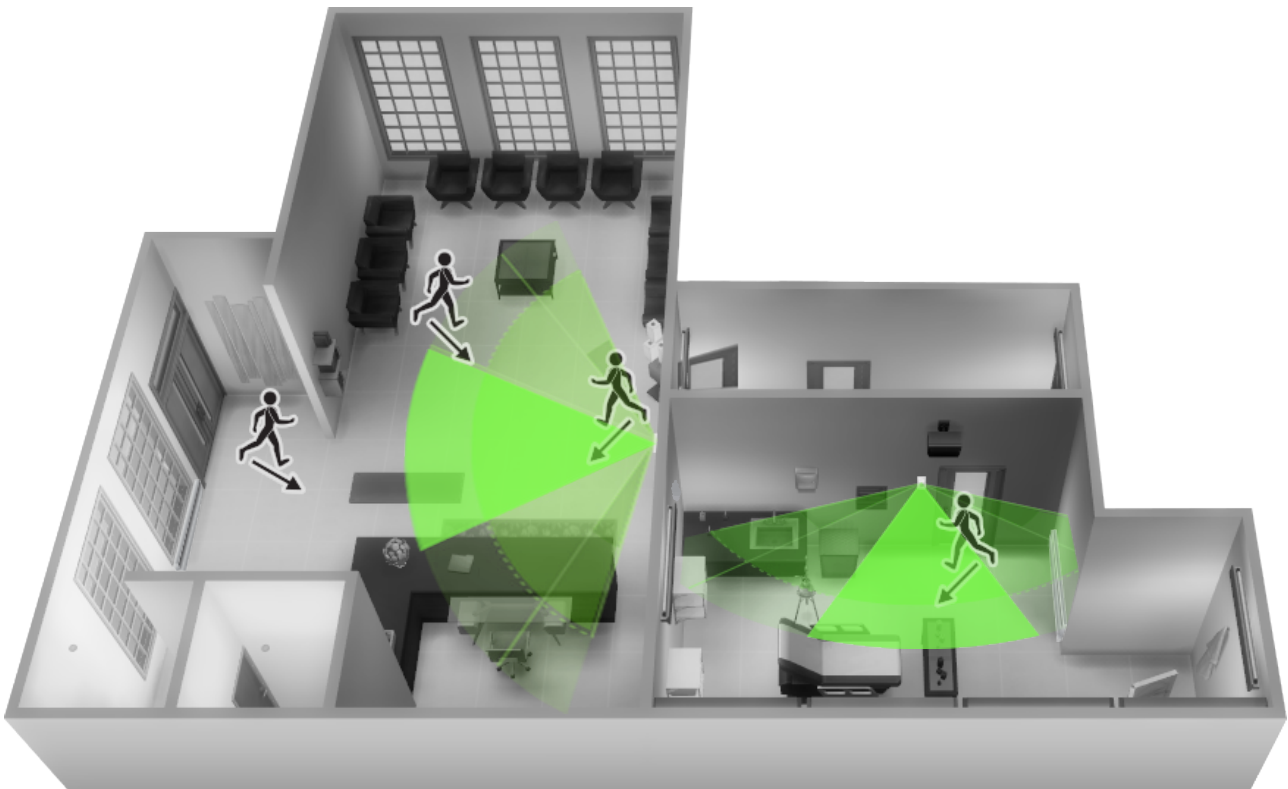

Recommended Installation

Example of Non-Recommended Deployment

The below shows four Room Controllers (two for each room) installed in non-ideal locations for the two rooms.

The examination room shows one Room Controller installed in a low traffic area near the door, and a second Room Controller installed on the wall directly opposite the door. For the Room Controller installed in the corner wall near the door, the PIR could be blocked by the opened door, thereby restricting PIR detection. For the second Room Controller installed opposite the door, the PIR detection could fall outside the specified detection zone, while at the same time most occupant movement may not respect lateral crossing patterns for PIR detection.

The waiting room shows one Room Controller installed near the entrance, and a second Room Controller installed beside the reception area. For the Room Controller installed at the entrance, the opening/closing of the door creates high probability the PIR would get blocked, and therefore, occupancy going undetected. For the Room Controller installed beside the reception area, occupant traffic could fall outside the detection zone, while the receptionist would often be below the 5 foot recommended installation height for the Room Controller.



Non-Recommended Installation

APPENDIX B - OPTIONAL NETWORK SET-UP

BACnet communication wiring

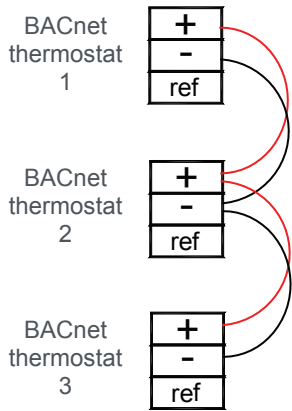

Notes:

- Wiring should be daisy chained
- Respect polarity
- If using 2 conductors shielded wires, connect the shield of each feed together on the back of the controller. ONLY ground the shield at one location. DO NOT connect the shield to the ref terminal.

Wireless Communication



No communication wires required

APPENDIX C - CONTROLLERS' OCCUPANCY SEQUENCE OF OPERATION SCHEMATIC

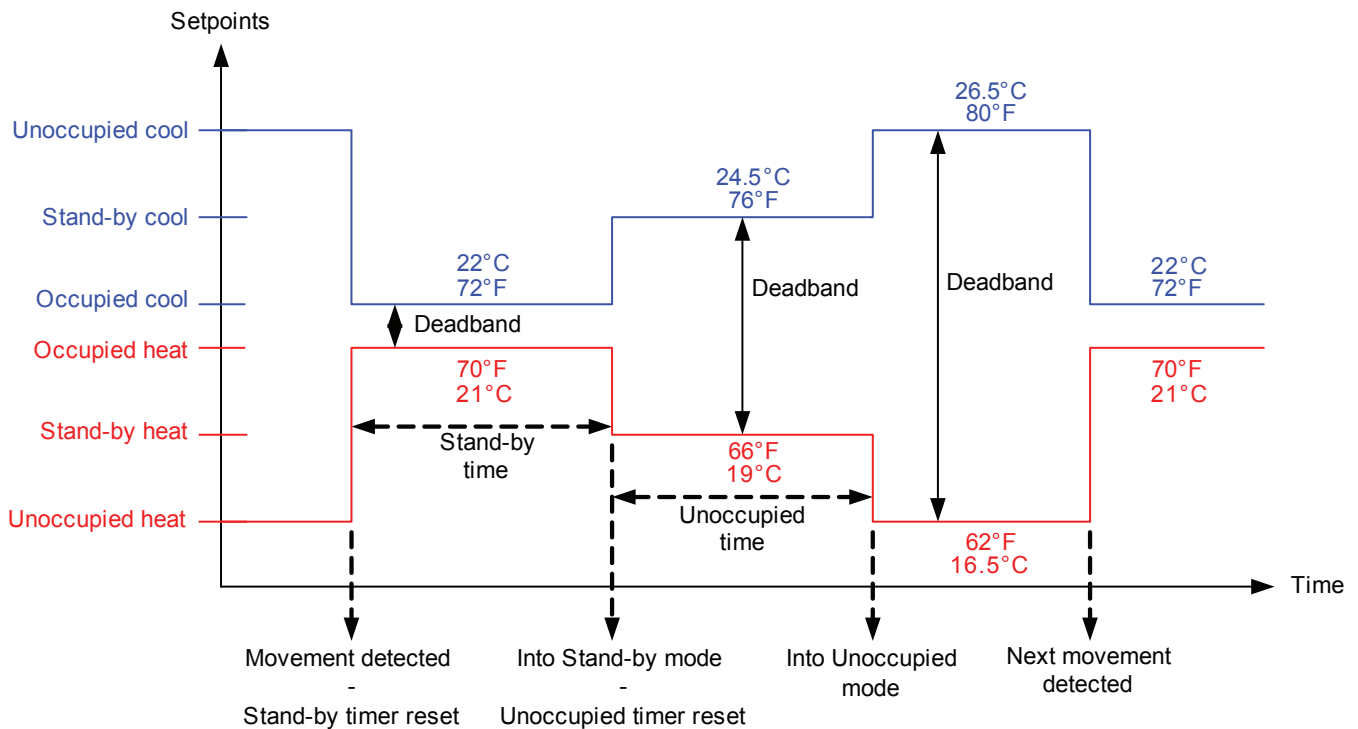

APPENDIX D - WIRELESS SENSORS

Wireless ZigBee Pro Motion Sensors

Rooftop Unit and Indoor Air Quality Controllers with ZigBee Pro wireless sensors can be used in stand-alone mode, or with integration to a central management system, to allow for advanced functions such as central reservation and occupancy functions.

Up to ten different ZigBee motion sensors and switches (SED-WMS, SED-CMS, or SED-WDS) can be used with a SE8600 Room Controller.

No tools are required for commissioning or servicing the ZigBee devices. A simple interface on the devices with an on-board LED and hidden switch provides all required functions for local interaction. The SE8600 user interface has screens used to pair and configure ZigBee devices (SED-WMS, SED-CMS, or SED-WDS only). Local information for battery life and connectivity (heartbeat) are also displayed through the ZigBee Pro wireless network.

MODEL SELECTION

Window Switch	Door Switch
Door/window switch	SED-WDS-P-5045
Wall mounted motion sensor	SED-WMS-P-5045
Ceiling mounted motion sensor	SED-CMS-P-5045

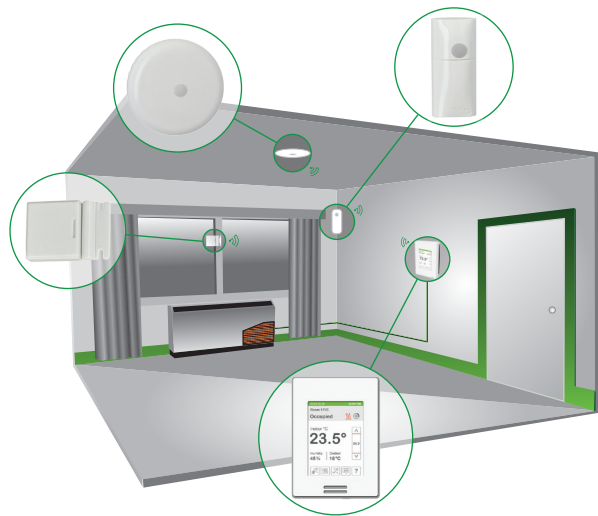

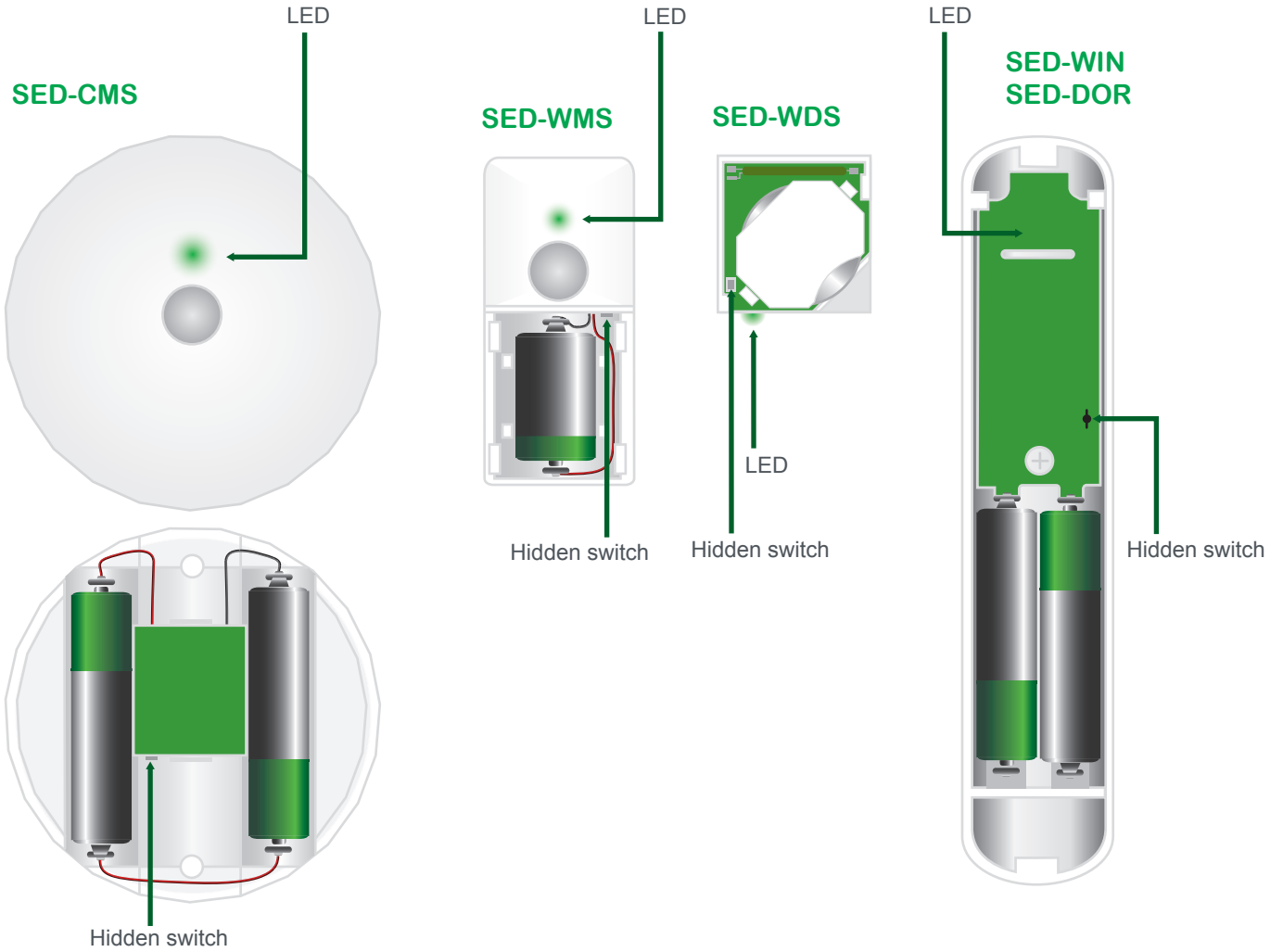

APPENDIX E: TERMINAL CORRESPONDENCE

The terminals of an SE8600 are identified differently and have a wider range of possible functions compared to those of any of the SE7000 series Room Controllers. Nonetheless, there is a direct correspondence of functions between the terminals of the SE7000 series and the SE8600 series. Consult the table below to verify the appropriate terminal when replacing a SE7000 Room Controller with a SE8600 Room Controller.

SE7000		SE8600	
Terminal name	Terminal ID	Terminal name	Terminal ID
Binary Input 1	BI1	Universal Input 16	UI16
Binary Input 2	BI2	Universal Input 17	UI17
Universal Input 3	UI3	Universal Input 19	UI19
Sensor Common	Scom	Terminal 18 Common	COM
Remote Sensor	RS	Universal Input 20	UI20 - RS
Sensor Common	Scom	Terminal 21 Common	COM
Mix/Supply Sensor	MS	Universal Input 22	UI22 - SS