

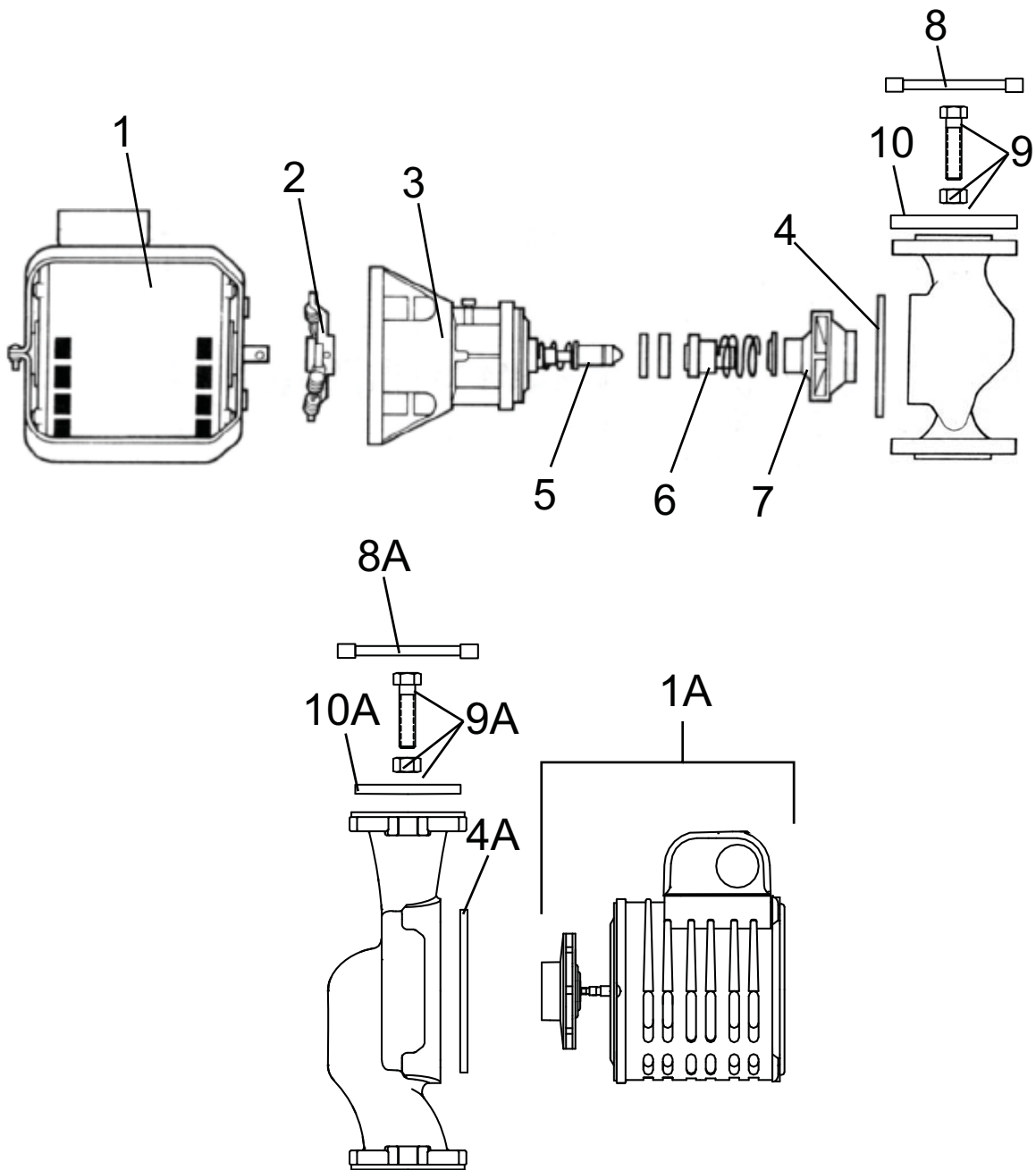

Replacement Parts List

PARTS & SERVICE DEPARTMENT
Nashville, Tennessee
615-889-8900 • Fax: 615-882-2918
parts_team@lochinvar.com
www.Lochinvar.com

CIRCULATING PUMPS for Domestic Hot Water



CW(N,L) 495-745 , EW(N,L)150-300 , CF(N,L)401-751			ARM3044PAB(PBF) 1/4 HP
ITEM NO.	PART NUMBER	DESCRIPTION	
1	ARM1019	MOTOR	
2	ARM1007	COUPLER	
3	ARM1046	SEAL BEARING ASSEMBLY	
4	ARM1011	VOLUTE GASKET	
5	ARM1002	BEARING MODULE	
6	ARM1001	SEAL KIT	
7	ARM1023	IMPELLER	
8	ARM1033	FLANGE PAB - 2" (REQ. 2)	
8	ARM1029	FLANGE PBF - 2" (REQ. 2)	
9	ARM1058	BOLT & GASKET KIT	
10	ARM1014	FLANGE GASKET	
CP(N,L)401-751, CS(N,L)495-745			ARM3044PABTE 1/4 HP
ITEM NO.	PART NUMBER	DESCRIPTION	
1	ARM1045	MOTOR	
2	ARM1007	COUPLER	
3	ARM1046	SEAL BEARING ASSEMBLY	
4	ARM1011	VOLUTE GASKET	
5	ARM1002	BEARING MODULE	
6	ARM1001	SEAL KIT	
7	ARM1023	IMPELLER	
8	ARM1033	FLANGE - 2" (REQ. 2)	
9	ARM1058	BOLT & GASKET KIT	
10	ARM1014	FLANGE GASKET	
CF(N,L) 991-2071 & 990-2070 , CW(N,L) 986-2066 & 985-2065			ARM3024PAB(PBF) 1/2 HP
ITEM NO.	PART NUMBER	DESCRIPTION	
1	ARM1016	MOTOR	
2	ARM1008	COUPLER	
3	ARM1005	SEAL BEARING ASSEMBLY	
4	ARM1010	VOLUTE GASKET	
5	ARM1002	BEARING MODULE	
6	ARM1001	SEAL KIT	
7	ARM1026	IMPELLER	
8	TFL2079	FLANGE PAB - 2.5" (REQ. 2)	
8	ARM1030	FLANGE PBF - 2.5" (REQ. 2)	
9	ARM1050	BOLT & GASKET KIT	
10	ARM1013	FLANGE GASKET	
CP(N,L) 991-1441 & 990-2070, CS(N,L)985-2065			ARM3024PABTE 1/2 HP
ITEM NO.	PART NUMBER	DESCRIPTION	
1	ARM1040	MOTOR	
2	ARM1008	COUPLER	
3	ARM1005	SEAL BEARING ASSEMBLY	
4	ARM1010	VOLUTE GASKET	
5	ARM1002	BEARING MODULE	
6	ARM1001	SEAL KIT	
7	ARM1026	IMPELLER	
8	TFL2079	FLANGE - 2.5" (REQ. 2)	
9	ARM1060	BOLT & GASKET KIT	
10	ARM1013	FLANGE GASKET	
CP(N,L) 1801-2071			ARM3072PABTE 3/4 HP
ITEM NO.	PART NUMBER	DESCRIPTION	
1	ARM1069	MOTOR	
2	ARM1008	COUPLER	
3	ARM1005	SEAL BEARING ASSEMBLY	
4	ARM1010	VOLUTE GASKET	
5	ARM1002	BEARING MODULE	
6	ARM1001	SEAL KIT	
7	ARM1051	IMPELLER	
8	TFL2079	FLANGE - 2.5" (REQ. 2)	
9	ARM1050	BOLT & GASKET KIT	
10	ARM1013	FLANGE GASKET	

PLEASE HAVE MODEL AND SERIAL NUMBER WHEN ORDERING PARTS

PF(N,L)250-1000 BEFORE A05H00172528			ARM3022PAB(PBF) 1/2 HP
ITEM NO.	PART NUMBER	DESCRIPTION	
1	ARM1017	MOTOR	
2	ARM1008	COUPLER	
3	ARM1005	SEAL BEARING ASSEMBLY	
4	ARM1010	VOLUTE GASKET	
5	ARM1002	BEARING MODULE	
6	ARM1001	SEAL KIT	
7	ARM1026	IMPELLER	
8	ARM1032	FLANGE PAB - 2" (REQ. 2)	
8	ARM1009	FLANGE PBF - 2" (REQ. 2)	
9	ARM1053	BOLT & GASKET KIT	
10	ARM1013	FLANGE GASKET	
PF(N,L)501 A05H00172528 & AFTER			PUM3006 2/5 HP
PF(N,L)502 - 1302			PUM3013 2/5 HP
ITEM NO.	PART NUMBER	DESCRIPTION	
1A	PUM10002	PUMP LESS VOLUTE	
4A	ARM1063	VOLUTE GASKET	
8A	ARM1032	FLANGE - 2" (REQ. 2)	
9A	ARM1053	BOLT & GASKET KIT	
10A	ARM1013	FLANGE GASKET	
PF(N,L)751-1300 A05H00172528 & AFTER			ARM3025PAB 1/2 HP
ITEM NO.	PART NUMBER	DESCRIPTION	
1	ARM1067	MOTOR	
2	ARM1008	COUPLER	
3	ARM1005	SEAL BEARING ASSEMBLY	
4	ARM1010	VOLUTE GASKET	
5	ARM1002	BEARING MODULE	
6	ARM1001	SEAL KIT	
7	ARM1026	IMPELLER	
8	TFL2079	FLANGE - 2.5" (REQ. 2)	
9	ARM1060	BOLT & GASKET KIT	
10	ARM1013	FLANGE GASKET	
PF(N,L)1501-2001 & 1500-2000			ARM3077PAB(PBF) 3/4 HP
ITEM NO.	PART NUMBER	DESCRIPTION	
1	ARM1049	MOTOR	
2	ARM1008	COUPLER	
3	ARM1005	SEAL BEARING ASSEMBLY	
4	ARM1010	VOLUTE GASKET	
5	ARM1002	BEARING MODULE	
6	ARM1001	SEAL KIT	
7	ARM1051	IMPELLER	
8	TFL2079	FLANGE PAB & PBF - 2.5" (REQ. 2)	
9	ARM1060	BOLT & GASKET KIT	
10	ARM1013	FLANGE GASKET	
CW2620-M9 & CWN3080-M9-100			ARM3032PAB(PBF) 1/3 HP
ITEM NO.	PART NUMBER	DESCRIPTION	
1	ARM1020	MOTOR	
2	ARM1007	COUPLER	
3	ARM1046	SEAL BEARING ASSEMBLY	
4	ARM1011	VOLUTE GASKET	
5	ARM1002	BEARING MODULE	
6	ARM1001	SEAL KIT	
7	ARM1024	IMPELLER	
8	ARM1068	FLANGE PAB - 3" (REQ. 2)	
8	ARM1027	FLANGE PBF - 3" (REQ. 2)	
9	ARM1072	BOLT & GASKET KIT	
10	ARM1014	FLANGE GASKET	

PLEASE HAVE MODEL AND SERIAL NUMBER WHEN ORDERING PARTS

ITEM NO.	PART NUMBER	DESCRIPTION
1A	PUM10000	PUMP LESS VOLUTE
4A	ARM1063	VOLUTE GASKET
8A	ARM1080	FLANGE PAB - 1.5" (REQ. 2)
8A	ARM1036	FLANGE PBF - 1.5" (REQ. 2)
9A	ARM1057	BOLT & GASKET KIT
10A	ARM1081	FLANGE GASKET

EP150-300 ARM3074PAB(PBF) 1/6 HP

ITEM NO.	PART NUMBER	DESCRIPTION
1A	PUM10001	PUMP LESS VOLUTE
4A	ARM1063	VOLUTE GASKET
8A	ARM1032	FLANGE PAB - 2" (REQ. 2)
8A	ARM1009	FLANGE PBF - 2" (REQ. 2)
9A	ARM1053	BOLT & GASKET KIT
10A	ARM1048	FLANGE GASKET

IB-IW(N,L)1500-2000 ARM3072PAB(PBF) 3/4 HP

ITEM NO.	PART NUMBER	DESCRIPTION
1	ARM1049	MOTOR
2	ARM1008	COUPLER
3	ARM1005	SEAL BEARING ASSEMBLY
4	ARM1010	VOLUTE GASKET
5	ARM1002	BEARING MODULE
6	ARM1001	SEAL KIT
7	ARM1051	IMPELLER
8	TFL2079	FLANGE PAB & PBF - 2.5" (REQ. 2)
9	ARM1060	BOLT & GASKET KIT
10	ARM1013	FLANGE GASKET

AW150-199 PUM3010 1/6 HP

ITEM NO.	PART NUMBER	DESCRIPTION
1A	PUM10003	PUMP LESS VOLUTE
4A	ARM1063	VOLUTE GASKET
8A	ARM1078	FLANGE - 1.25" (REQ. 2)
9A	ARM1074	BOLT & GASKET KIT
10A	ARM1015	FLANGE GASKET

AW285 PUM3011 2/5 HP

ITEM NO.	PART NUMBER	DESCRIPTION
1A	PUM10004	PUMP LESS VOLUTE
4A	ARM1063	VOLUTE GASKET
8A	TFL2096	FLANGE - 2" (REQ. 2)
9A	ARM1074	BOLT & GASKET KIT
10A	ARM1015	FLANGE GASKET
-	TFL2117	PUMP FLANGE AND HARDWARE KIT USED PRIOR TO C08

AW399 PUM3012 2/5 HP

ITEM NO.	PART NUMBER	DESCRIPTION
1A	PUM10006	PUMP LESS VOLUTE
4A	ARM1063	VOLUTE GASKET
8A	TFL2096	FLANGE - 2" (REQ. 2)
9A	ARM1057	BOLT & GASKET KIT
10A	ARM1081	FLANGE GASKET
-	TFL2118	PUMP FLANGE AND HARDWARE KIT USED PRIOR TO C08

AW500-600 PUM30003 2/5 HP

ITEM NO.	PART NUMBER	DESCRIPTION
1A	PUM10005	PUMP LESS VOLUTE
4A	ARM1063	VOLUTE GASKET
8A	TFL2096	FLANGE - 2" (REQ. 2)
9A	ARM1057	BOLT & GASKET KIT
10A	ARM1081	FLANGE GASKET

PLEASE HAVE MODEL AND SERIAL NUMBER WHEN ORDERING PARTS