

Zio[®]/Zio Plus LCD Wall Modules

TR70, TR71, TR75 WITH Sylk[®] Bus

SPECIFICATION DATA



GENERAL

The TR70 Series Zio (TR70/TR70-H, TR71/TR71-H) and Zio Plus (TR75/TR75-H) are 2-wire, non-polarity sensitive, Sylk bus communicating wall modules for use with Spyder[®] and ComfortPoint[™] programmable controllers.

All models have a space-temperature sensor, network bus jack, and an LCD panel with three softkeys and two Up/Down adjustment keys. The TR7-H, TR71-H and TR75-H models include an onboard humidity sensor.

NOTE: Refer to the **Zio/Zio Plus LCD Wall Modules Operating Guide (form 63-2719)** for information about customizing the wall module configuration in the **WEBS-AX Workbench**, such as modifying the default Home screens or creating your own application.

FEATURES

The TR70 Series wall modules include:

- Ability to control tenant access to controller parameters via password protection.
- Ability to assign labels for enumerated values.
- Customized parameter access, by using the Honeywell WEBS-AX Workbench tool.
- Ability to link setpoint limits to a network variable.

- Programmable for: Home screen options, tenant access, contractor access, optional password protection to contractor mode, access to controller parameters, setpoint, override, fan, and other parameters.
- Ability to access and adjust most parameters in the programmable controller.
- TR75 can access and adjust the controller schedule.
- Ability to balance the VAV system from the wall module.
- Home screen can display one to three of any of the following parameters: Temperature Setpoint, Room Temperature, Room Humidity, Outdoor Humidity, Outdoor Temperature, and Time, or one of virtually any parameter in the controller.
- Network bus jack.
- Simple 2-wire terminal connection to the programmable controller (includes power) and an optional 2-wire terminal connection for the network. All connections are polarity insensitive.
- Permanent retention of user configuration, including setpoints after a power outage.

Table 1. TR70 Series Features.

Features	Zio TR70	Zio TR71	Zio Plus TR75
Scheduling			x
Parameter Memory (bytes)	1K	2K	4.9K
Up to four Zios on Sylk	x*	x	x
Enumerated Values		x	x
Setpoint Limits as NVs – linking now possible		x	x
System and Fan command as NVs		x	x
Password protection		x	x
Firmware version/model visible on display		x	x
0.5 and 5 value increments		x	x
"-" and "/" characters in parameter names		x	x

* Support for up to four TR71 and/or TR75s per Spyder, and if a TR70 is present, a maximum of three Zios (any combination of models) are allowed.



SPECIFICATIONS

Compatibility: Full feature set, including scheduling and password protection requires the latest Spyder firmware (field upgradeable with Spyder Flash Tool), Spyder Tool version greater than 5.18, and WEBS-AX Workbench version 3.4.57 or greater.

Construction: Two-piece construction, cover and internally wired subbase. Field wiring, 18 to 24 AWG (0.82 to 0.20 sq. mm), connects to a terminal block in the subbase.

Mounting Options: The LCD wall modules can be mounted on a standard two by four inch junction box or on a 60 mm diameter junction box. The modules may be mounted up to 500 ft. (150 m) from the programmable controller. Twisted pair wiring is recommended for distances longer than 100 ft. (30 m).

Dimensions (H/W/D): See Fig. 2 on page 2.

Environmental Ratings:

Operating Temperature: 30°F to 110°F (-1°C to 43°C)
 Shipping Temperature: -40°F to 150°F (-40°C to 65.5°C)
 Relative Humidity: 5% to 95% non-condensing

Temperature Setpoint Range: Default range is 55°F to 85°F (10°C to 35°C); configurable for other ranges.

Temperature Sensor Accuracy: ±0.36°F at 77°F (±0.2°C at 25°C)

Humidity Sensor Accuracy (TR71-H/TR75-H only): ±5% RH from 20% to 80% RH

Power: 18 Vdc power is supplied to the wall module from the 2-wire S-BUS connection to the programmable controller.

Accessories: 50007298-001 (pack of 12) medium, cover plate; 6-7/8 x 5 in. (175 x 127 mm).

Approvals: CE; UL94-HB plastic enclosure; FCC Part 15, Class B

Terminal Wiring Location

Fig. 1 illustrates the location of the terminal block and other features on the TR70 Series wall modules.

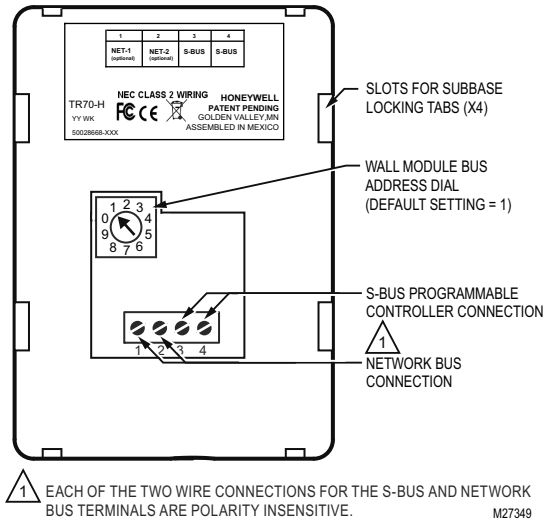

Fig. 1. LCD wall module components (rear view).

NOTE: 18 Vdc power for the LCD wall modules is supplied from the programmable controller.

Module Dimensions

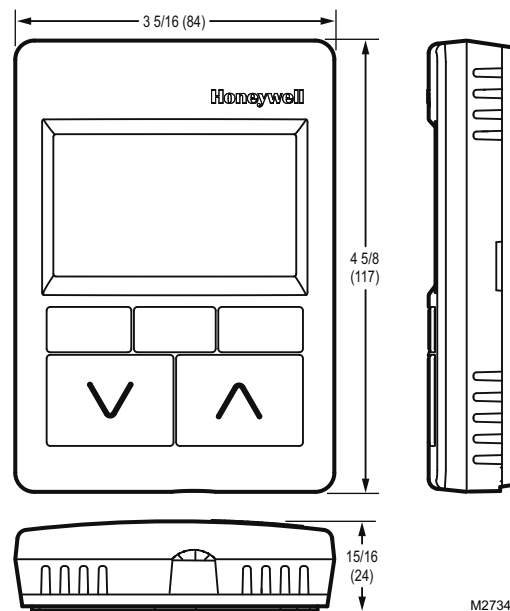

Fig. 2. Wall module dimensions in inches (mm).

Communications

The wall modules use a sensor bus (S-BUS) for communications with the programmable controller.

For network communication, the building's LON or BACnet® network wires connect to the two terminals (NET-1 and NET-2). See Fig. 1. A network bus port is accessible at the bottom of the wall module by removing the jack plug.

The network bus and S-BUS terminals (see Fig. 1) are insensitive to polarity, minimizing installation errors due to mis-wiring. The recommended wire for the network bus and

S-BUS is 18-24 AWG (0.82 to 0.20 sq mm) single twisted pair, solid or stranded wire, unshielded. Standard thermostat wire (non-twisted pair) can be used for runs up to 100ft (30m).

LCD Display

The LCD display may be customized for tenant and contractor users. The following are a few samples of the various Home screens that are configurable for the LCD Wall Modules. Not all possible Home screens are illustrated here. There are many other configurable Home screens.

NOTES:

1. Home screens can display one to three of any of the following parameters: Temperature Setpoint, Room Temperature, Room Humidity, Outdoor Humidity, Outdoor Temperature, and Time, or one of virtually any parameter in the controller.
2. Refer to the Zio/Zio Plus LCD Wall Modules Operating Guide (form 63-2719) for information about customizing the wall module configuration in the WEBS-AX Workbench, such as modifying the default Home screens or creating your own application.

Sample Tenant LCD Displays

The Fan and Occupied settings are optional for Home screen setup. If there are no parameters configured for Tenant access, the “View More” softkey does not display on the Tenant Home screen.

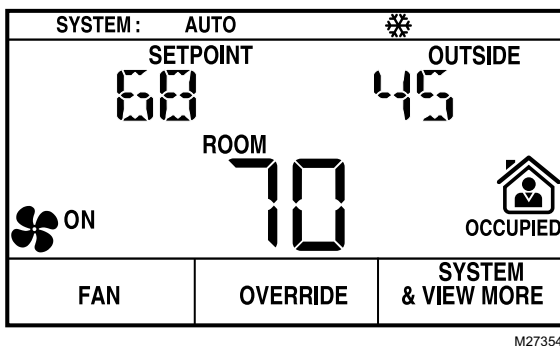

M27354

Fig. 3. Sample Tenant Home screen with System Status, Setpoint, Outside Temperature, and Room Temperature (predominant).

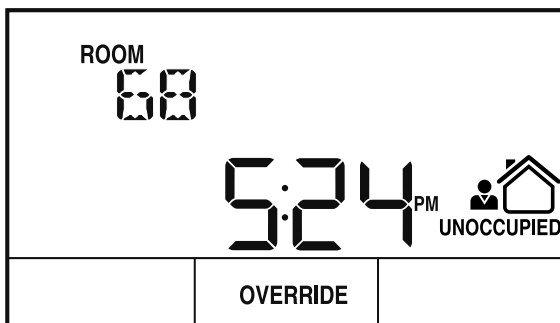

M27379

Fig. 4. Sample Tenant Home screen with Room Temperature and Time (predominant).

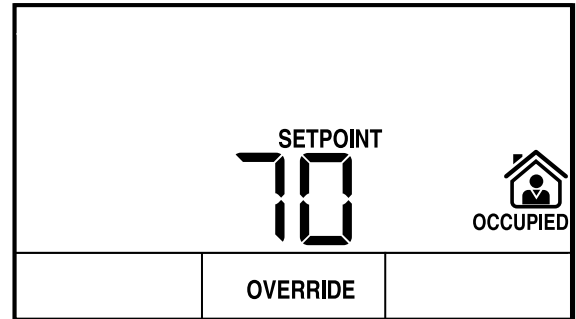

M27377

Fig. 5. Sample Tenant Home screen with Setpoint display only.

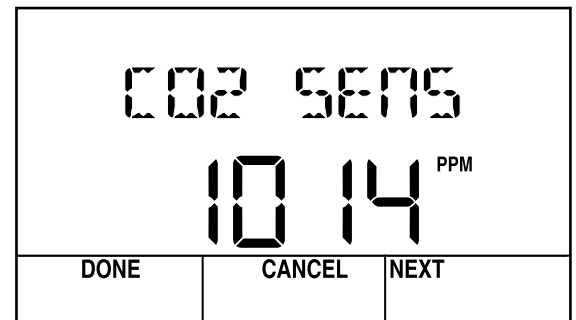

M27356

Fig. 6. Sample Tenant “View More” display showing CO₂ sensor value from controller.

NOTE: Any configured parameter may be displayed.

Sample Contractor LCD Displays

The Contractor mode allows advanced options using the softkeys. Contractor mode also allows for customizing the Tenant view, including setting the tenant’s Home screen and “View More” access.

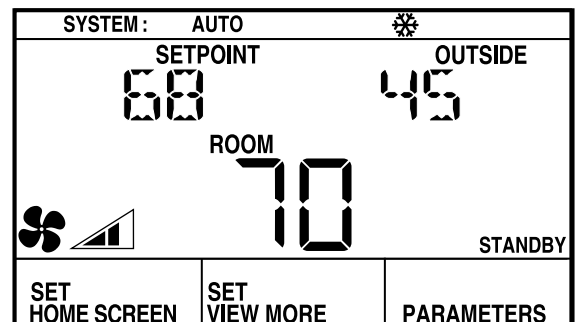

M27357

Fig. 7. Sample Contractor Home screen display with System Status, Setpoint, Outside Temperature, and Room Temperature (predominant).

CONTRACTOR HOME SCREEN SOFTKEYS

The three softkeys on the Contractor Home screen (Fig. 7) provide the following:

SET HOME SCREEN - allows the contractor to choose among multiple Home screen options for the tenant.

SET VIEW MORE - allows the contractor to give additional parameter access (view only or adjustable) to the tenant.

PARAMETERS - allows the contractor to monitor and/or adjust parameters in the programmable controller.

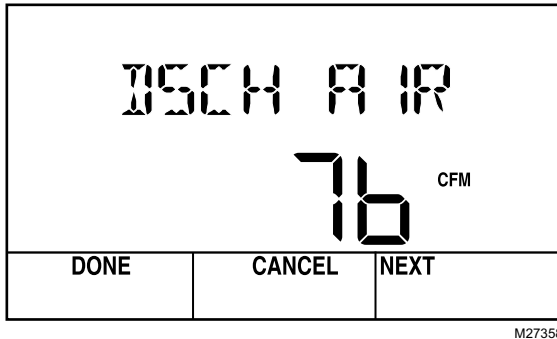

M27358

Fig. 8. Sample Contractor parameter display showing user-created discharge air parameter value.

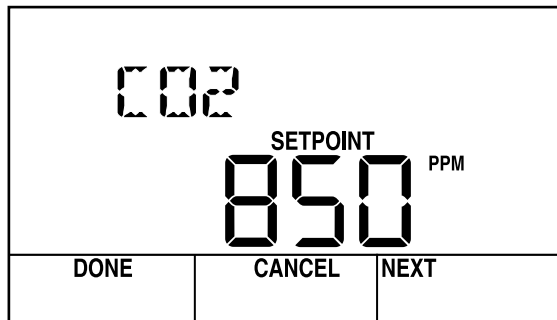

M27359

Fig. 9. Sample Contractor parameter display showing sensor setpoint value (CO₂ sensor from controller).

NOTE: Any configured parameter may be displayed.

TYPICAL SPECIFICATION

1. The wall module shall have an LCD display.
2. The wall module shall have a customizable home screen:
 - a. Shall have the option to show up to 3 parameter values on a single display.
 - b. Shall have the option to show occupied status.
 - c. Shall have the option to show system status.
 - d. Shall have the option to show fan status.
 - e. Shall have the option to show up to three of the following parameters:
 - room temperature, setpoint, outside temperature, room humidity, outside humidity, time of day.
 - f. Shall have the option to show on the home screen any single parameter in the controller, with a user defined 8 letter name.
3. The wall module shall offer access to all parameters necessary to balance a VAV system.
4. The wall module shall offer the ability to restrict access to parameter information with keypad enabled lock out and with optional 4 digit password protection (password on TR71 and TR75 only).
5. The wall module shall retain user configuration including setpoints after power outage.
6. The wall module shall use a two wire polarity insensitive connection for all communication and power needs.
7. The wall module shall offer the ability to access and adjust virtually all controller parameters.
8. The wall module shall offer the ability for the tenant to adjust override time period within the limits set by the contractor.
9. The wall module shall offer a communication jack for remote access to the network.
10. The wall module shall offer a $\pm 5\%$ on board humidity sensor (TR70-H, TR71-H, and TR75-H only).
11. The wall module shall be configured through the Honeywell WEBS-AX Workbench tool.
12. The wall module shall communicate with other devices using the Sylk bus protocol.
13. The wall module shall be compatible with LON and BACnet controllers.
14. The wall module shall offer the ability to view/edit the controller's schedule (TR75 only).
15. The wall module shall have the ability to display enumerated values as text.
16. The wall module shall have the ability to use the value of a parameter as the upper or lower limit of another parameter (TR75 only).

ComfortPoint™ is a trademark of Honeywell International Inc.
 LONMARK® is a trademark of the LonMark Association.
 BACnet® is a registered trademark of BACnet International.
 Spyder® is a registered trademark of Honeywell International Inc.
 Sylk® is a registered trademark of Honeywell International Inc.
 Zio® is a registered trademark of Honeywell International Inc.

By using this Honeywell literature, you agree that Honeywell will have no liability for any damages arising out of your use or modification to, the literature. You will defend and indemnify Honeywell, its affiliates and subsidiaries, from and against any liability, cost, or damages, including attorneys' fees, arising out of, or resulting from, any modification to the literature by you.

Automation and Control Solutions

Honeywell International Inc.
 1985 Douglas Drive North
 Golden Valley, MN 55422
 customer.honeywell.com

© U.S. Registered Trademark
 © 2014 Honeywell International Inc.
 63-1322-03 M.S. Rev. 05-14
 Printed in United States

Honeywell