

Fieldpiece[®]

Refrigerant Recovery Machine

OPERATOR'S MANUAL

Model MR45CAN (for models with Zero Stop)

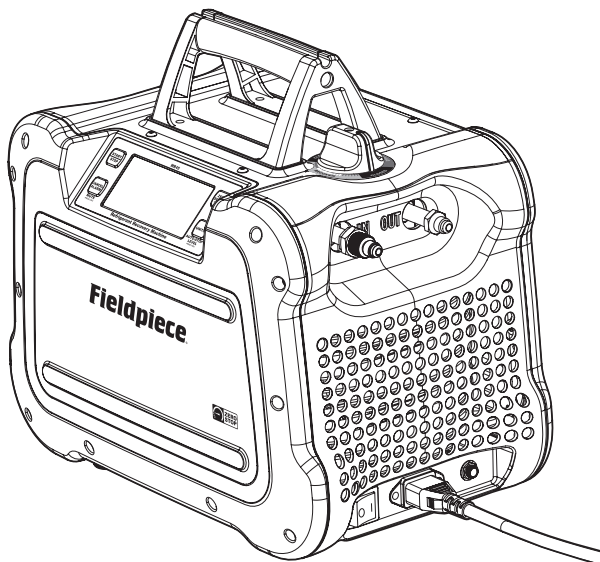

Contents

- Safety Information.** 4
 - Warnings
 - Caution

- Description** 8
 - Features
 - What's included

- Specifications** 10

- Certifications** 11
 - UL Verified Performance Data

- Tech Tips** 12
 - General
 - Setup
 - Operational

- Controls** 14
 - Display and Buttons
 - Status Icons and Messages
 - Port Routing Control
 - MR45 Refrigerant Flow
 - Dynamic Pressure Measurement

- Functions** 22
 - Self Test
 - Self Purge
 - Purging a Recovery Cylinder
 - 80% Overfill Sensor Cable Port
 - Direct Liquid/Vapor Recovery
 - Push/Pull Recovery

- Troubleshooting** 28
 - Status Messages
 - Other Symptoms

- Maintenance.** 30
 - General
 - Mesh Screen Filter

- Limited Warranty** 32
 - Obtaining Service

Safety Information

Read, understand, and follow this entire manual, with special attention given to Warning and Caution statements before operating this machine.

For use only by qualified and certified technicians in the safe use, handling, and transporting of refrigerants. This machine is designed to recover most CFC, HFC, HCFC, and some HFO refrigerants that have an A1 or A2L flammability rating only. Please refer to flammable refrigerant safety guides, regional codes and legislation for more information.

WARNING

FAILURE TO HEED THESE HAZARDS AND ACTIONS CAN RESULT IN SERIOUS INJURY OR DEATH:

- Do not operate in a wet location as electrical shock risk.
- Machine is only rated for use on 110VAC mains power
- Always use a grounded outlet
- Always wear Proper Protective Equipment (PPE), which includes gloves and safety glasses and earplugs
- Know proper safety and handling requirements of the refrigerant in the Safety Data Sheet (SDS)
- Avoid breathing refrigerant and oil vapors
- Handle hoses and equipment carefully as refrigerant is under high pressure and can cause frost bite
- Do not operate in or near explosive atmospheres
- Do not use with hydrocarbons (HC)
- Perform leak detection in accordance with recommended practice to verify working environment is free from leaking refrigerant as it can be toxic and or flammable
- Only work in well-ventilated areas (at least 4 air exchanges per hour)
- Ensure power and extension cords are in good working condition to prevent shock and spark hazards
- Prevent motor overheating by using 14AWG minimum and 50AWG maximum cord size

ADDITIONAL SAFETY INSTRUCTIONS FOR RECOVERING A2L REFRIGERANTS (e.g. R-32, R-1234yf, R-1234ze):

- Adhere to local occupational safety codes and possess detailed knowledge and skills when handling mildly flammable refrigerants
- Have emergency, evacuation, and fire protection plans
- Designate and monitor a Temporary Flammable Zone with a 3-meter perimeter
- Identify and disable all possible ignition sources within this zone
- Monitor air with a flammable refrigerant leak detector within this zone
- Ensure at least 5 air exchanges per hour within this zone

- Make power connection of the recovery machine and other equipment outside of the Temporary Flammable Zone
- Bond the recovery machine outlet port to the recovery tank's unpainted fitting with a grounding strap to dissipate static electricity build up during recovery process
- Ensure area around machine is free of debris that could enter the machine and cause accidental sparking
- Always remain in attendance and observant when the machine is running
- Do not mix flammable refrigerants with air
- Use an evacuated DOT recovery tank
- If system has a suspected leak, stop recovery at 0 psig/bar to prevent air from entering the recovery tank
- After recovery, purge system with 100% nitrogen before opening system for repair

CAUTION

FAILURE TO HEED THESE HAZARDS AND ACTIONS CAN CAUSE EQUIPMENT DAMAGE:

- Ensure that recovery machine, hoses, tank and other equipment are in good working condition
- If the power cable is damaged, it must be replaced by the manufacturer, its service agent, or similarly qualified persons in order to avoid a hazard
- Avoid overfilling recovery tanks by following refrigerant manufacturer's filling instructions and using a weight scale
- Avoid cross contamination (mixing) of refrigerants
- Ensure mesh screen filter is installed & clean (page 30)
- Use a filter drier on the input port and change it often to protect machine from contaminated refrigerants
- Never use an overfill sensor as the primary indicator of recovery cylinder fill status; explosion risk. Use a scale as the primary indicator.
- Ensure power switch is OFF before plugging into power
- Disconnect power and allow fan to stop before opening or servicing the recovery machine
- Perform a self test periodically (page 22)

Intentionally Blank

Description

The MR45 is the first recovery machine with a smart variable speed DC motor that accelerates during vapor recovery. It has an oversize compressor that allows you to pump refrigerant more easily and quietly than ever before. Connect your hoses without lifting the pump off the ground. View status messages and pressures directly on the large backlit display.

Its lightweight size allows you to easily transport the machine to and from the job site. Turn the single rubberized control valve to route refrigerant through MR45, and use the self-purge function to pump the last traces of refrigerant into the recovery cylinder instead of leaving it in the machine or releasing it into the environment.

Class A2L compatibility for a wide range of jobs. To avoid contaminating recovered refrigerant, MR45 automatically stops at 0 psig/bar by default.

Features

- **Lightweight (22 lbs/10 kgs)**
- **Smooth and Fast Operation (1 HP DC Motor)**
- **Digital Display with Status Messages**
- **Reliable Rubberized Construction**
- **Easy to Access Port Design**
- **Hex Nut Secures Input Port During Hose Removal**
- **80% Overfill Sensor Protection Port**
- **Power Cord Storage**
- **Ceramic Cylinders**
- **Class A2L Refrigerant Compatible**
- **Zero Stop (3 Selectable Auto-stop Levels)**
- **Self Purge**
- **Wide Operating Voltage (95 to 130 VAC)**
- **UL Verified to Section 608 of EPA Clean Air Act**
- **UL Verified to AHRI Standard 740**

What's Included

MR45CAN Refrigerant Recovery Machine
10 Extra Mesh Screens for Input Port
3 Extra O-rings for Input Port
65 cm IEC Power Cord
Operator's Manual
1 Year Warranty

Specifications

Display: 2 x 10000 count LCD with status messages

Backlight: Blue color

Measurement Rate: 3.3 times per second, nominal

Auto-stop Levels: 0 psig (default), -10 inHg, -20 inHg
(-25 cmHg, -50 cmHg)

Input Port Pressure Sensor Range:

-30inHg to 600 psig (-76 cmHg to 4100 kPa)

Output Port Pressure Sensor Range:

-30 inHg to 600 psig (-76 cmHg to 4100 kPa)

High Pressure Cutoff: 558 psig (3850 kPa), nominal

Resolution and Units: 1 psig (1 inHg), 0.05 bar (2 cmHg),
0.01 Mpa (2 cmHg), 5 Kpa (2 cmHg)

Pressure Sensor Accuracy:

± 0.5 inHg, ± 1.3 cmHg (Vacuum)

± (0.6% of reading +2 psig), ± (0.6% of reading +14 kPa)

Final Recovery Vacuum: 14.9 inHg, 38 cmHg

Compressor: Twin cylinder reciprocating (oil-less)

DC Motor: 1 HP (variable smart speed)

Power Source: 120 VAC @ 60 Hz 1 phase

Nominal Current Draw: 12.0 AAC

Valve: Single dual-route ball valve

Input Port Filtration: 9 mm mesh screen, stainless

Dimensions: 14.8 in x 9.8 in x 13.5 in (376 mm x 250 mm x 344 mm)

Weight: 22 lbs, (10kg)

Operating Environment: 32°F to 104°F (0°C to 40°C)

Storage Environment: -4°F to 140°F (-20°C to 60°C)

Common Representative Refrigerants: R12, R22, R32*, R134A,

R143A*, R401A, R401B, R401C, R402A, R402B, R404A, R407A,

R407B, R407C, R407D, R408A, R409A, R410A, R448A, R452A,

R454B*, R500, R502, R507, R509, R1234YF*, R1234ZE*

* Class A2L refrigerants

US Patent: www.fieldpiece.com/patents

Certifications



WEEE (Do not dispose through typical waste streams.)

IN ACCORDANCE WITH SECTION 608 OF THE CLEAN AIR ACT:
THIS EQUIPMENT HAS BEEN CERTIFIED BY UNDERWRITERS
LABORATORIES INC. TO MEET EPA'S MINIMUM REQUIREMENTS FOR
RECOVERY EQUIPMENT INTENDED FOR USE WITH CATEGORY III, IV,
AND V REFRIGERANTS OUTLINED IN AHRI 740, TABLE 4. <SA44565>

UL Verified Performance Data

Refrigerant	R22	R134A	R407C	R410A
Liquid Recovery (kg/min)	4.7	2.9	5.1	5.6
Vapor Recovery (kg/min)	0.28	0.28	0.33	0.33
Final Recovery Vacuum (kPa)	50.8	50.8	50.8	50.8
Residual Trapped Refrigerant (kg)	0.005	0.008	0.004	0.005
High Temp (104°F) Vapor Recovery (kg/min)	0.40	-	-	-

Tech Tips

General

1. Store in the self purge or recover position. Do not store in the CLOSED position as trapped air and refrigerant can expand and damage components.
2. For extended storage, purge with nitrogen, set to RECOVER, and screw non-sealing caps onto the ports.
3. Recovery machines are not vacuum pumps and should not be used for deep evacuations.
4. Do not run the machine without the mesh screen filter (page 30). Doing so will void the warranty and damage the machine.
5. Understand the refrigerant safety data sheet (SDS).

Setup

1. Know the refrigerant of the system and make sure your recovery cylinder matches that type.
2. Hoses:
Short as possible (3/8" hose with 1/4" fitting).
Core depressors removed.
Ball valve shutoffs instead of low loss fittings.
Replace if worn.
3. Manifold gauges are not necessary for recovery but can make it more convenient and increase speed by having 2 system hook ups.
4. Use a Schrader valve core removal tool to temporarily remove valve cores from service valves.
5. Use the push-pull method if recovering over 30 lbs (14kg).
6. Evacuate your empty recovery cylinders to -29.6 inHg (-75 cmHg) before use.
7. Know how much refrigerant you expect to recover before starting.

8. Ensure there's enough room in the recovery cylinder to not exceed 80% filled during the job, or monitor and have a second cylinder ready.
9. Always purge hoses before recovery. If cylinder is too hot, use an ice bath to reduce the temperature and pressure of the cylinder.
10. If cylinder pressure is higher than expected, you can purge non-condensables into another cylinder (page 23).

Operational

1. Recover as much liquid as possible before recovering vapor.
2. Recovery is faster when the recovery cylinder is cooler.
3. You can use a heat gun to warm refrigerant lines to boil trapped refrigerant.
4. Recover from both suction and liquid lines at the same time for faster vapor recovery.

Controls

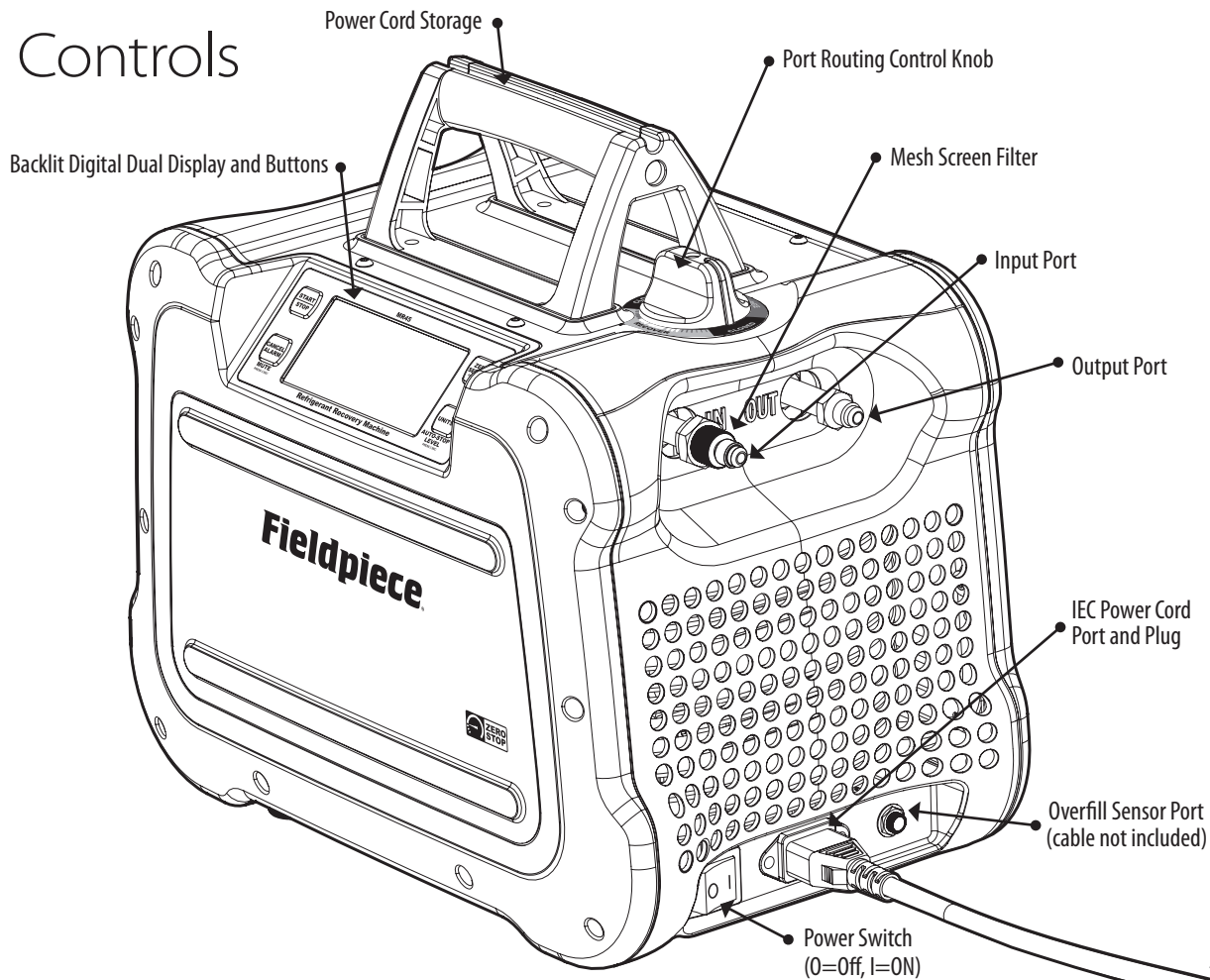

Display and Buttons

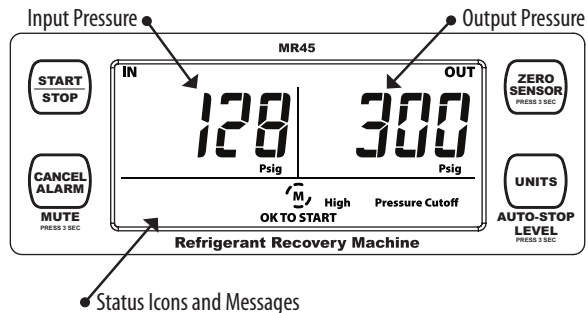

START/STOP

Start or Stop the motor.

ZERO SENSOR (press 3 seconds)

Zero pressure sensors. Ports must be open to atmosphere.

CANCEL ALARM

Cancel alarm currently sounding (temporarily mute).

MUTE (press 3 seconds)

Toggle mute for all sounds (setting is saved).

UNITS

Select pressure/vacuum units.

AUTO-STOP LEVEL (press 3 sec to enter setup)

Once entered, press to change the pressure/vacuum level that triggers the first automatic stop: 0 psig (default), -10 inHg, -20 inHg (-25 cmHg, -50 cmHg). Wait 5 seconds to exit setup, automatically saving desired setting.

Status Icons and Messages

The icon rotates when the motor is running.

The icon is shown when MR45 is set to MUTE.

OK TO START

Motor stopped. Temperatures, voltages, and pressures are currently safe to start the motor again.

COMPLETE/Low Pressure Cutoff

Motor stopped. Input pressure/vacuum reached one of three auto-stop levels for 10 seconds: 0 psig, -10 inHg vac, or -20 inHg vac (0 bar, -25 cmHg vac, or -50 cmHg vac)

Tank 80% Full

Motor stopped. Overfill sensor triggered by liquid level of refrigerant in the recovery cylinder.

Input Closed

Cannot zero pressures. Open input port.

Output Closed

Cannot zero pressures. Open output port.

High Voltage Warning

Motor stopped. Voltage was above 130 VAC.

Low Voltage Warning

Motor stopped. Voltage was below 95 VAC.

High Pressure Cutoff

Motor stopped. Output (cylinder) approached dangerous pressure.

Motor Fault 1

Motor stopped. Motor temp. measured above operating range.

Motor Fault 2 (“throttle” shows on display)

Motor stopped. Motor current (amps) rose above operating range. Throttle RECOVERY to reduce cylinder pressure (page 19).

Motor Fault 3

Motor stopped for unknown reason.

Fault 3 (“PLUG O.F.S” shows on display)

80% overfill sensor not detected. Plug sensor cable into cylinder.

Port Routing Control

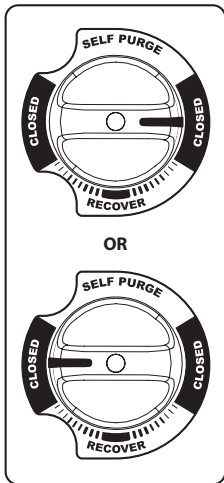

CLOSED

- Input and Output closed.
- Set to either closed position to close off both ports during setup or before purging.

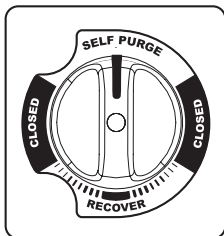

SELF PURGE

- Input closed, Output open.
- After recovery is complete and the motor has stopped, set to CLOSED before you START the purge.
- Press START and slowly rotate to SELF PURGE, closing the IN port and purging MR45.



RECOVER

- Input and Output fully open.
- Set to this fully open position for most of the recovery process.

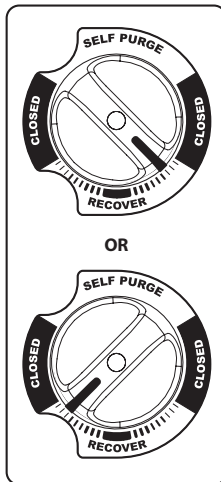

RECOVER (throttled)

- Input and Output partially open.
- Rotate away from RECOVER in either direction to reduce liquid slugging if knocking occurs. This slows the flow of refrigerant so the machine operates more smoothly.
- Only throttle as much as needed for smooth operation.

MR45 Refrigerant Flow

Refrigerant liquid and vapor are pulled through the machine by the pressure difference created by the compressor. For maximum performance, increase the IN pressure and reduce the OUT pressure. See Tech Tips (page 12).

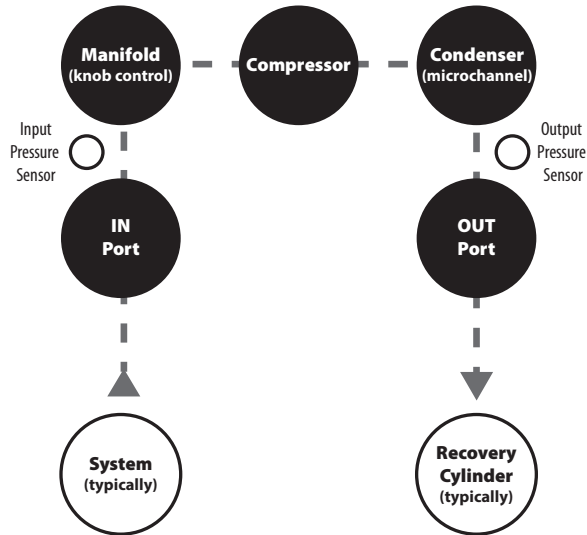

Dynamic Pressure Measurement

MR45 pressure readings are designed only for monitoring pressures. Do not use MR45 for diagnostic pressure measurements.

If a system's pressure is stable, MR45 pressure readings will be close to your other pressure gauges.

If a system's pressure is changing, pressure measurements at different locations within that system will be different. For every 3 feet of 1/4" hose, the pressure may have a difference of approximately ± 20 psig (± 150 kPa).

Functions

Self Test

Perform this test to ensure the high pressure cutoff and pump are operational.

1. Set knob to RECOVERY.
2. Open IN port to air.
3. Connect a ball valve to OUT port. (Included caps are not sealed.)
4. Close the ball valve.
5. Press START to create a pressure at the OUT port.
6. Press START a second time to continue if MR45 stops automatically after 10 seconds at 0 psig (0 kPa), the default auto-stop level.
7. MR45 is working well if High Pressure Cutoff occurs around 550 psig (3800 kPa) within 45 seconds. Cutoff time can increase if a hose is placed in front of your ball valve.

Self Purge

Use the SELF PURGE feature at the end of every recovery to pump the last bit of refrigerant out of MR45. Benefits include increased machine life, reduced environmental impact, and most importantly, prevention of refrigerant mixing.

1. After recovery is complete, set knob to CLOSED.
2. Press START and slowly rotate the knob to SELF PURGE to empty MR45 into the recovery cylinder without any sudden changes in pressure. This closes the IN port and routes the MR45 condenser to the intake of the MR45 compressor.
3. Once the machine reaches an auto-stop level (page 16) for 10 seconds, the motor stops automatically.

Purging a Recovery Cylinder

When the cylinder pressure is higher than expected you may have non-condensables at the top of the cylinder. Use a second deeply evacuated cylinder to pull out the non-condensables.

1. Leave pressurized cylinder undisturbed overnight.
2. Use a vacuum pump to evacuate another cylinder.
3. Use your manifold gauges to connect the closed vapor ports of the two cylinders.
4. Measure the vapor temperature of the pressurized refrigerant cylinder.
5. Use a P/T chart or digital manifold to find specified pressure.
6. Open the evacuated vapor port.
7. Open (purge) the pressurized vapor port until pressure is reduced to 5 psi above specified pressure.
8. Close valves.
9. If desired, repeat after 15 minutes to allow the tank to settle again.

80% Overfill Sensor Cable Port

Always use a scale as the primary indicator of how much refrigerant is in a container. An 80% overfill sensor (O.F.S.) cable (sold separately) may be connected to the 6.35mm (1/4") port as an optional secondary indicator.

1. Connect the overfill sensor cable to MR45.
2. Connect the overfill sensor cable to an equipped recovery cylinder.
3. See pages 24-27 for recovery setup and operation.
4. MR45 automatically stops when triggered by the overfill sensor.

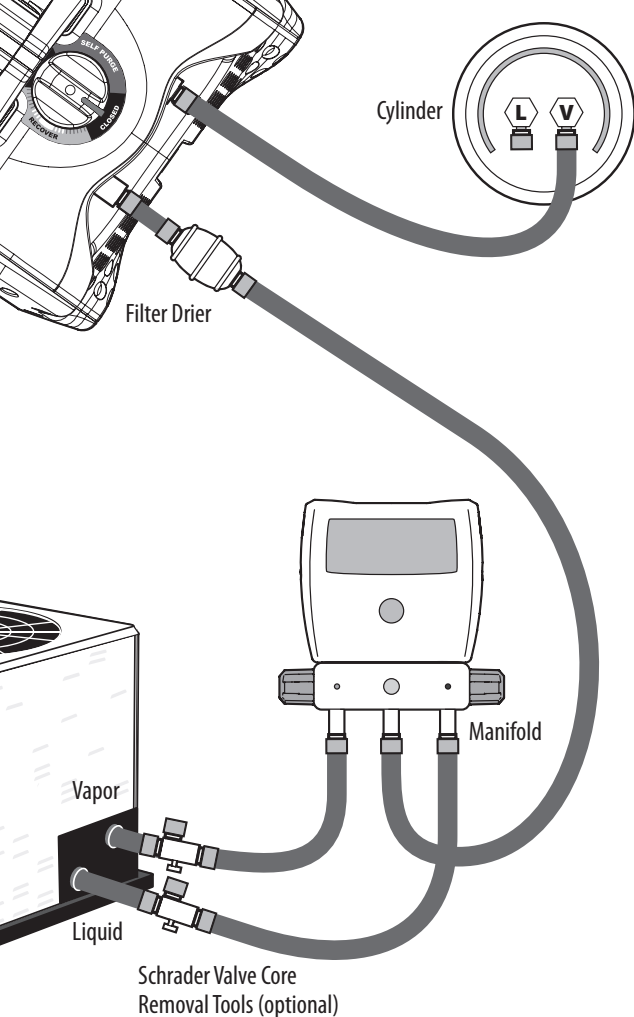

Direct Liquid/Vapor Recovery

This is the typical recovery method. Vapor and liquid lines are routed through your manifold, into MR45, and out to the recovery cylinder.

CAUTION: Understand all class A2L refrigerant warnings and notices if applicable (pages 4-6)

1. Close valves of recovery cylinder, MR45, and manifold.
2. Set up as shown in the diagram.
3. Open valves of hoses and removal tools.
4. Set MR45 to RECOVER.
5. Open high side of manifold for liquid recovery.
6. To purge air from hoses, briefly unseat hose fitting at cylinder until vapor is seen. Unseat hose fitting at low side of manifold to purge low side hose.
7. Fully open vapor valve of recovery cylinder.
8. Press START to begin recovery.
9. Adjust the knob as needed to throttle refrigerant flow if liquid slugging (knocking) occurs.
10. When liquid recovery is complete, open low side of manifold for vapor recovery.
11. MR45 stops automatically at one of three auto-stop levels: 0 psig (default), -10 inHg, -20 inHg (0 bar, -25 cmHg, -50 cmHg). If needed, press START to continue recovering until the next level is reached. Press STOP to manually halt recovery at any time. (If pressure rises back above a selected auto-stop level it re-activates that auto-stop level).
12. Set knob to CLOSED. Press START and slowly rotate to SELF PURGE to empty MR45 (stops automatically).
13. Close manifold and cylinder valves after self purge is complete.
14. Remove hoses from MR45, set knob to RECOVER, and cap ports.

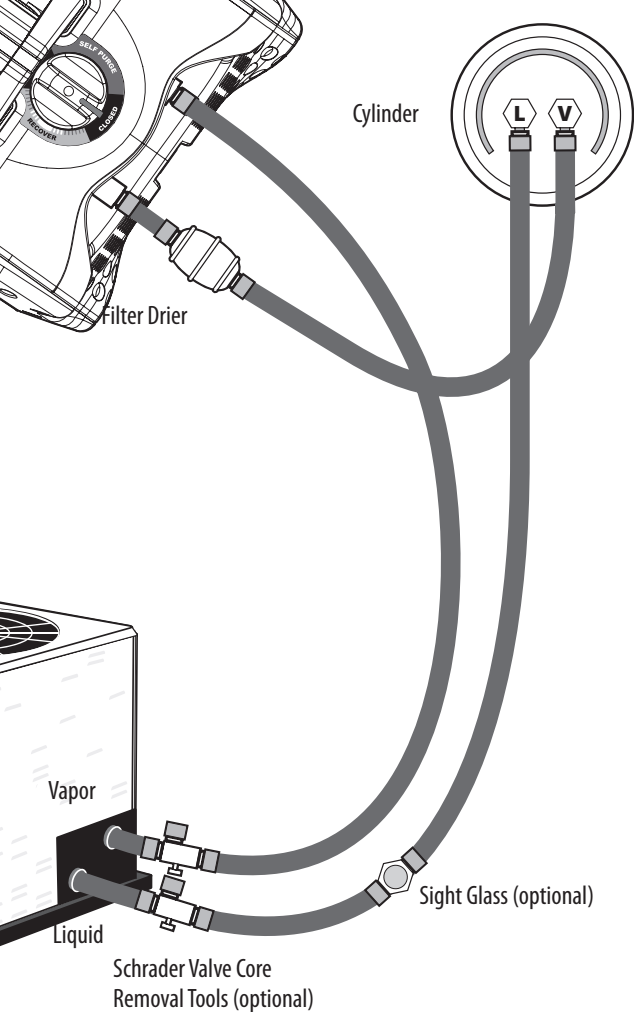

Push/Pull Recovery

This method is only for larger systems with at least 30 lbs (14 kg) of liquid refrigerant. It's used to recover liquid before recovering vapor.

CAUTION: Understand all class A2L refrigerant warnings and notices if applicable (pages 4-6).

1. Close valves of recovery cylinder and MR45.
2. Set up as shown in the diagram.
3. Open valves of liquid hose and removal tool at liquid system port.
4. To purge air from system liquid hose, briefly unseat hose fitting at cylinder's liquid port until vapor is seen.
5. Fully open liquid valve of recovery cylinder and allow to pressurize.
6. Set MR45 to RECOVER.
7. Press START to begin recovery.
8. Fully open vapor valve of recovery cylinder.
9. To purge air from hoses briefly unseat hose fitting at vapor system port until vapor is seen.
10. Open valves of vapor hose and removal tool at vapor system port.
11. When liquid recovery is complete, press STOP to stop motor.
12. Close all valves and proceed to Direct Vapor Recovery (page 25).

Troubleshooting

Status Messages

Tank 80% Full

Overfill sensor indicated the recovery cylinder is full. Replace recovery cylinder.

Input Closed

Cannot zero the displayed pressure because pressure sensor not open to atmosphere. Open input port.

Output Closed

Cannot zero the displayed pressure because pressure sensor not open to atmosphere. Open output port.

High Voltage Warning

Voltage was above 130 VAC. Motor stopped. Ensure power network voltage is between 95 and 130 VAC @ 60 Hz.

Low Voltage Warning

Voltage was below 95 VAC. Motor stopped. Check power network to ensure voltage is between 95 and 130 VAC @ 60 Hz.

High Pressure Cutoff

Output (cylinder) reached dangerous pressure. Motor stopped. Ensure all valves after the output port are open. The cylinder may need to be cooled or replaced to reduce pressure.

Low Pressure Cutoff

Input reached final recovery vacuum. Motor stopped. It's normal to see this after RECOVERY or SELF PURGE is complete. If unexpected, ensure valves before the input port are open and the knob is not set to CLOSED.

Motor Fault 1

Motor temperature measured above operating range. Motor stopped. Extremely high ambient temperature, extended liquid recovery time, or high cylinder pressure can be the cause. Allow time for the motor to cool down before resuming, and throttle the RECOVERY (page 19).

Motor Fault 2 (throttle" shows on display)

Motor current (amps) rose above operating range. Motor stopped. Extremely high ambient temperature, harsh liquid slugging, extended recovery time, or high cylinder pressure can be the cause. Throttle RECOVERY and start the motor. If fault occurs again, throttle even more and start the motor (page 19).

Motor Fault 3

Motor stopped for unknown reason. If this occurs repeatedly, there may be something wrong with MR45.

Fault 3 ("PLug O.F.S" shows on display)

Check for loose connection. Overfill sensor may be broken. Verify overfill with scale. If overfill sensor is bad, mark tank for disposal.

Other Symptoms

MR45 never reaches -10 inHg or -20 inHg.

Press START to continue recovery if auto-stop level was reached.

Check for a leakage before the input port.

For -10 inHg, the recovery cylinder should be below 475 psig.

For -20 inHg, the recovery cylinder should be below 230 psig.

Input port shows frost or signs of leakage.

Ensure the grooved input fitting is hand tight before tightening the hex nut (page 30).

Recovery is slower than normal.

There could be an input blockage. Check mesh screen filter for blockage. Ensure knob is set to RECOVER.

Display does not turn on when plugged in.

Ensure power cord and outlet are okay.

Ensure power switch is flipped ON after plugging into power.

Excessive noise during recovery or SELF PURGE.

MR45 is experiencing a high load. Slowly rotate the knob of MR45 to throttle the refrigerant flow.

Overfill sensor not working correctly.

Check for loose connection. Overfill sensor may be broken. Verify overfill with scale. If overfill sensor is bad, mark tank for disposal.

Maintenance

General

Wipe with damp cloth to clean the exterior.
Do not use solvents.

To extend the life of internal seals, occasionally pump a teaspoon of mineral oil through MR45.

Mesh Screen Filter

When the mesh screen filter becomes dirty and clogged, it means it's working to keep your MR45 working well for a long time. You need to clean or replace this screen often. Visit our website for information on obtaining extra mesh screens.

1. Loosen (counter clockwise) the securing hex nut on the IN port.
2. Unscrew (counter clockwise) the grooved input fitting.
3. Clean or replace the mesh screen.
4. Hand tighten (clockwise) the grooved input fitting.
5. Tighten (clockwise) the securing hex nut with 1/8 turn with a wrench.

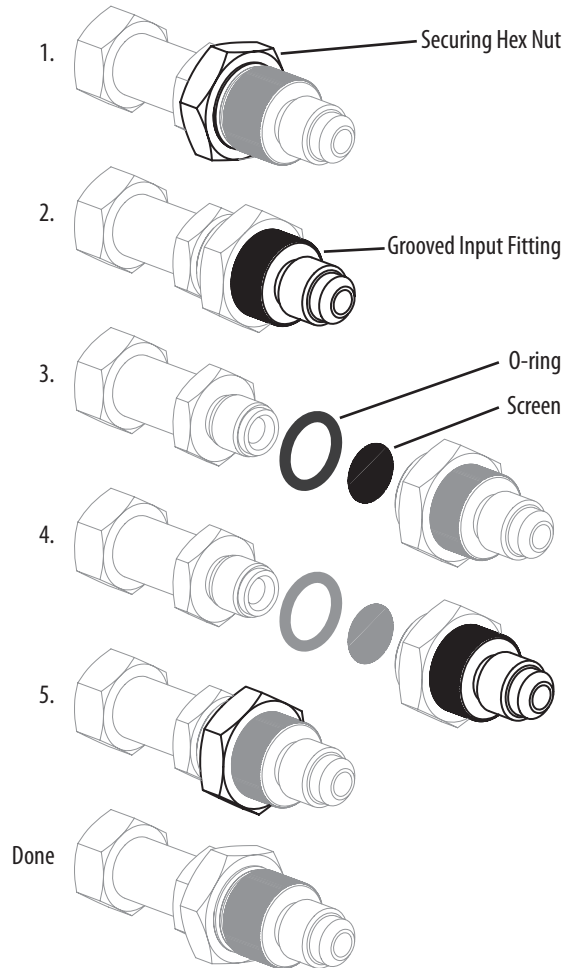

Limited Warranty

This machine is warranted against defects in material or workmanship for one year from date of purchase from an authorized Fieldpiece dealer. Fieldpiece will replace or repair the defective unit, at its option, subject to verification of the defect.

This warranty does not apply to defects resulting from abuse, neglect, accident, unauthorized repair, alteration, or unreasonable use of the machine.

Any implied warranties arising from the sale of a Fieldpiece product, including but not limited to implied warranties of merchantability and fitness for a particular purpose, are limited to the above. Fieldpiece shall not be liable for loss of use of the machine or other incidental or consequential damages, expenses, or economic loss, or for any claim of such damage, expenses, or economic loss.

State laws vary. The above limitations or exclusions may not apply to you.

Obtaining Service

Visit www.fieldpiece.com/rma for the latest information on how to obtain service. Warranty for products purchased outside of the U.S. should be handled through local distributors. Visit our website to find your local distributor.

Intentionally Blank

Intentionally Blank

MR45CAN